

NOTICE

*Please make sure that you have all parts indicated and they are in good condition before you begin assembly of this item. Refer to part list and hardware list below for guidance.

*This item should be assembled on a soft surface to prevent scratching the finish during assembly.

*This item may require periodic tightening.

*If you are having difficulty, our friendly Customer Care team is always here to help. Please email customersupport@safavieh.com.

PREPARATION

* Before beginning assembly of product, make sure all parts are present. Compare parts with part contents list and hardware contents list.

* If any part is missing or damaged, do not attempt to assemble the product.

* Estimated Assembly Time: 10 minutes.

* Tools Required for Assembly (included): Allen Key

CARE AND MAINTENANCE

OUTDOOR FURNITURE CARE

Store outdoor furniture indoors or cover well when not in use. Remove wooden furniture from standing water.

Dust regularly with small brush or vacuum.

Spills should be taken care of immediately before they harden or stain with a slightly dampened sponge.

UPHOLSTERY CARE

To prevent overall soiling, frequent vacuuming or light brushing is recommended. Cushions and pillows should be turned on a weekly basis.

Down-filled cushions should be brushed rather than vacuumed. Spot clean, using a mild water-free solvent or dry cleaning product. Only a professional cleaner should undertake a complete overall cleaning.

The use of steam or water-based cleaners may cause excessive shrinking or staining.



Model# PAT7069

Product Dimensions: 27.6" W x 29.1" D x 30.7" H

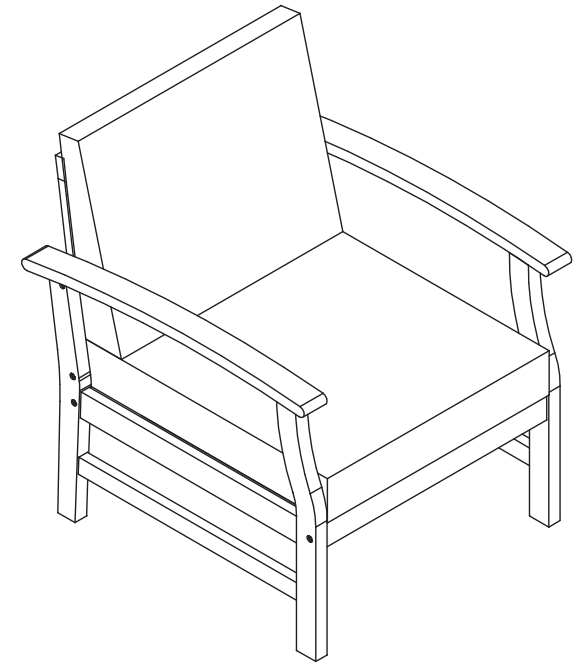







Weight Capacity : 200 lbs

Warning : Do not stand on chair

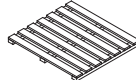
Warning : Do not over torque bolts / screws

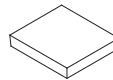

Part List and Hardware List

PIECE	DESCRIPTION	PICTURE	QUANTITY
A	Back Frame		1X
B	Seat Frame		1X
C	Leg Frame		2X
D	Font & Back Brace Bar		2X
E	Cushion Back		1X
F	Cushion Seat		1X
G	Screw	 M6 x 70	8X
H	Allen key	 LG4	2X

PREPARATION

- *Before beginning assembly of product, make sure all parts are present. Compare parts with package contents list and hardware contents list.
- *If any part is missing or damaged, do not attempt to assemble the product.
- * Estimated Assembly Time : 10 minutes.
- * Tools Required for Assembly (included): Allen Key
- * If you are having difficulty, our friendly Customer care team is always here to help. Please email customersupport@safavieh.com

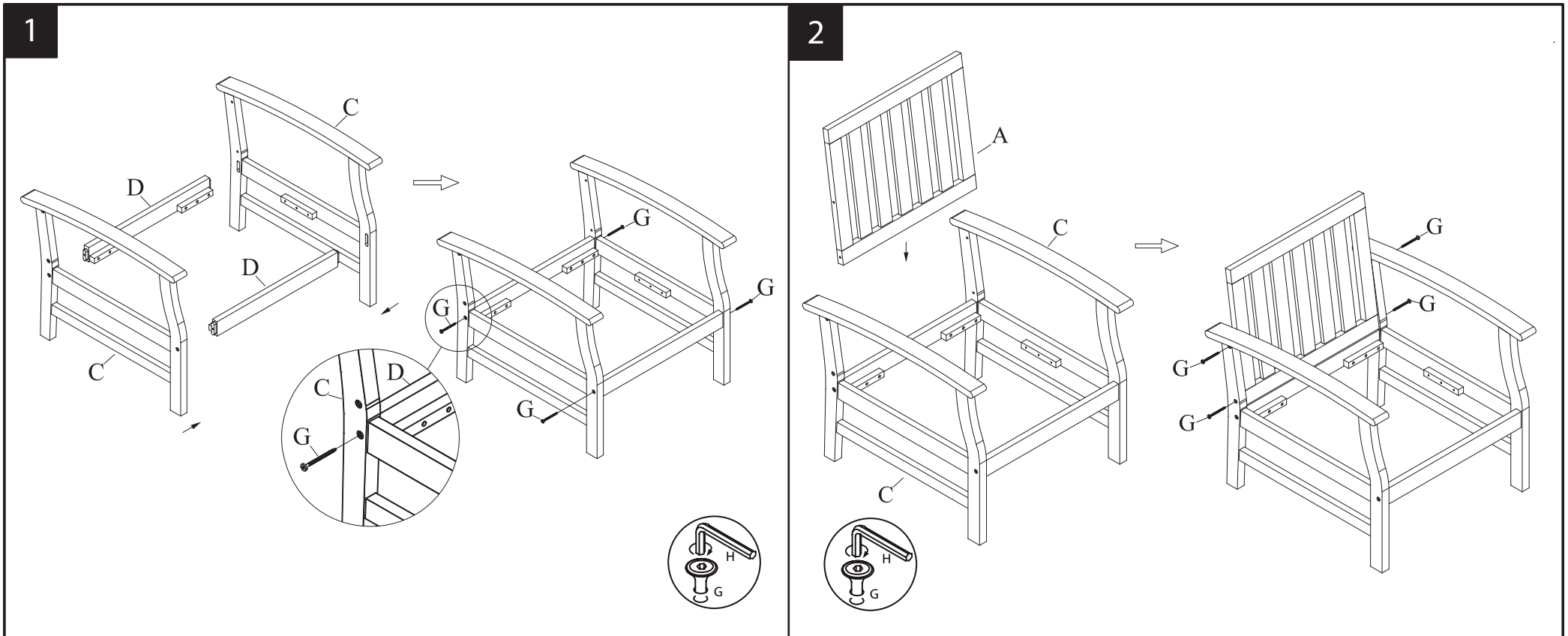

Step 1

Attach Front & Back Brace Bar (D) to Leg Frame (C) by using Screw (G) tighten with Allen Key (H).

Step 2

Attach Back Frame(A) to LegFrame (C) by using Screw (G) tighten with Allen Key (H).

PREPARATION

- *Before beginning assembly of product, make sure all parts are present. Compare parts with package contents list and hardware contents list.
- *If any part is missing or damaged, do not attempt to assemble the product.
- * Estimated Assembly Time : 10 minutes.
- * Tools Required for Assembly (included): Allen Key
- * If you are having difficulty, our friendly Customer care team is always here to help. Please email customersupport@safavieh.com

3

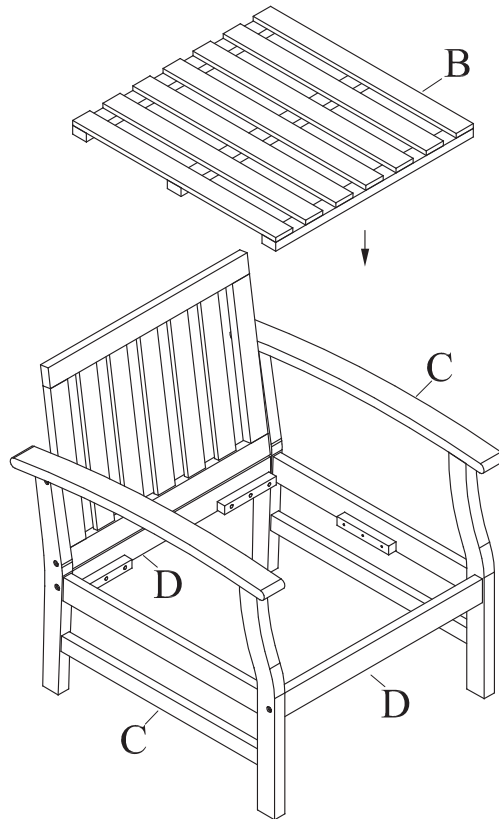

Step 3

Attach Seat Frame (B) to Front & Back Brace Bar (D) and Leg Frame (C).

4

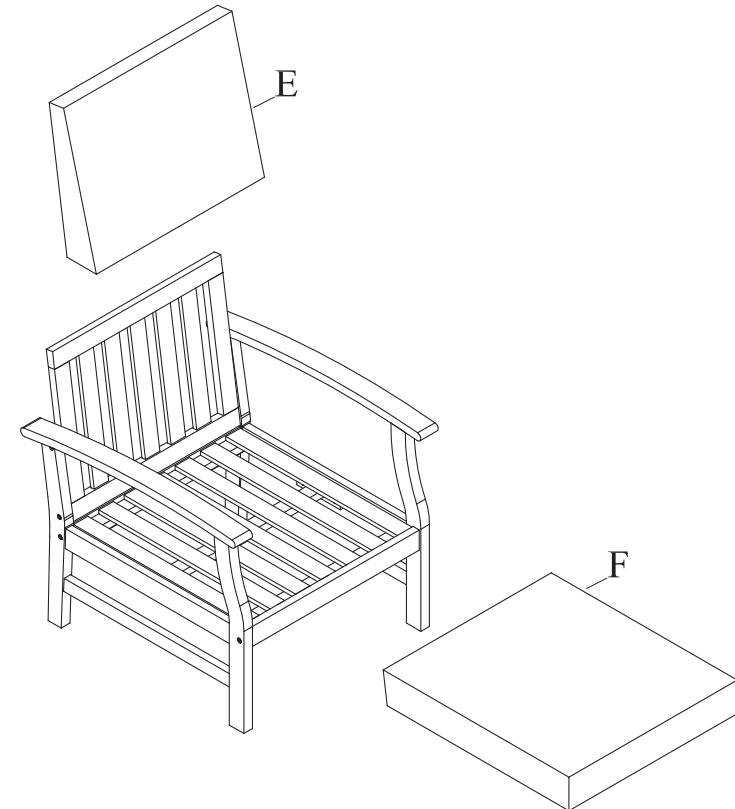

Step 4

Attach cushion seat and cushion back.

PREPARATION

- *Before beginning assembly of product, make sure all parts are present. Compare parts with package contents list and hardware contents list.
- *If any part is missing or damaged, do not attempt to assemble the product.
- * Estimated Assembly Time : 10 minutes.
- * Tools Required for Assembly (included): Allen Key
- * If you are having difficulty, our friendly Customer care team is always here to help. Please email customersupport@safavieh.com

5

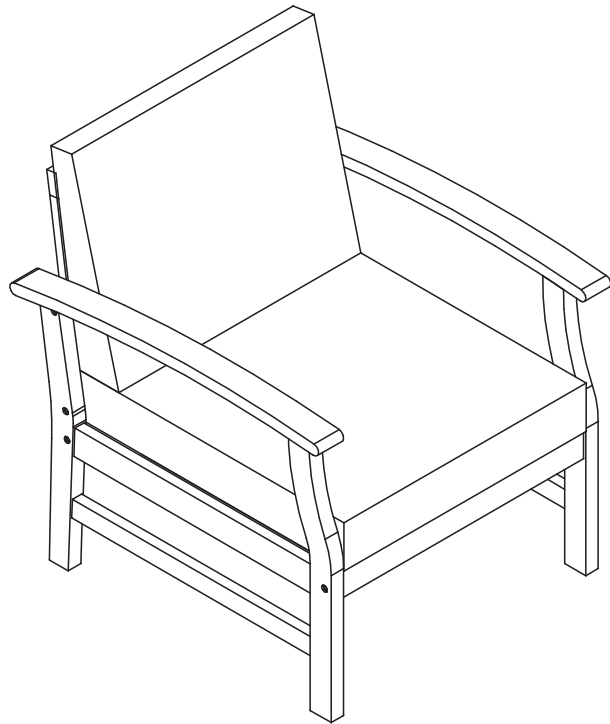

Step 5

Caution: This Chair can only be used on a flat, level surface

6

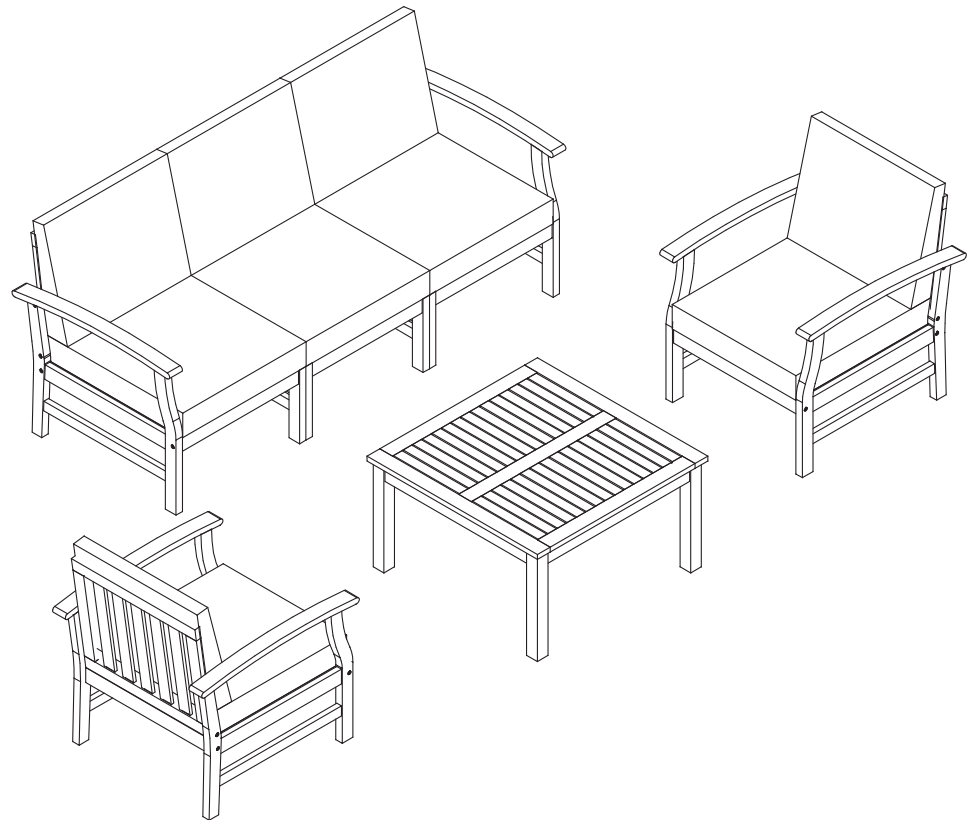

Step 6