





PARTS INCLUDING (Qty) :

- A1  — Plastic wire connector(3)
- A2  — Mounting screw(2)
- A3  — Mounting bracket(1)
- A4  — Ball nut(2)
- A5  — Canopy(1)
- A6  — 4.7"Tube&nut(1)
- A7  — Crystal lampshade(1)
- A8  — Lamp body(1)

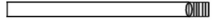
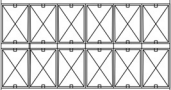
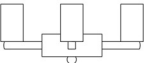
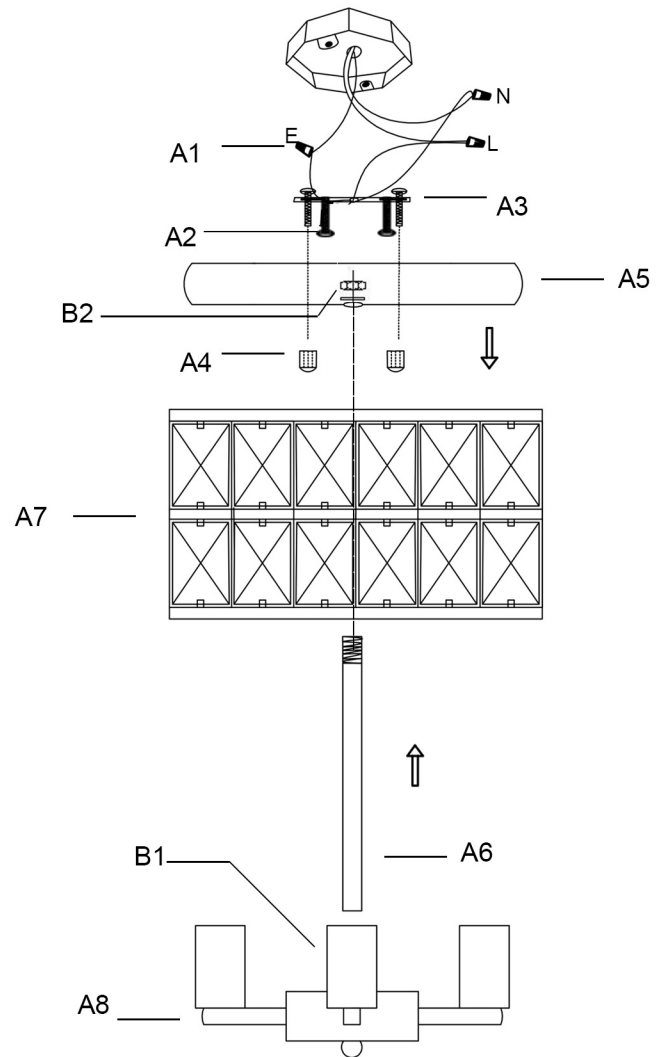

ASSEMBLY & INSTALLATION INSTRUCTIONS:

1. Carefully remove the fixture from the carton and check that all parts and accessories are included as shown in the above illustration
2. Make assembly
 - ① Push the threaded end of the arm(A6) into the corresponding hole(A8) and tighten(B1);
 - ② Pass the wire through the tube (A6) and Crystal lampshade(A7), secure the tube (A6) and canopy (A5) with the nut (B2);
 - ③ Fix the mounting bracket(A3) on the ceiling with mounting screw(A2);
 - ④ Make wire connections with connector(A1);
 - ⑤ Align the hole of the canopy(A5) with the screws of the mounting bracket(A3), and fix it with ball nuts(A4).
 - ⑥ Install the bulbs;
 - ⑨ **Check everything already is installed properly, then you could turn on the light.**

CLEANING

To clean, wipe fixture with a soft cloth. Do not use abrasive materials such as scouring pads or powders, steel wool or abrasive paper.

ORDERING PARTS

Keep this sheet for future reference, and in case you need to order replacement parts. All parts for this fixture can be ordered from place of purchase. Be sure to use exact wording from illustration when ordering parts.