

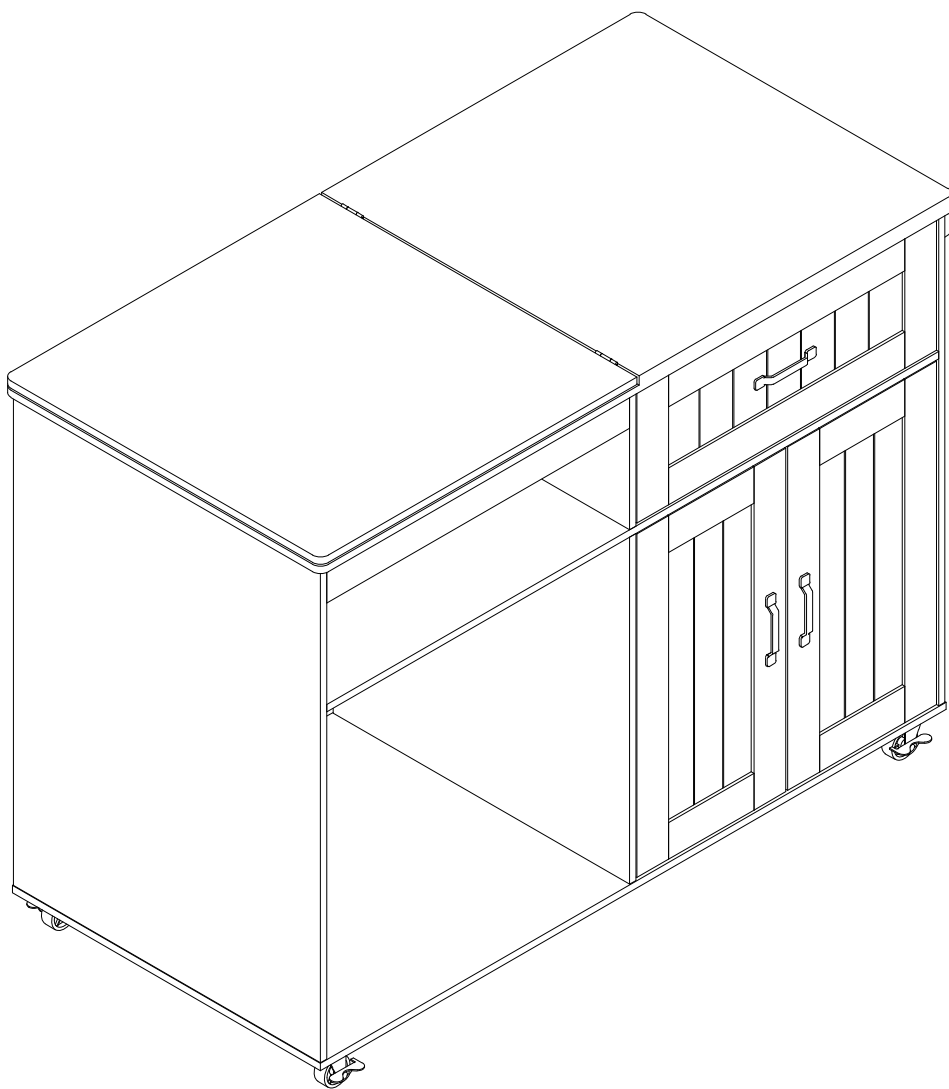

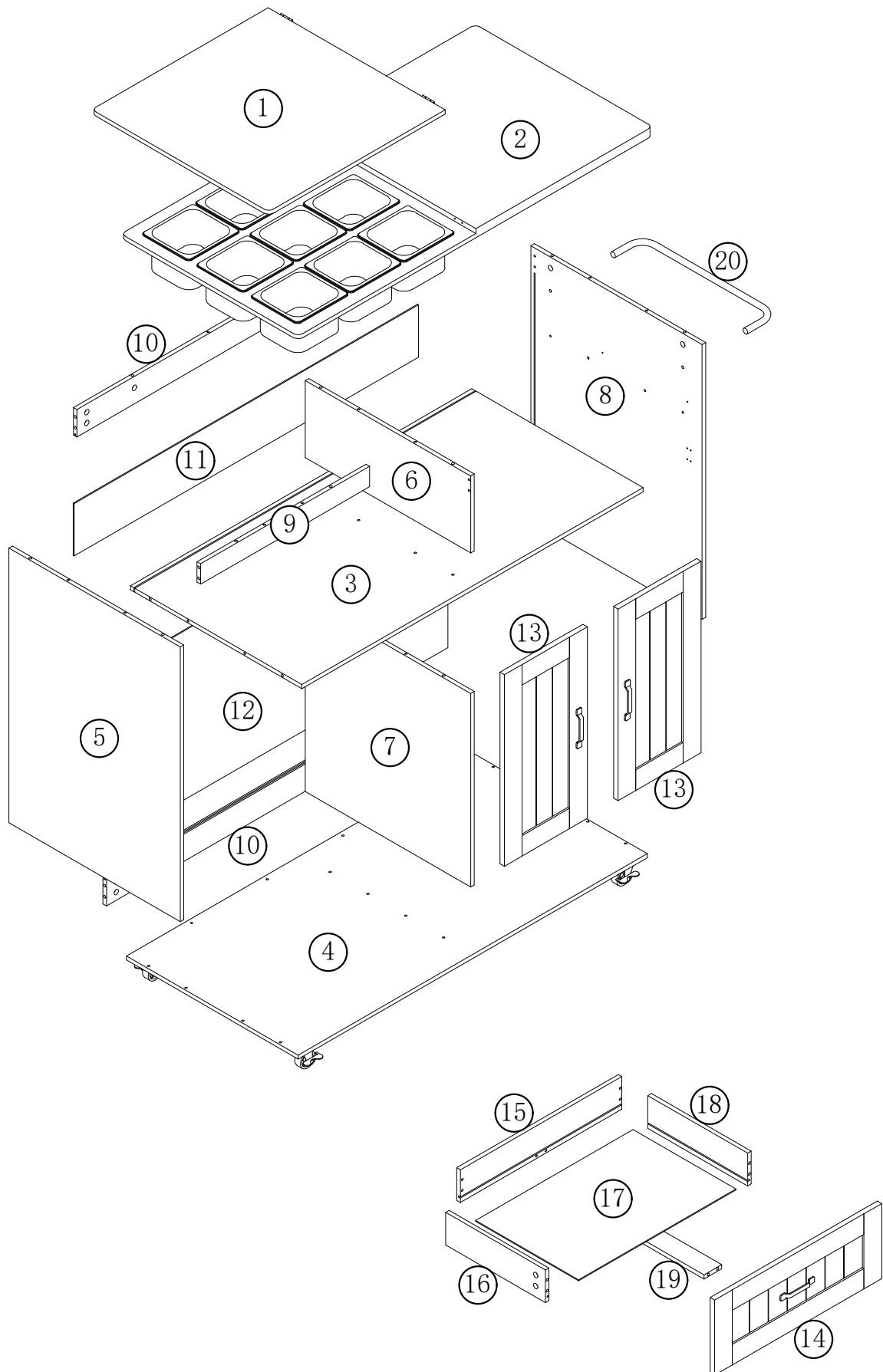









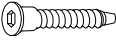



# ASSEMBLY INSTRUCTION

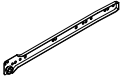
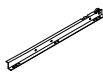
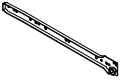
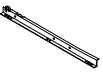

# ASSEMBLY INSTRUCTION

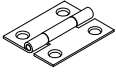
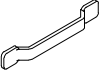
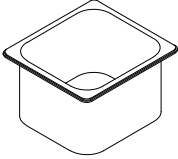

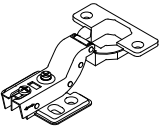
# ASSEMBLY INSTRUCTION

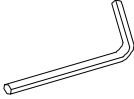
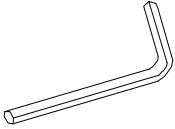
<p><b>A</b> M6x30mm</p>  <p>X2</p>	<p><b>B</b> M5x40mm</p>  <p>X14</p>	<p><b>C</b> M15x9mm</p>  <p>X36</p>	<p><b>D</b> KM6x40mm</p>  <p>X36</p>
<p><b>E</b> M4x18mm</p>  <p>X4</p>	<p><b>F</b> M4x8mm</p>  <p>X2</p>	<p><b>G</b> M3.5x12mm</p>  <p>X34</p>	<p><b>H</b> M3x12mm</p>  <p>X8</p>
<p><b>I</b> M4x12mm</p>  <p>X20</p>	<p><b>J</b> 6x50mm</p>  <p>X26</p>	<p><b>K</b> L 350mm</p> <p>CL  DL </p> <p>X1</p>	<p>CR  DR </p> <p>X1</p>
<p><b>L</b></p>  <p>X1</p>	<p><b>M</b></p>  <p>X2</p>	<p><b>N</b></p>  <p>X3</p>	<p><b>O</b></p>  <p>X9</p>
<p><b>P</b></p> <p>P1  X4</p> <p>P2  X1</p>	<p><b>Q</b></p>  <p>X4</p>	<p><b>R</b></p>  <p>M3  M4 </p> <p>X1</p>	

# ASSEMBLY INSTRUCTION

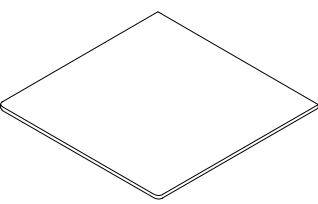
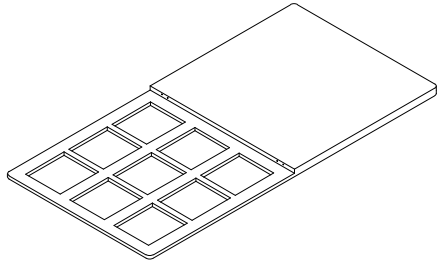
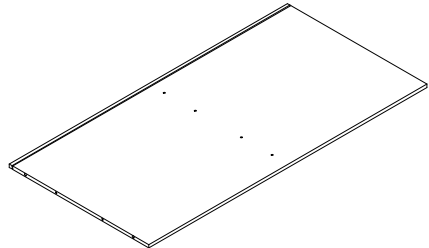
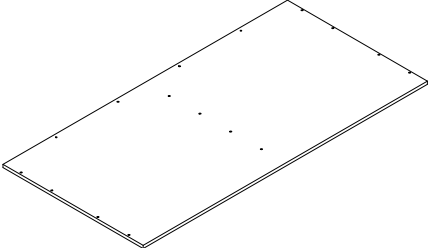
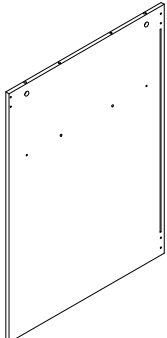
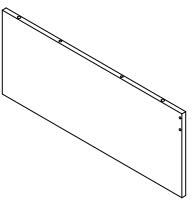
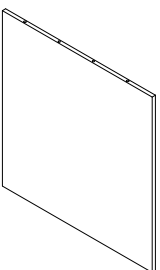
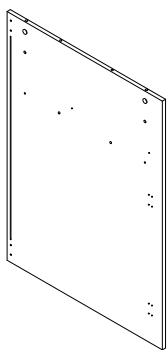
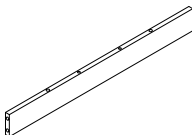
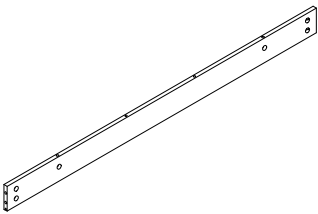
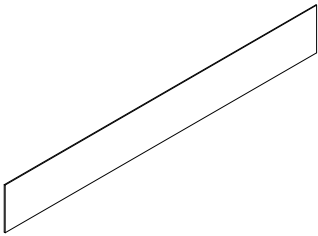
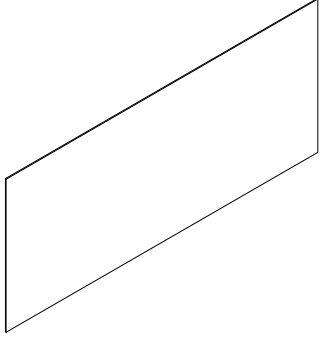
<p>①</p>  <p>X1</p>	<p>②</p>  <p>X1</p>	<p>③</p>  <p>X1</p>
<p>④</p>  <p>X1</p>	<p>⑤</p>  <p>X1</p>	<p>⑥</p>  <p>X1</p>
<p>⑦</p>  <p>X1</p>	<p>⑧</p>  <p>X1</p>	<p>⑨</p>  <p>X1</p>
<p>⑩</p>  <p>X2</p>	<p>⑪</p>  <p>X1</p>	<p>⑫</p>  <p>X1</p>

# ASSEMBLY INSTRUCTION

13

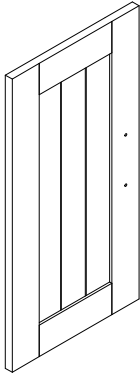

X2

14

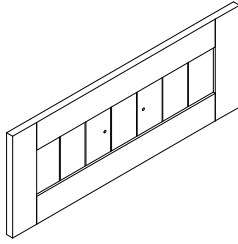

X1

15

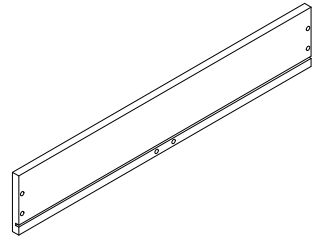

X1

16

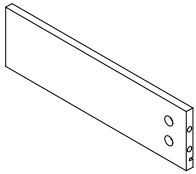

X1

17

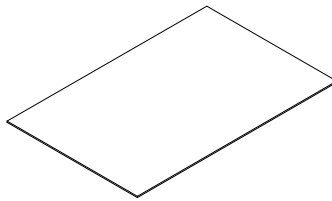

X1

18

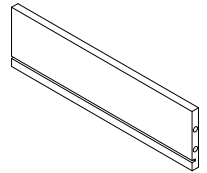

X1

19

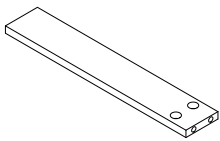

X1

20

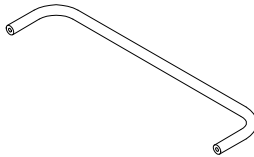



X1

# ASSEMBLY INSTRUCTION

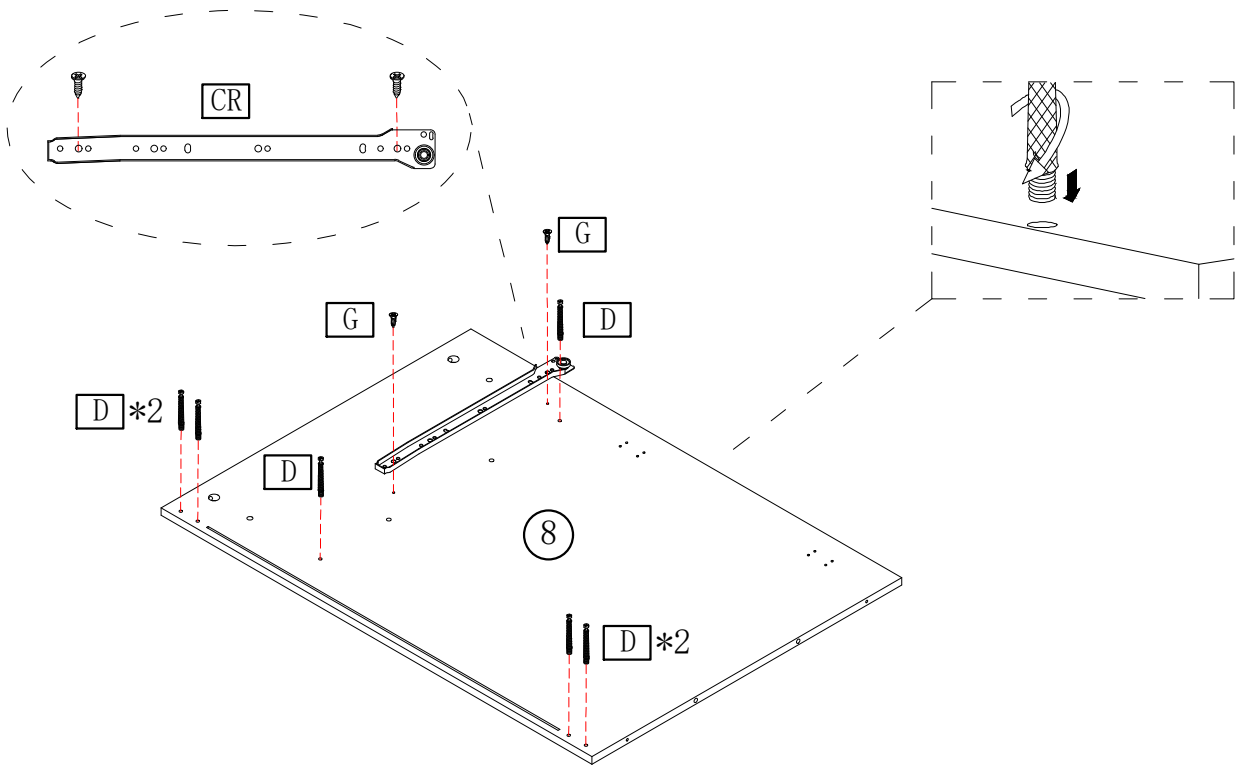
## STEP 1



<p><b>D</b> KM6*40</p>  <p>*6</p>	<p><b>G</b> M3.5*12</p>  <p>*2</p>	<p><b>K</b></p>  <p>CR *1</p>
---	---	--

## STEP 2

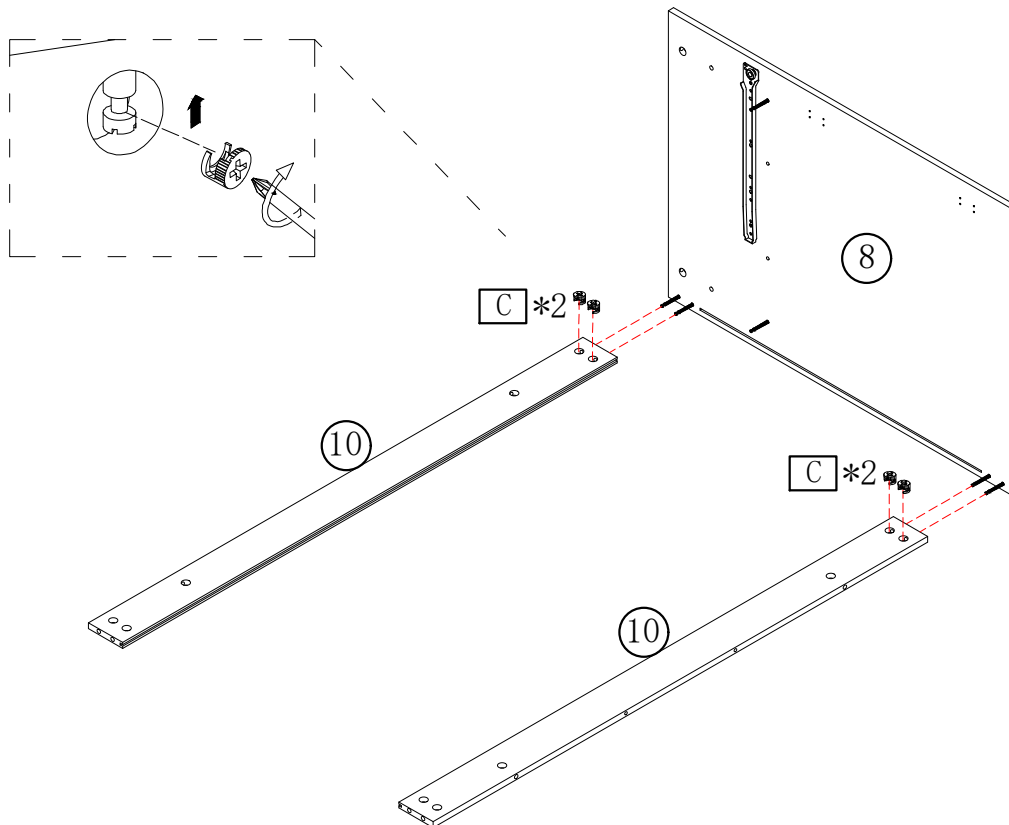



<p><b>C</b> M15*9</p>  <p>*4</p>
---

# ASSEMBLY INSTRUCTION

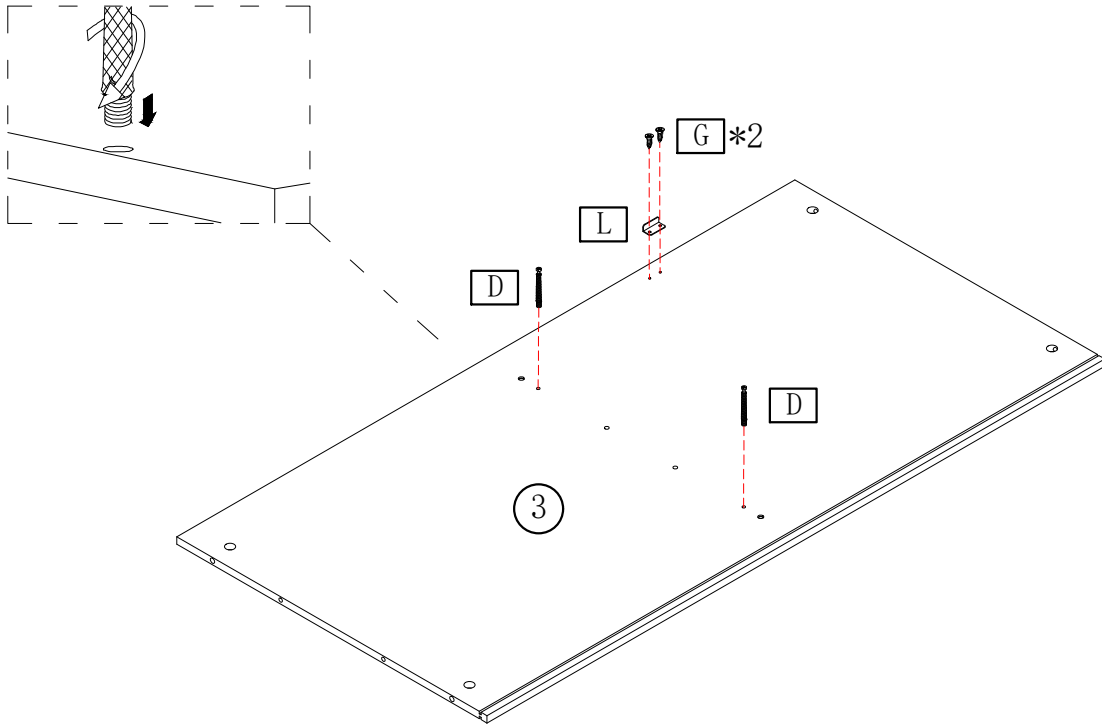

## STEP 3

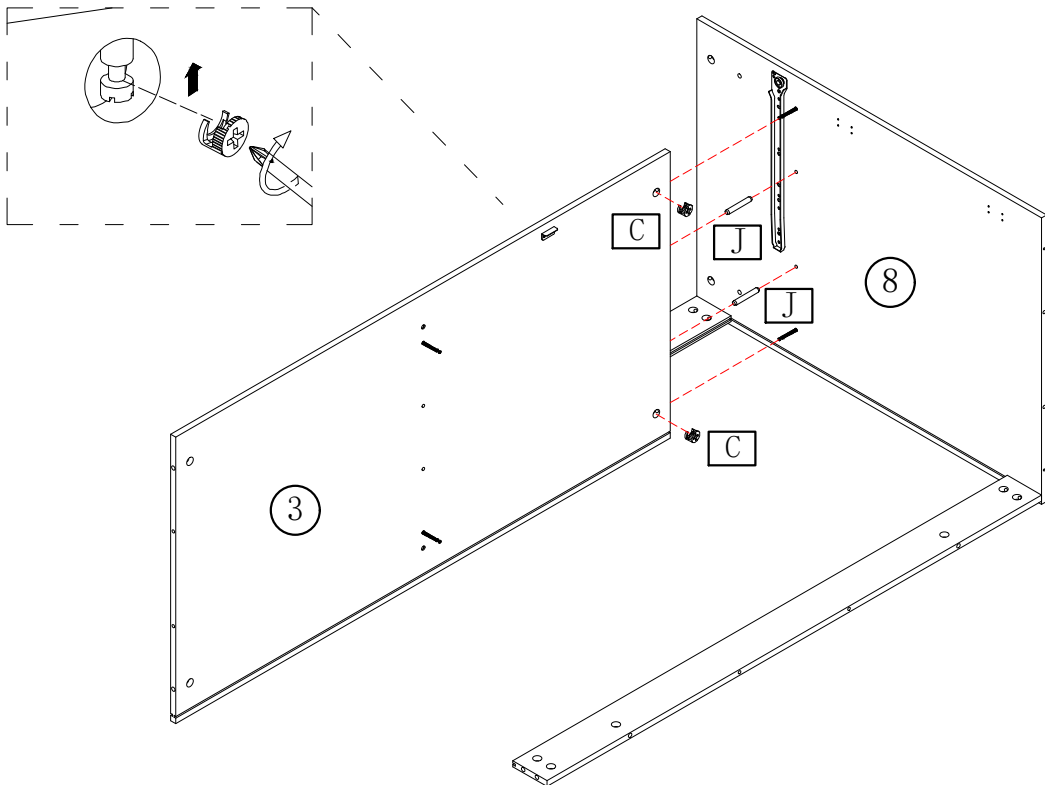

<b>D</b> KM6*40  *2	<b>G</b> M3.5*12  *2	<b>L</b>  *1
---	---	---

## STEP 4



<b>C</b> M15*9  *2	<b>J</b> 6*50mm  *2
---	--

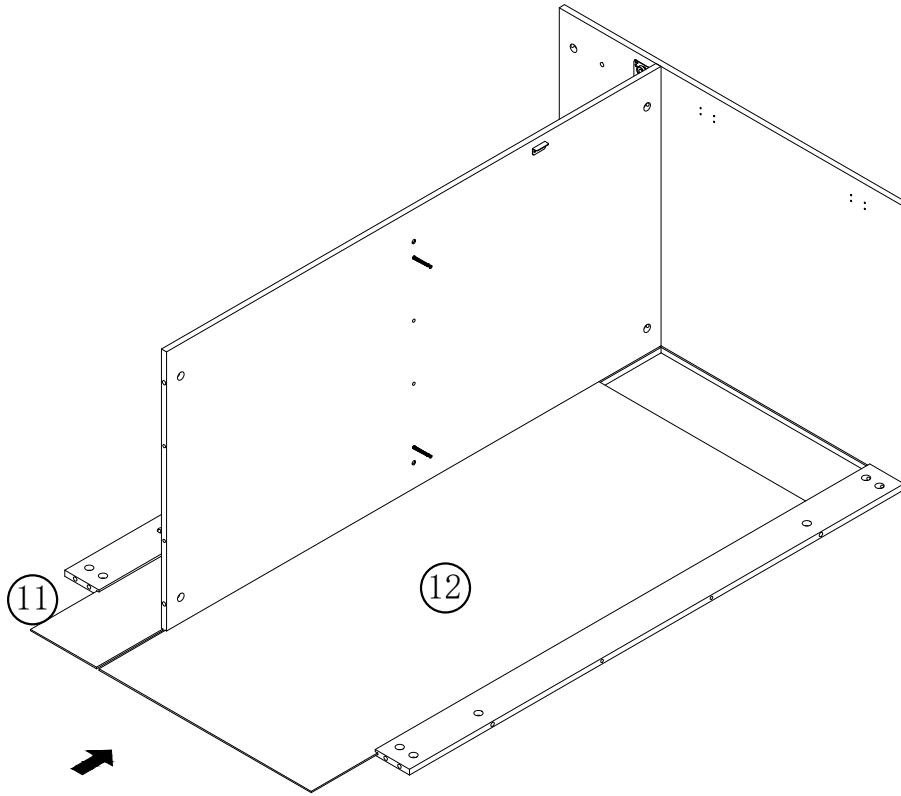

# ASSEMBLY INSTRUCTION

## STEP 5

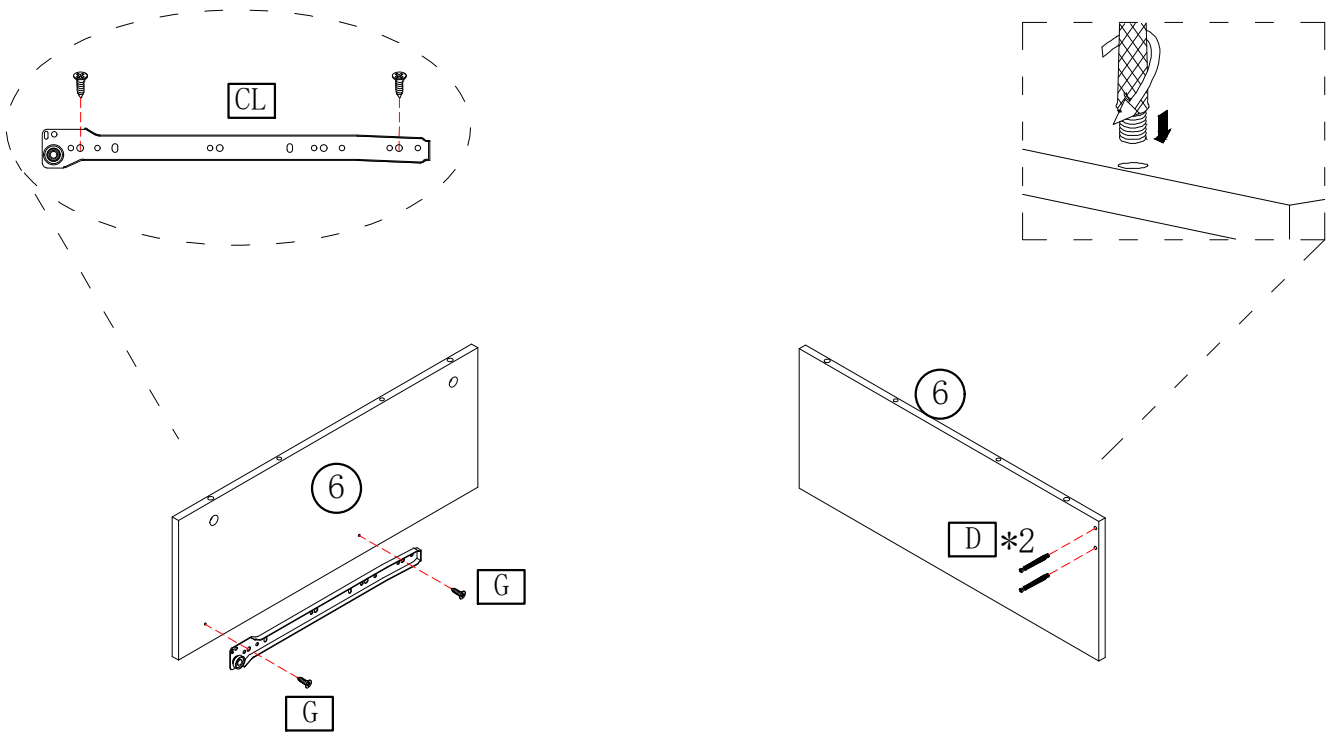

## STEP 6





<b>D</b> KM6*40  *2	<b>G</b> M3.5*12  *2	<b>K</b>  CL *1
---	---	---

# ASSEMBLY INSTRUCTION

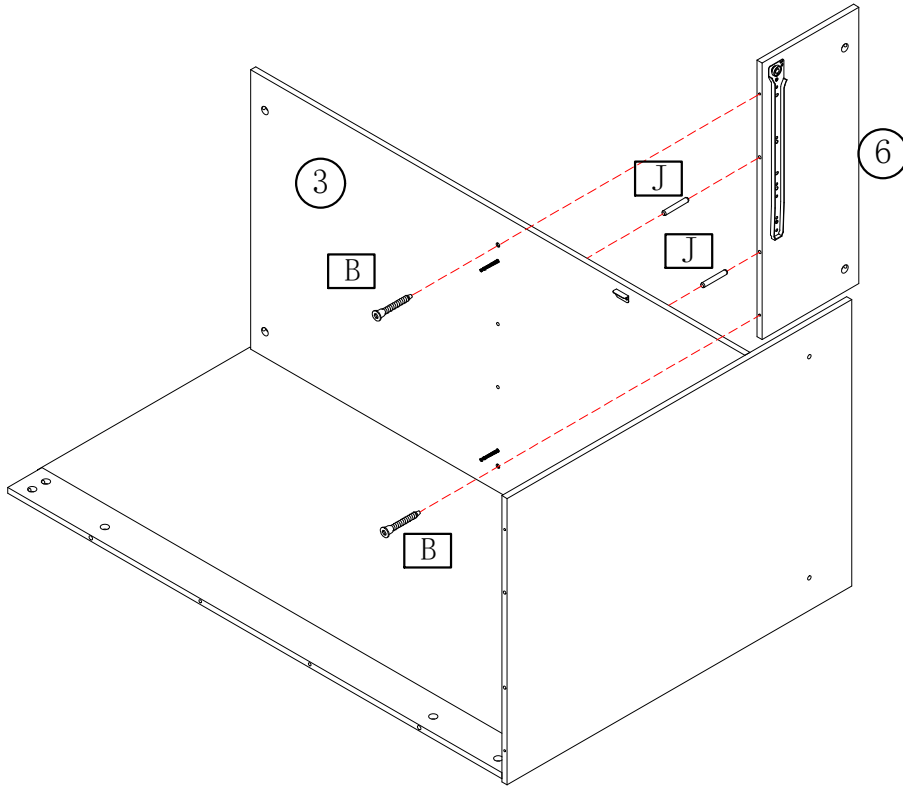

## STEP 7

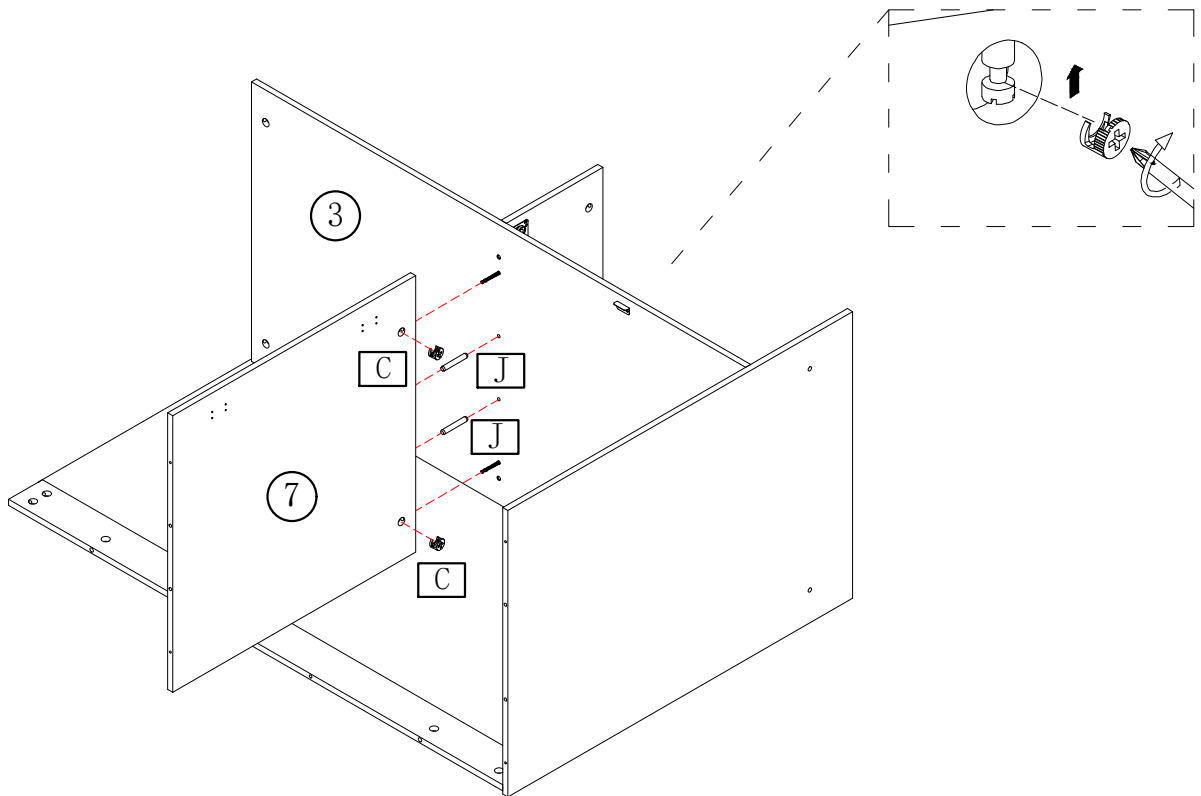

<b>B</b>	M5*40	<b>J</b>	6*50mm
			
	*2		*2

## STEP 8



<b>C</b>	M15*9	<b>J</b>	6*50mm
			
	*2		*2

# ASSEMBLY INSTRUCTION

## STEP 9

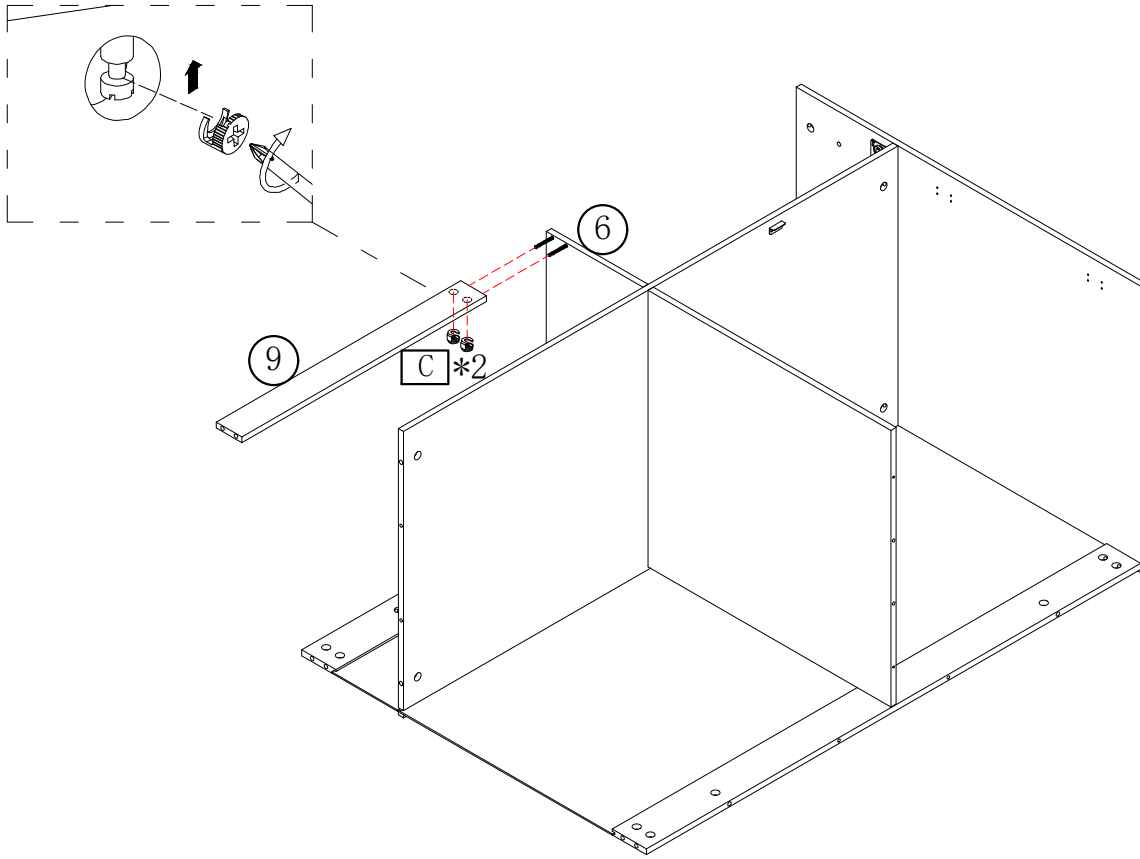

C M15\*9



\*2

## STEP 10

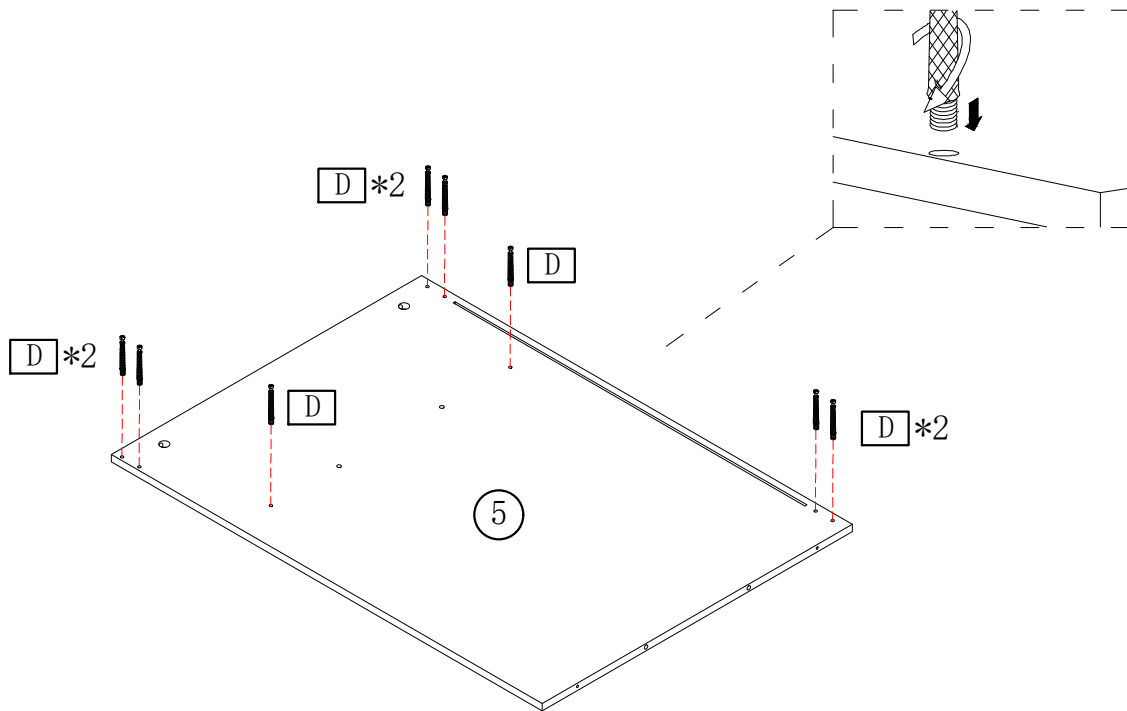

D KM6\*40





\*8

# ASSEMBLY INSTRUCTION

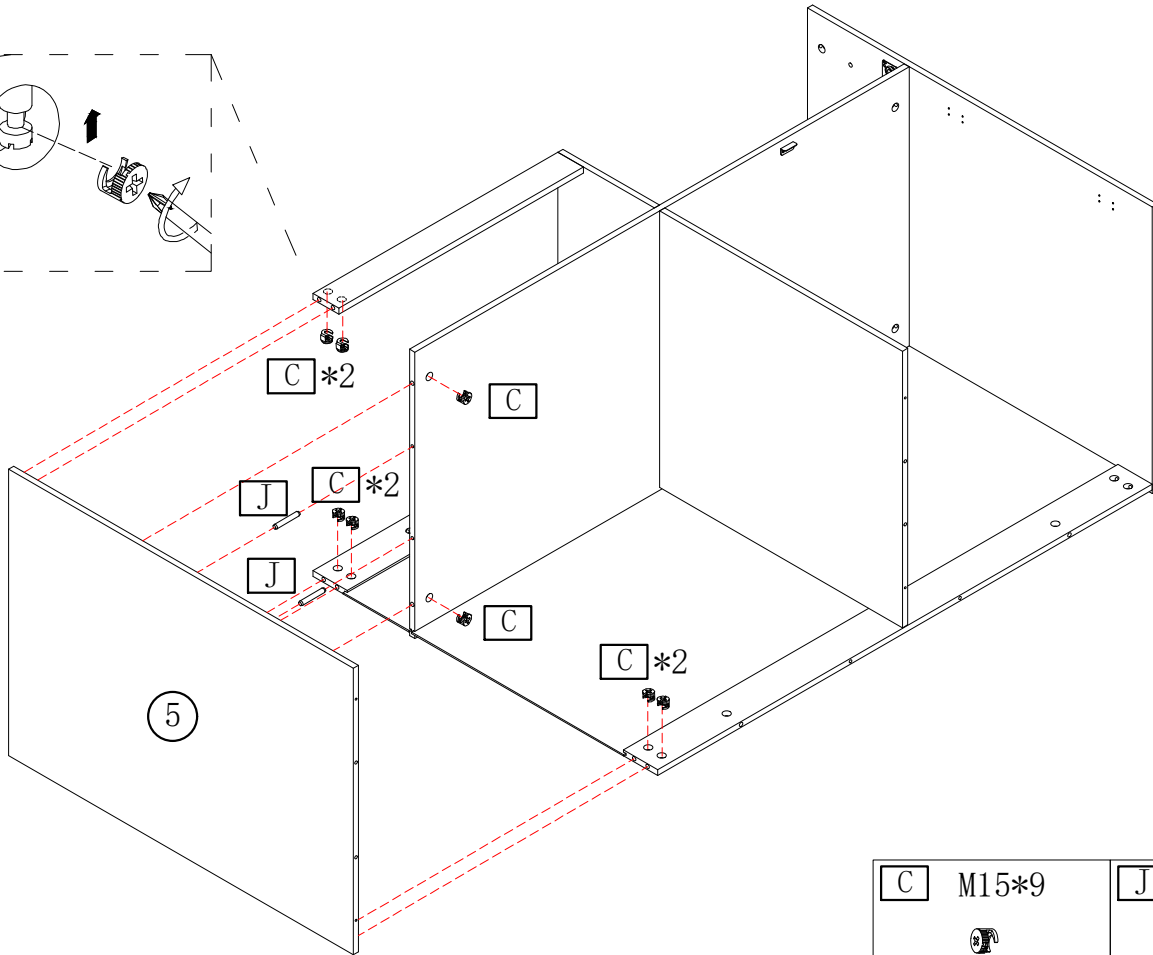
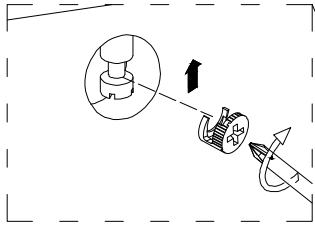
## STEP 11



<b>C</b> M15*9	<b>J</b> 6*50mm
 *8	 *2

## STEP 12

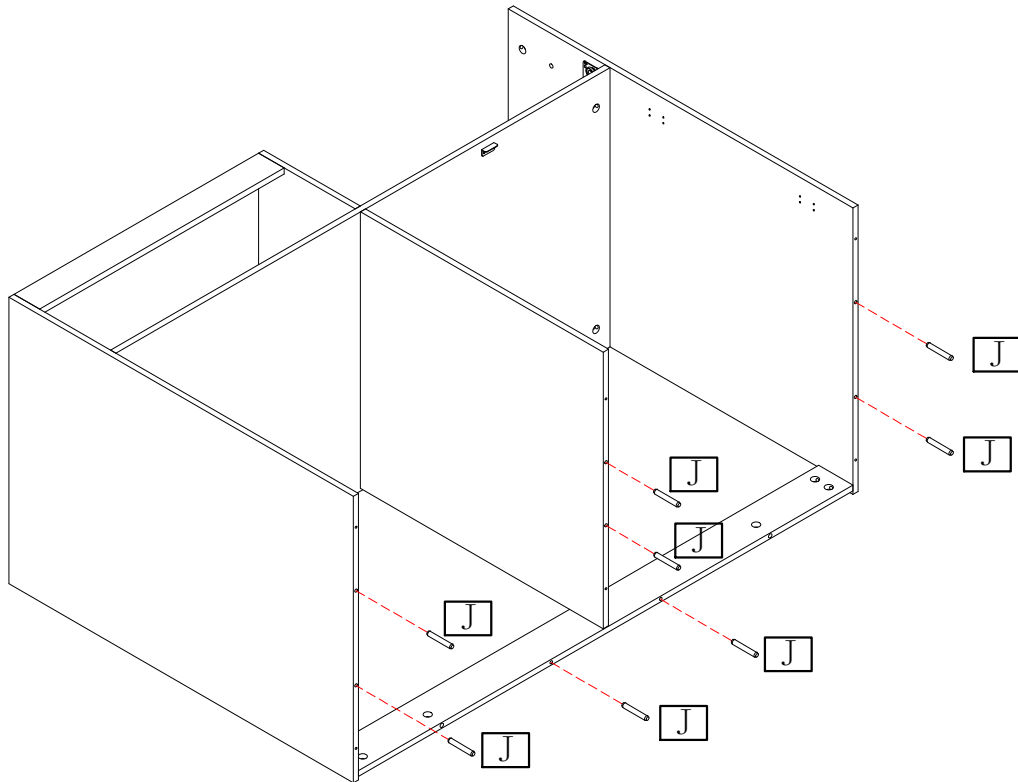

<b>J</b> 6*50mm
 *8

# ASSEMBLY INSTRUCTION

## STEP 13

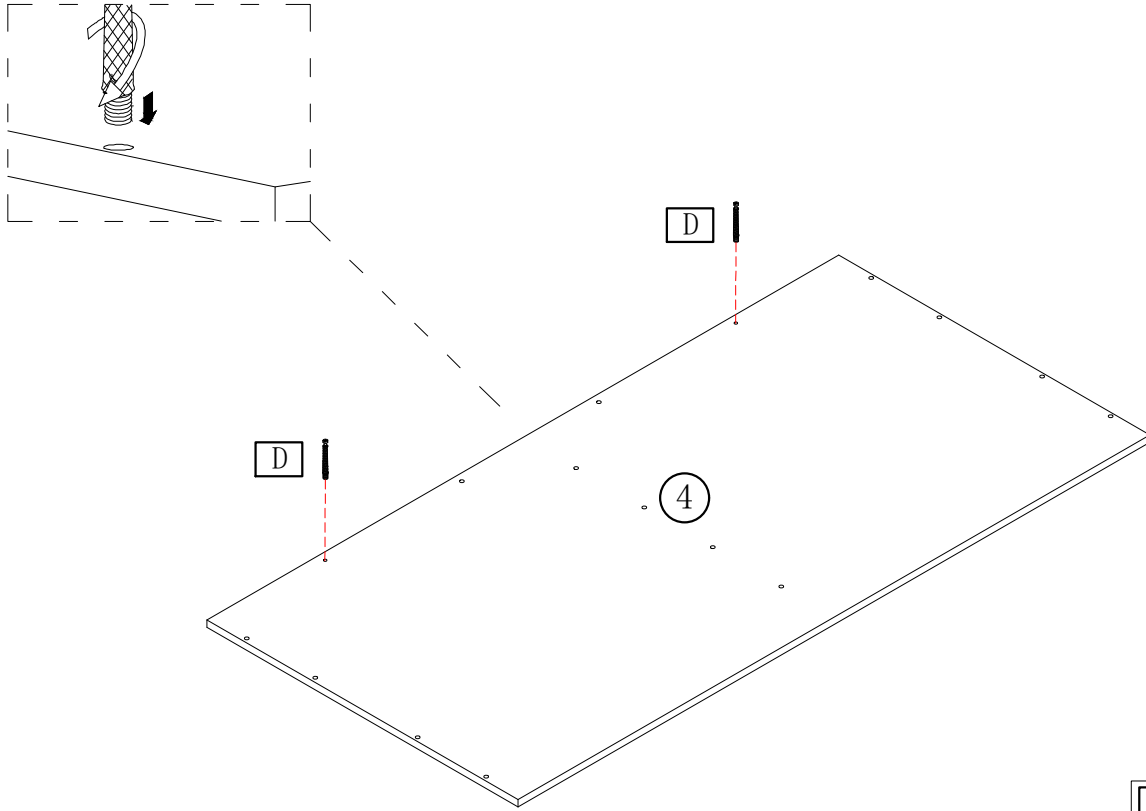

D KM6\*40



\*2

## STEP 14

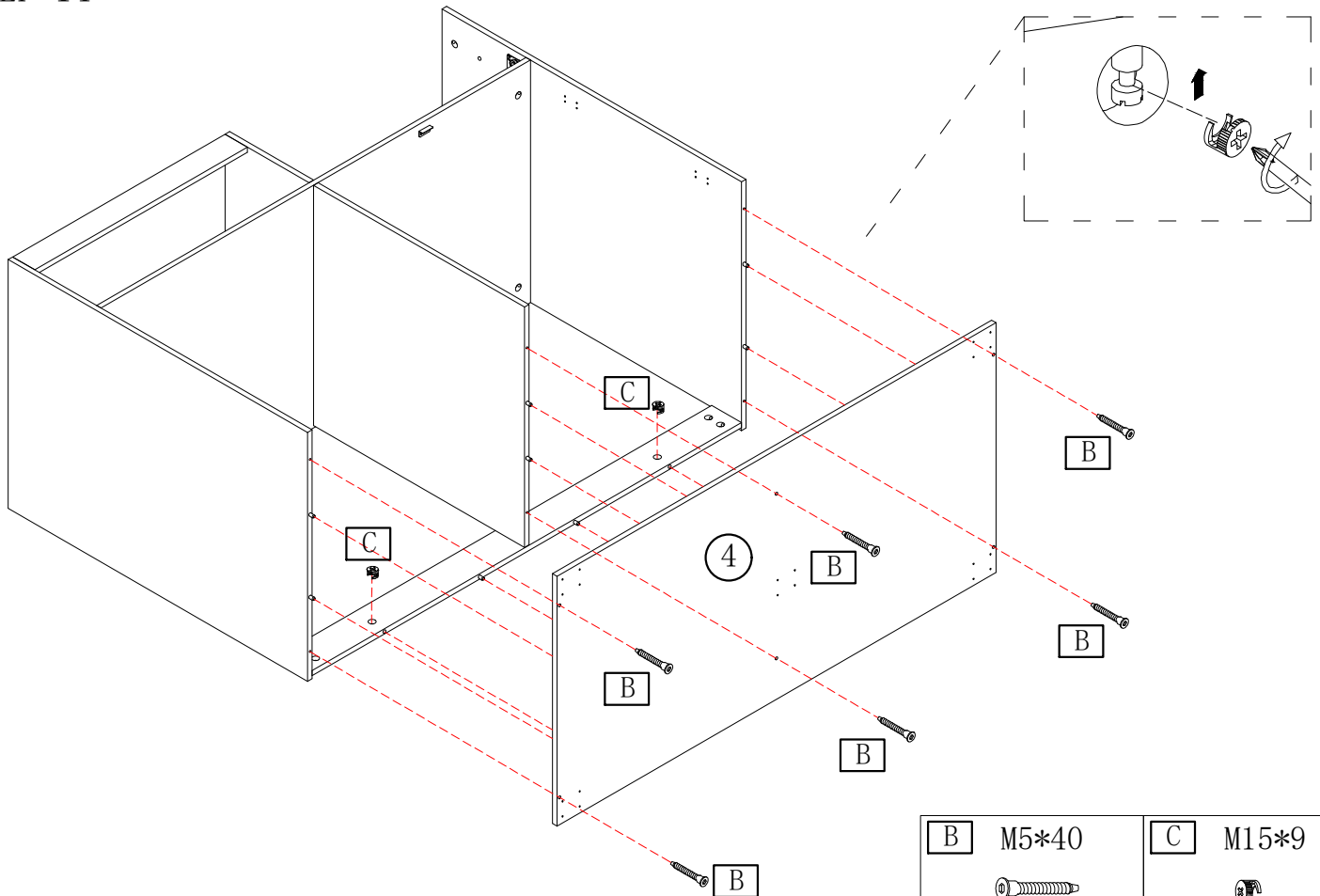

B M5\*40

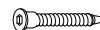

\*6

C M15\*9





\*2

# ASSEMBLY INSTRUCTION

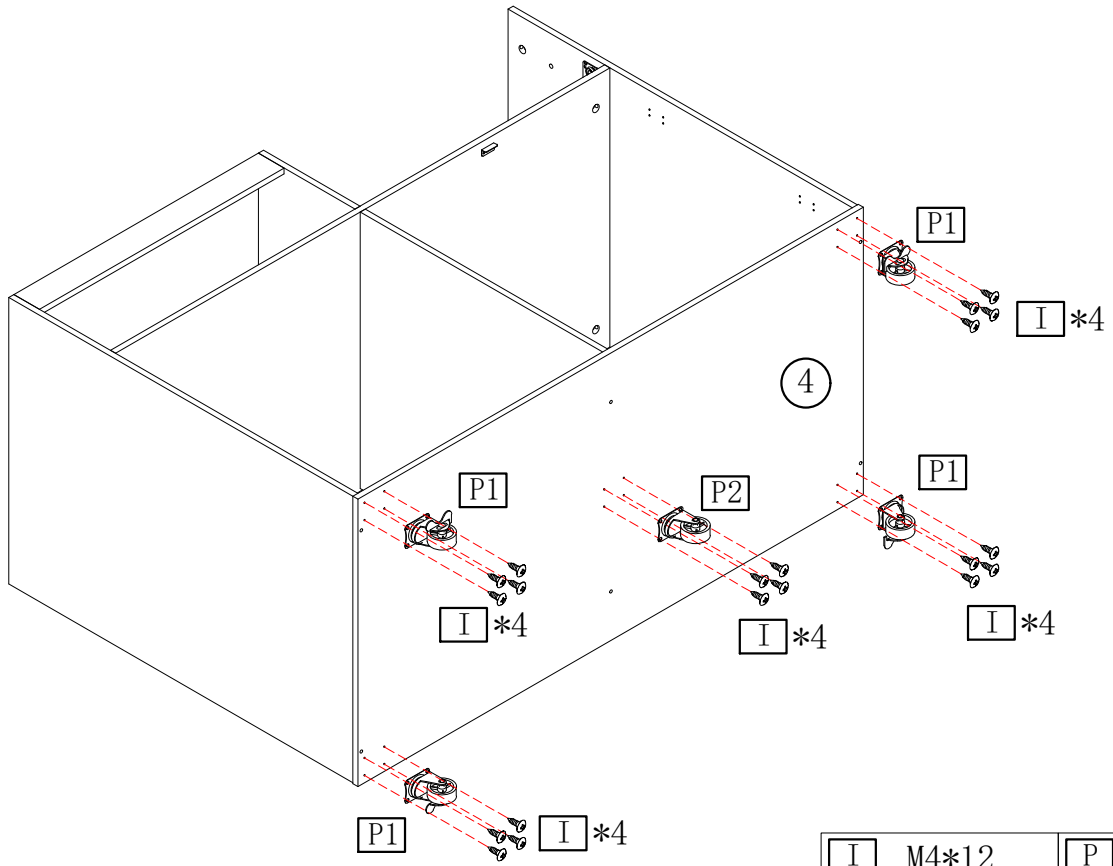

STEP 15

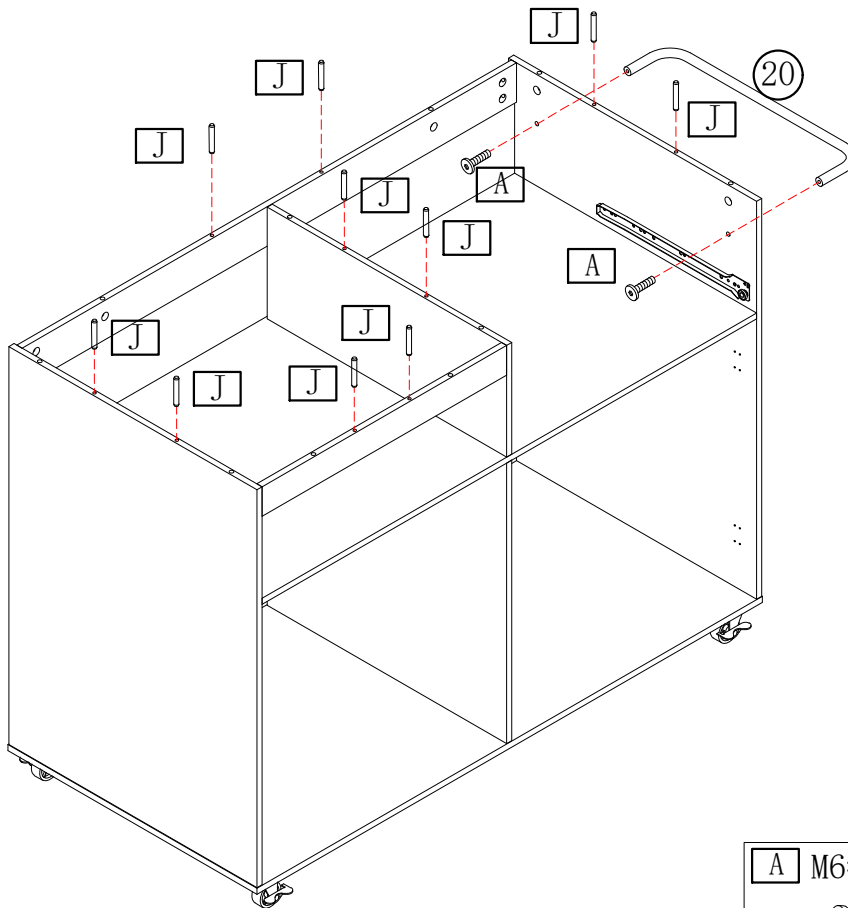

<b>I</b> M4*12  *20	<b>P</b>  P1*4  P2*1
---	--

STEP 16





<b>A</b> M6*30mm  *2	<b>J</b> 6*50mm  *10
--	--

# ASSEMBLY INSTRUCTION

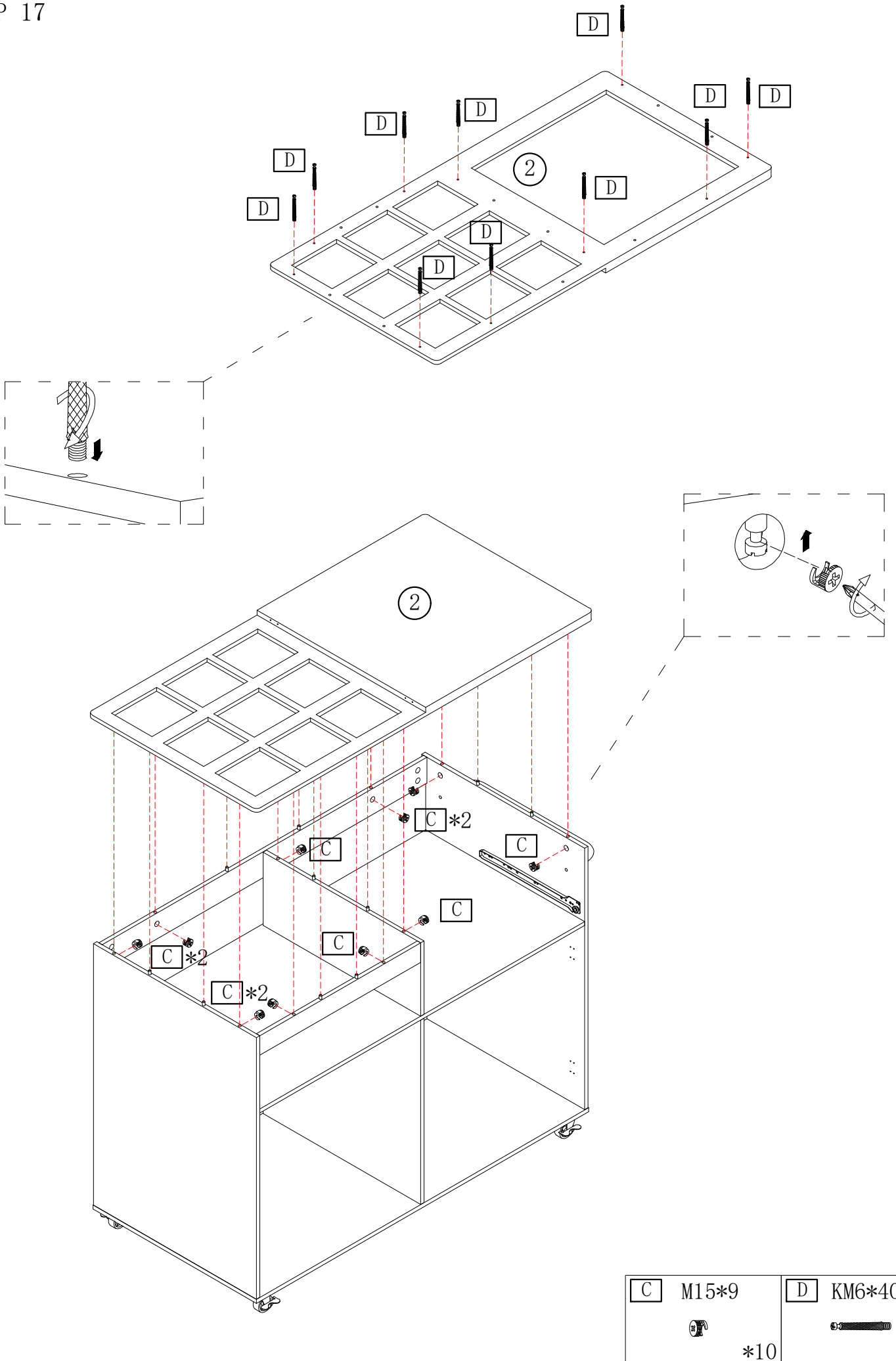
STEP 17



<b>C</b>	M15*9	<b>D</b>	KM6*40
			
	*10		*10

# ASSEMBLY INSTRUCTION

STEP 18

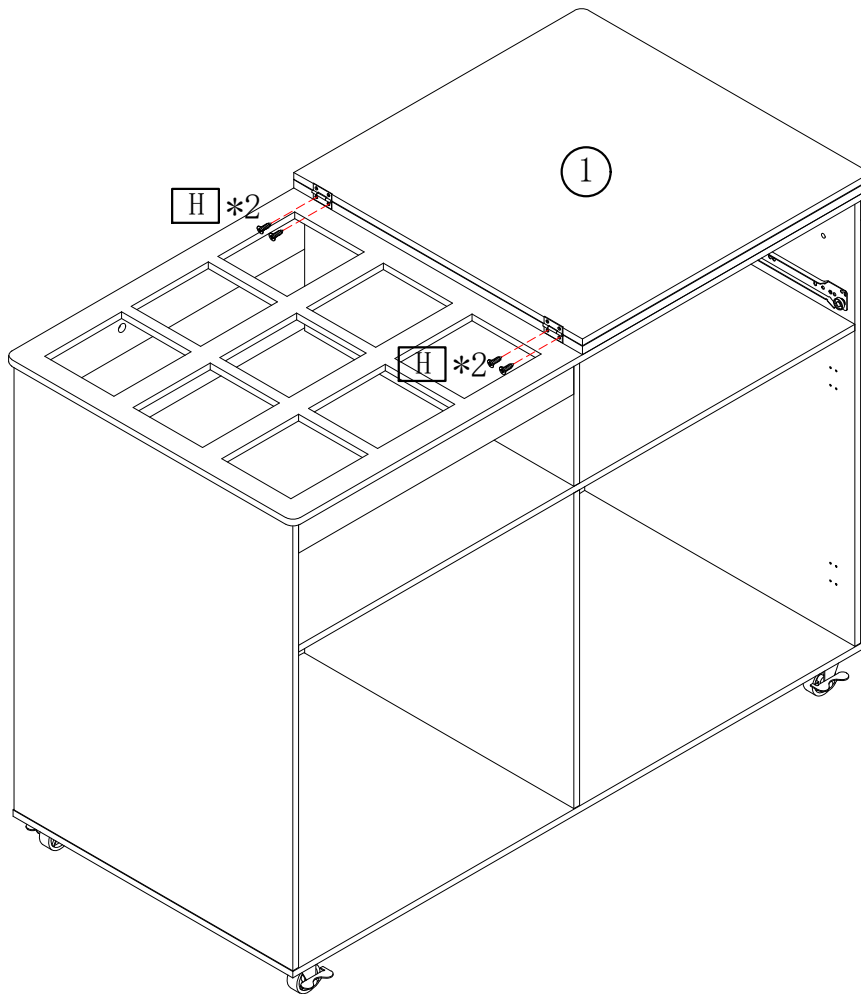
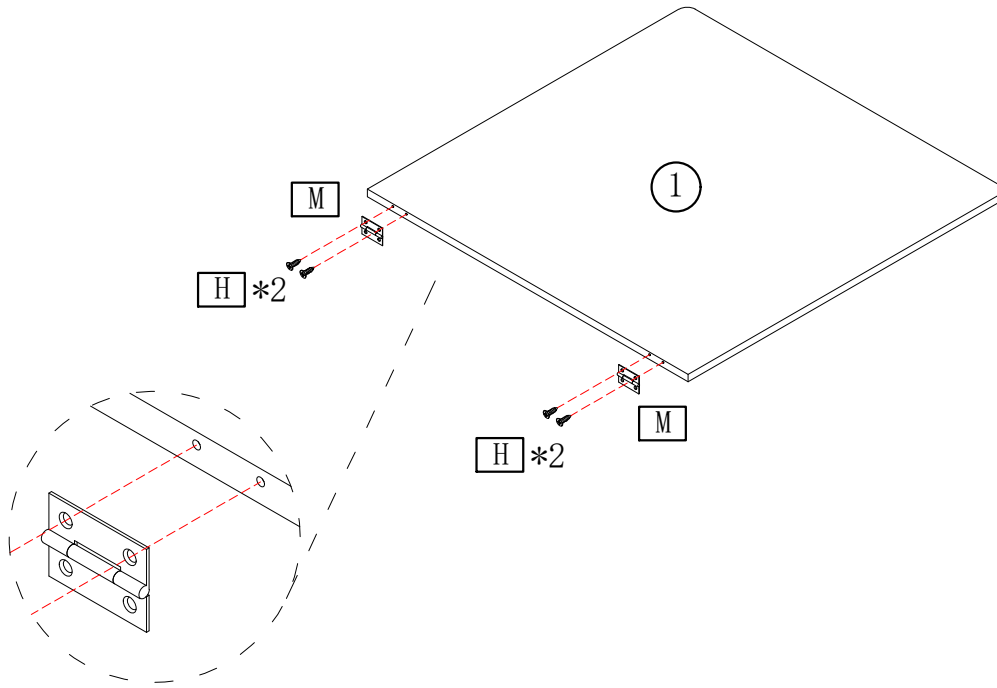

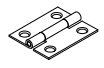

<b>H</b>	M3*12	<b>M</b>
		
	*8	*2

# ASSEMBLY INSTRUCTION

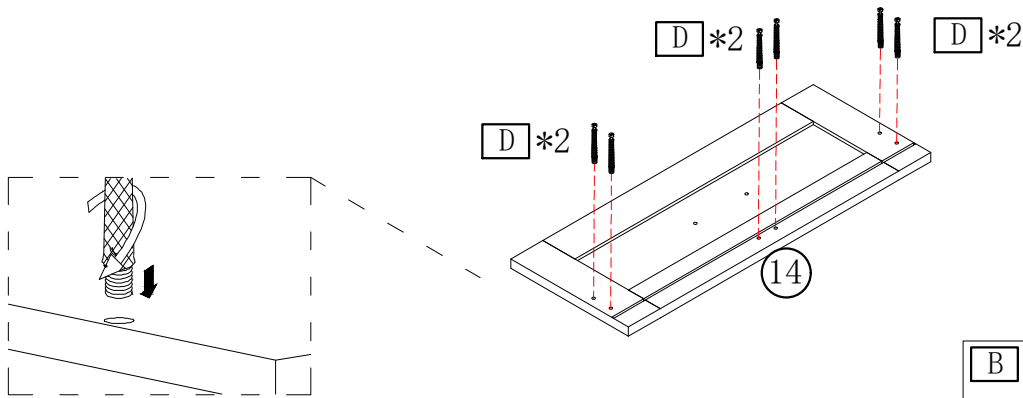
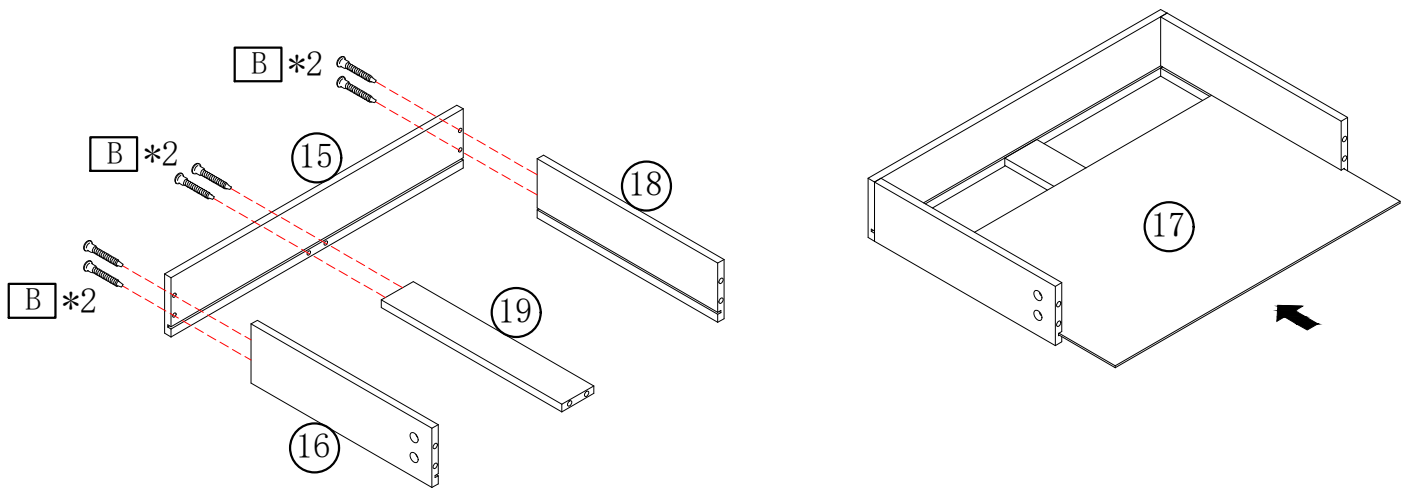

## STEP 19

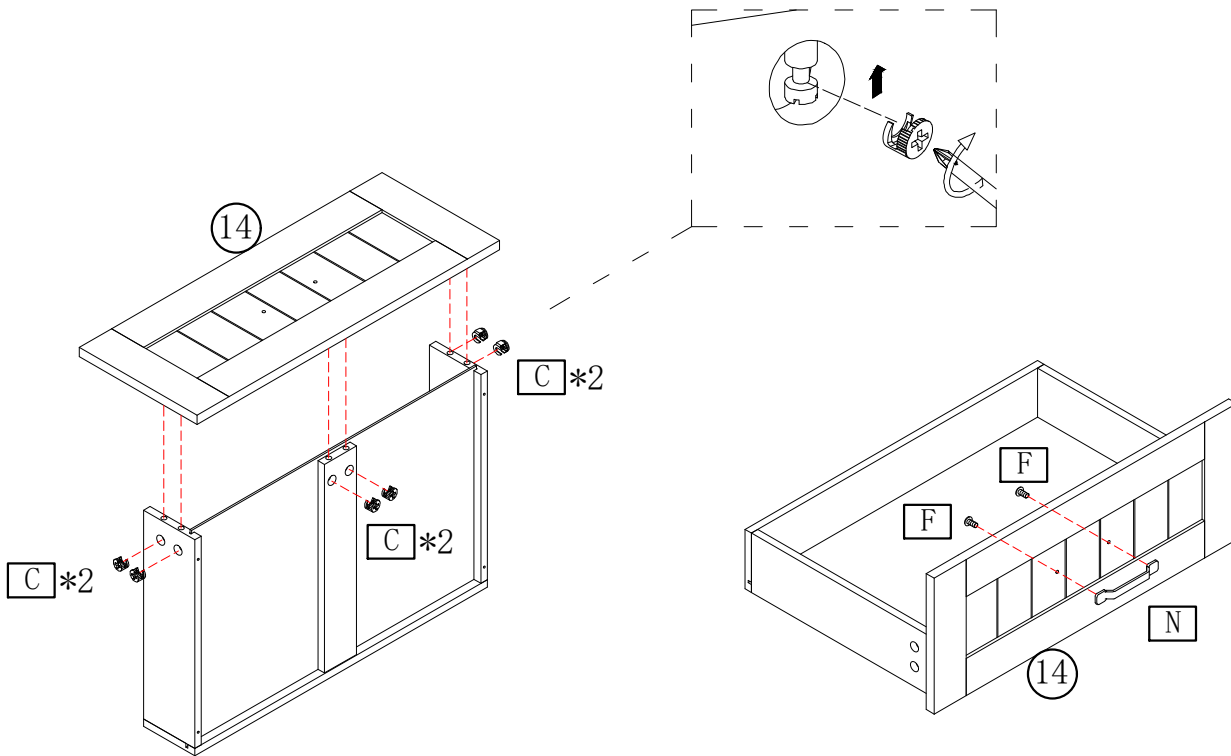

<b>B</b>	M5*40	<b>D</b>	KM6*40
			
*6		*6	

## STEP 20





<b>C</b>	M15*9	<b>F</b>	M4*8	<b>N</b>	
					
*6		*2		*1	

# ASSEMBLY INSTRUCTION

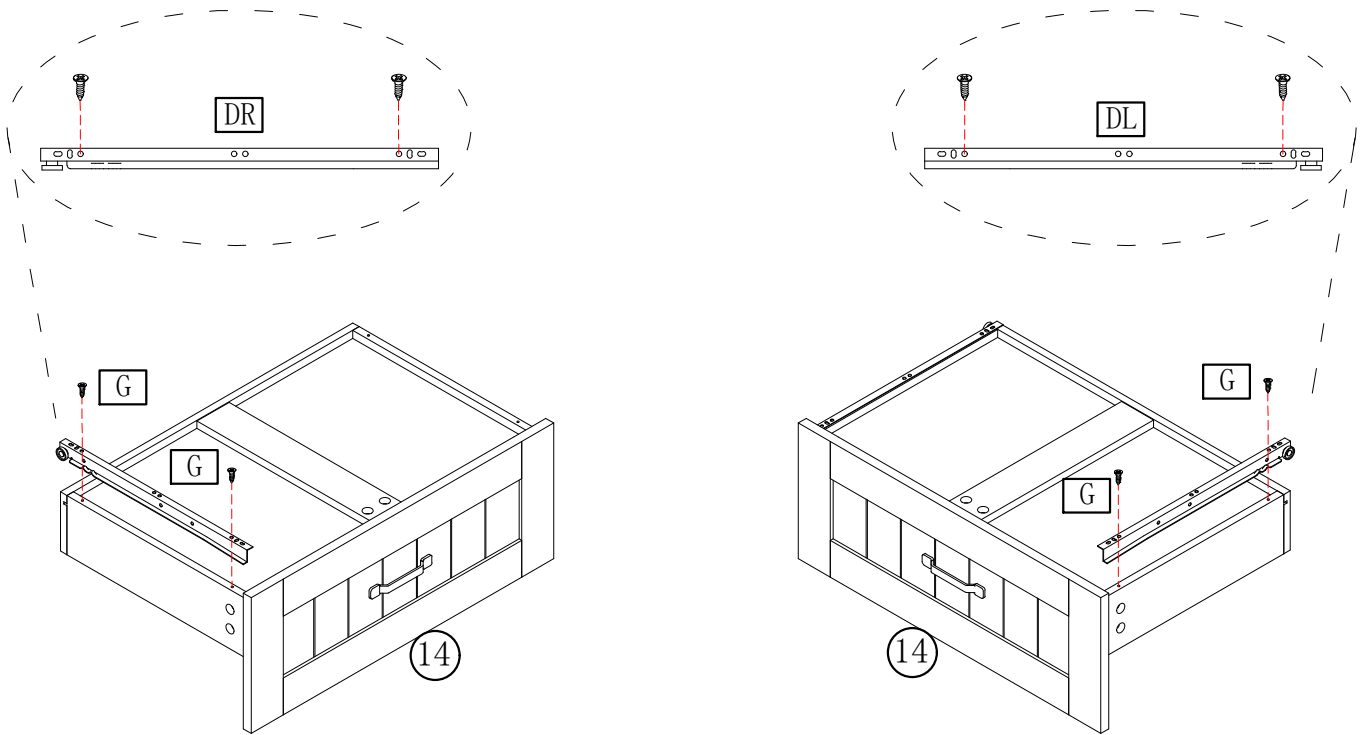
## STEP 21





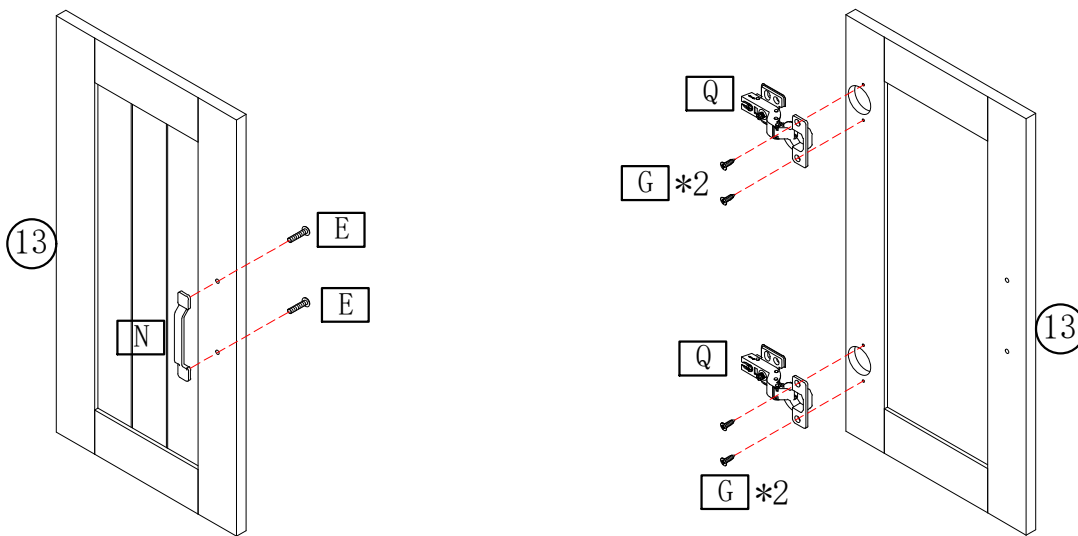

<b>G</b> M3.5*12  *4	<b>K</b>  DL DR *1
---	---

## STEP 22

**X2**

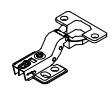

<b>E</b> M4*18  *4	<b>G</b> M3.5*12  *8	<b>Q</b>  *4	<b>N</b>  *2
---	---	---	---

# ASSEMBLY INSTRUCTION

## STEP 23

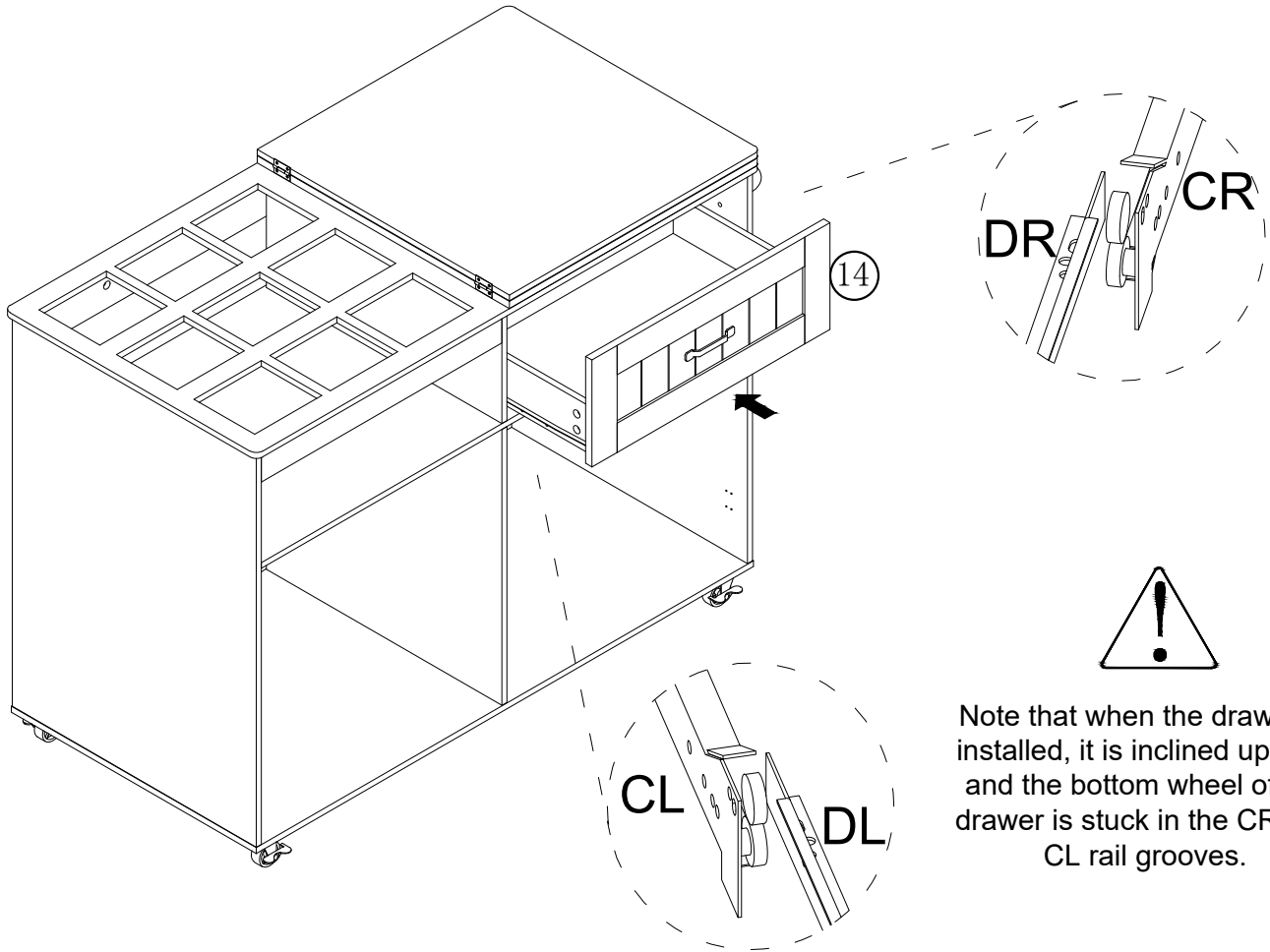

Note that when the drawer is installed, it is inclined upward and the bottom wheel of the drawer is stuck in the CR and CL rail grooves.

## STEP 24

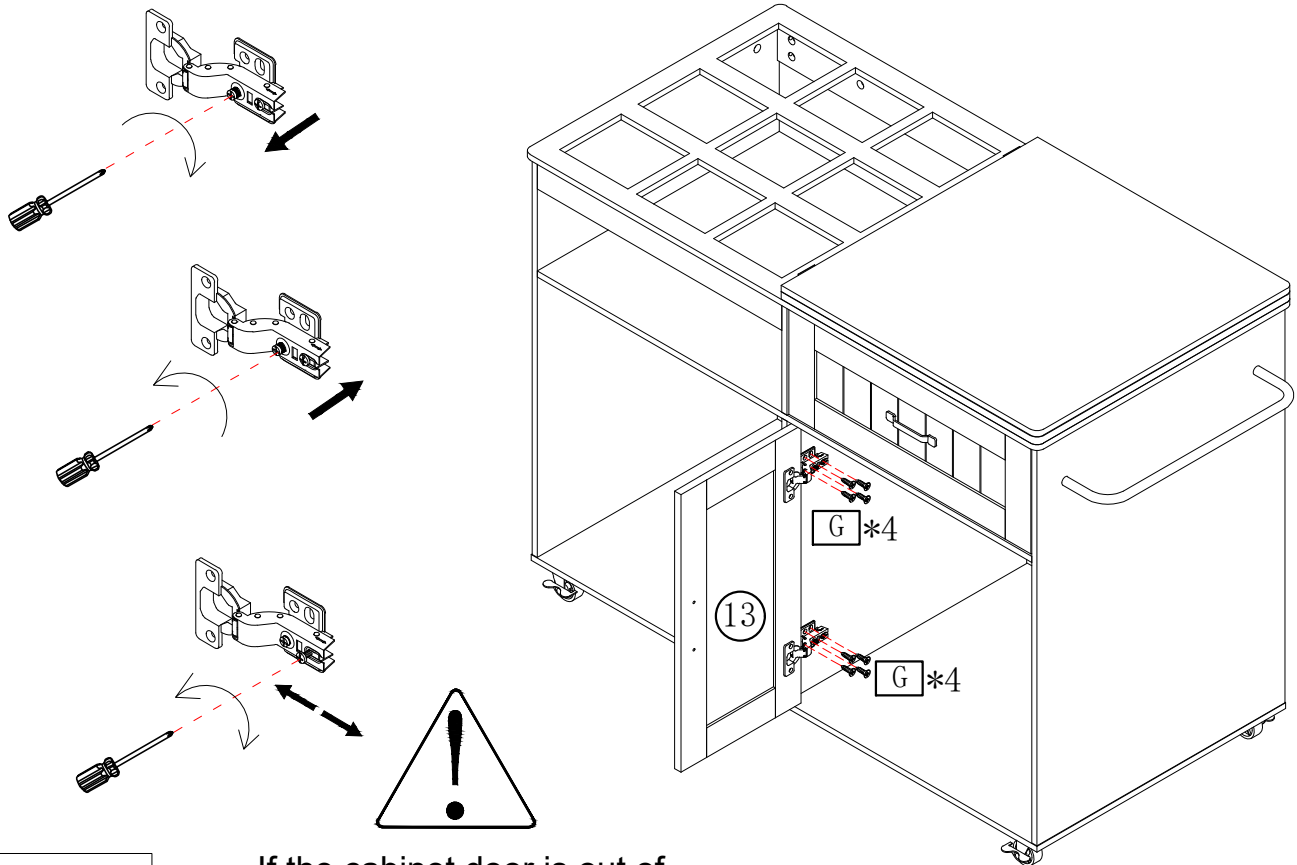

If the cabinet door is out of balance, you can adjust the hinge

G M3. 5\*12



\*8

# ASSEMBLY INSTRUCTION

STEP 25

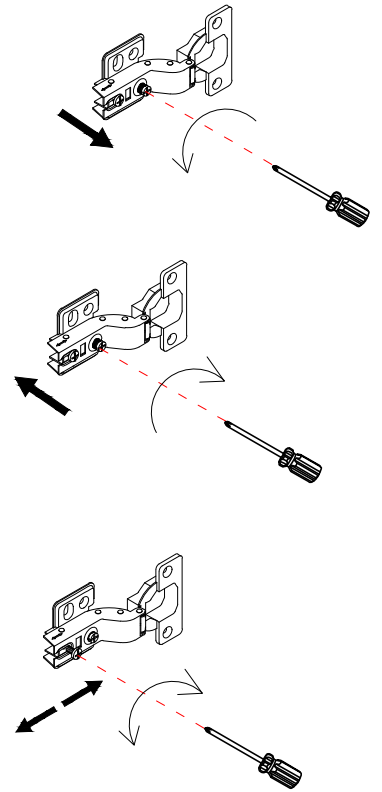
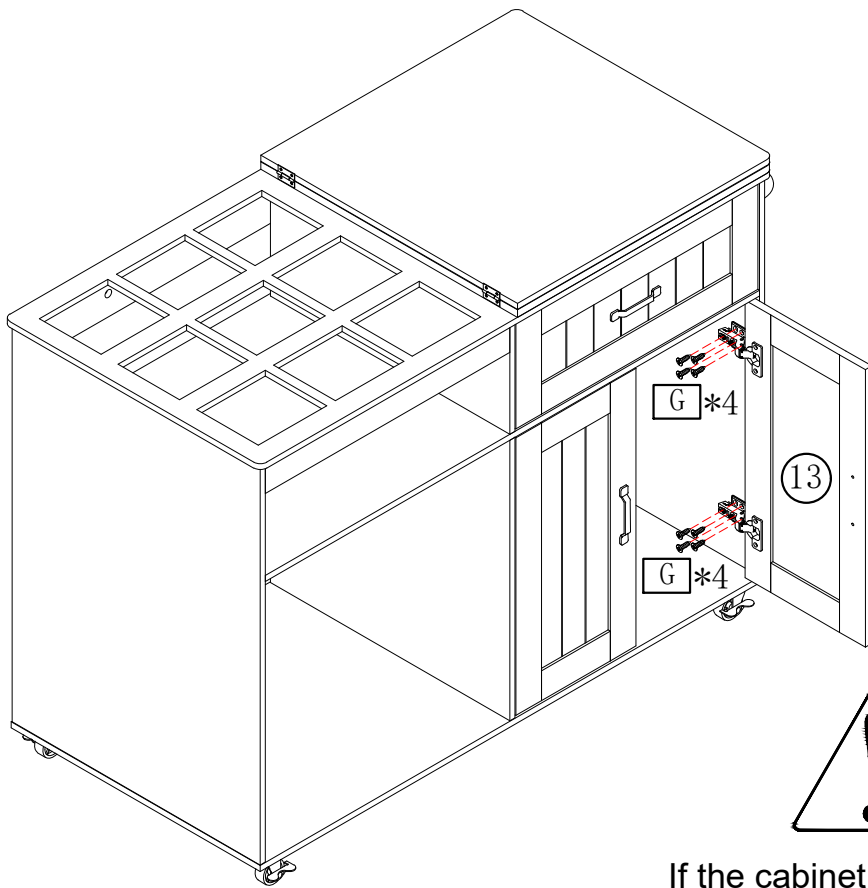

If the cabinet door is out of balance, you can adjust the hinge

G M3.5\*12



\*8

STEP 26

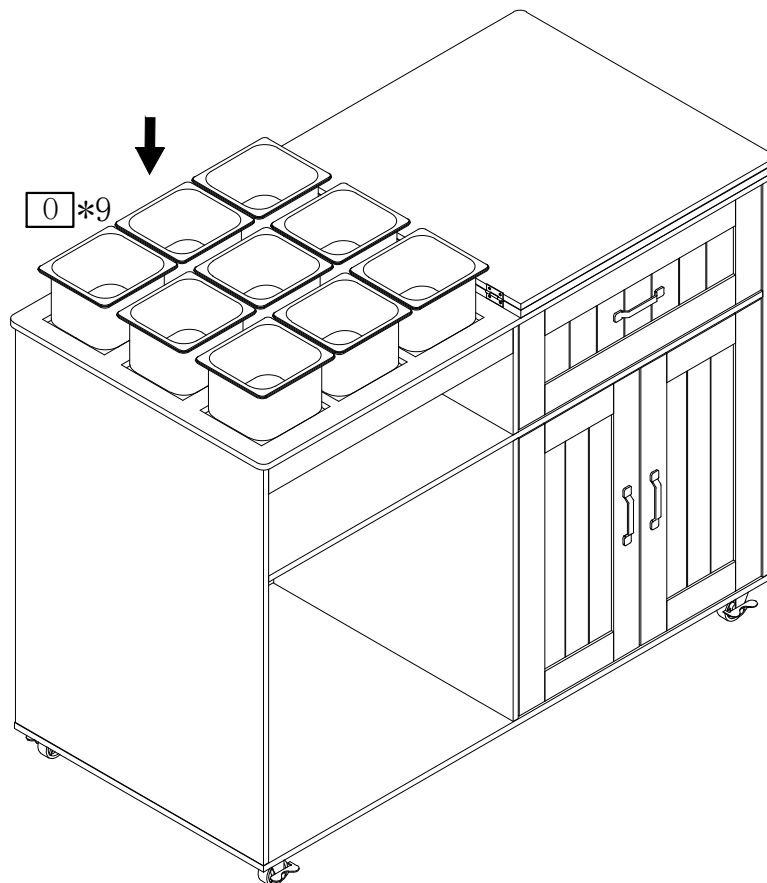

0

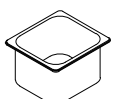

\*9