

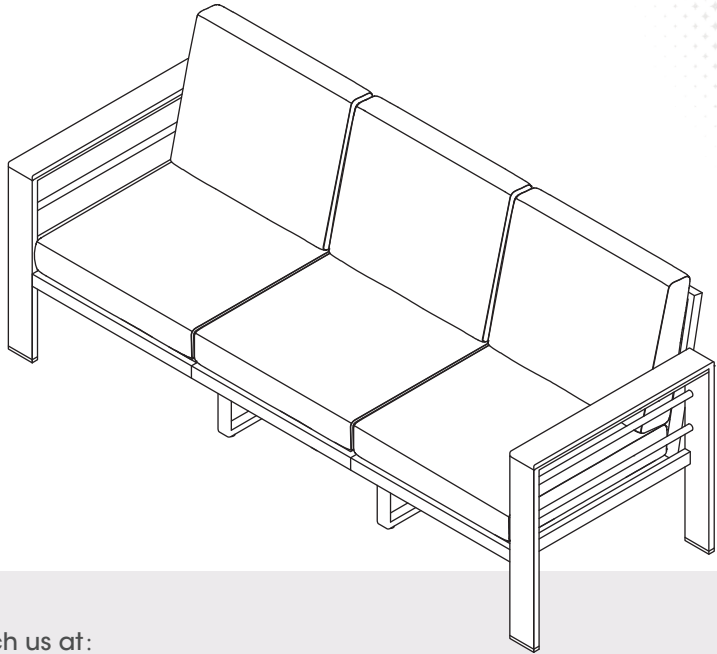

MANUAL INSTRUCTION

Aluminum three-seat sofa
G13001LG01C-ML



Reach us at:

 service@kmcglobe-us.com

 (only us) +1 213-816-4788

We offer a diverse range of products to
meet the needs of customers.

PARTS

A Right Armrest

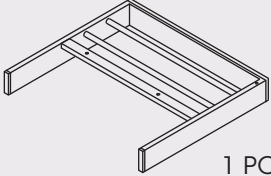

1 PC

The diagram shows a right armrest component, which is a rectangular frame with a flat top surface and a vertical backrest section.

B Left Armrest

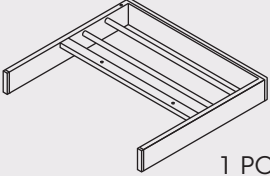

1 PC

The diagram shows a left armrest component, which is a rectangular frame with a flat top surface and a vertical backrest section, mirroring the right armrest.

C Seat plate

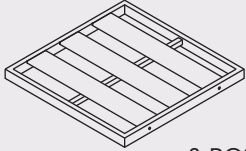

3 PCS

The diagram shows three seat plate components, which are rectangular frames with a flat top surface and a vertical backrest section.

D Back plate

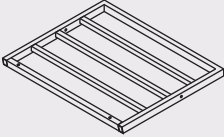

3 PCS

The diagram shows three back plate components, which are rectangular frames with a flat top surface and a vertical backrest section.

E Seat cushion

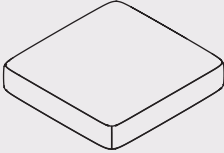

3 PCS

The diagram shows three seat cushion components, which are rectangular blocks with a flat top surface and a vertical backrest section.

F Back cushion

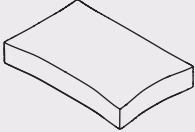

3 PCS

The diagram shows three back cushion components, which are rectangular blocks with a flat top surface and a vertical backrest section.

G Middle leg

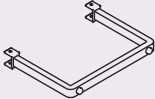

2 PCS



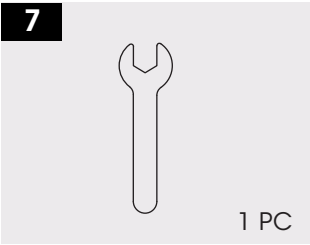
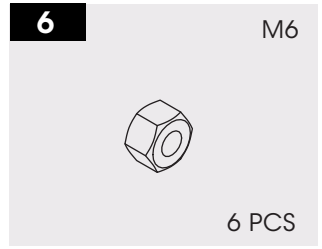
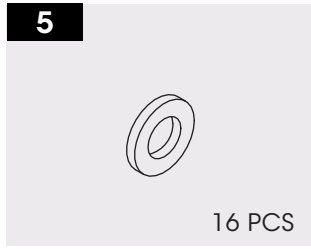
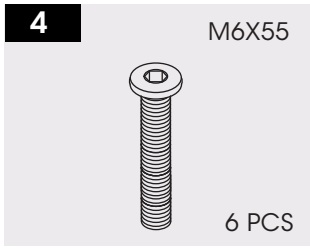
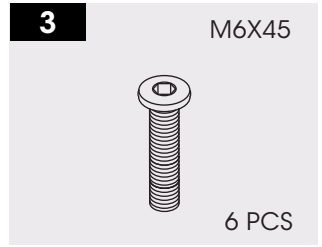
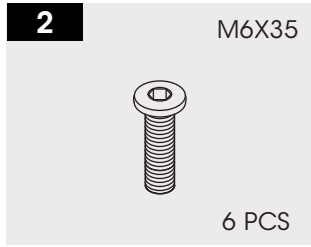
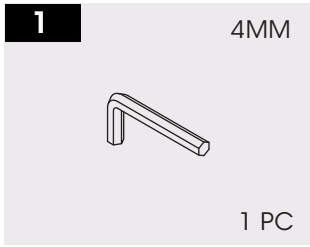

The diagram shows two middle leg components, which are L-shaped brackets with a flat top surface and a vertical backrest section.

HARDWARE





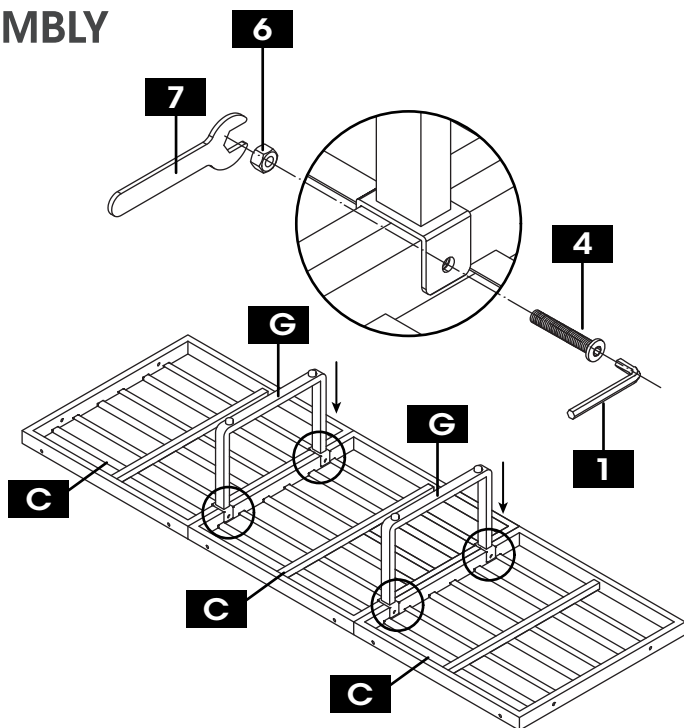

I PRODUCT ASSEMBLY

1 Step 1

PART	NO.	QTY.
	C	3
	G	2
	4	4
	6	4



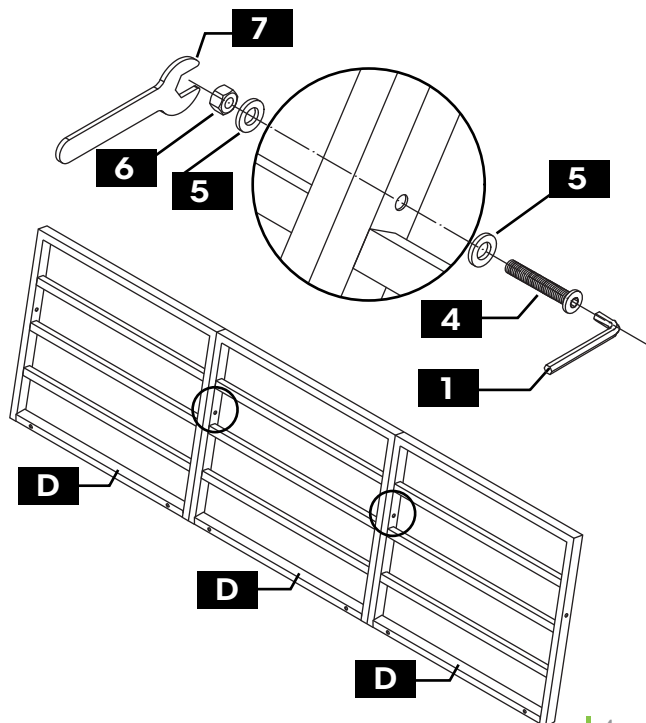

2 Step 2

PART	NO.	QTY.
	D	3
	4	2
	5	4
	6	2





I PRODUCT ASSEMBLY

3 Step 3

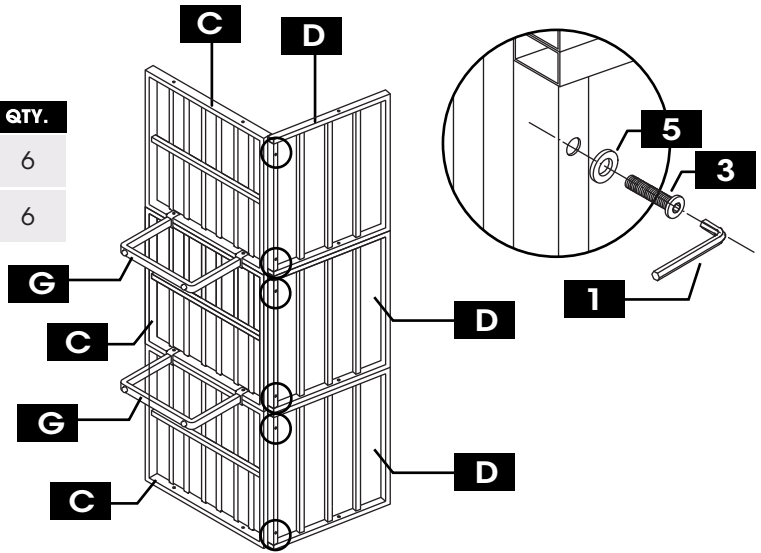
PART	NO.	QTY.
	3	6
	5	6



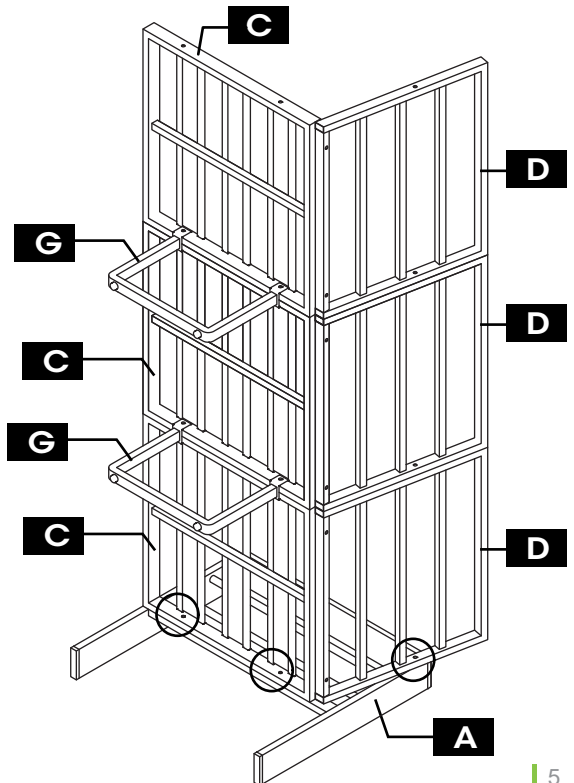
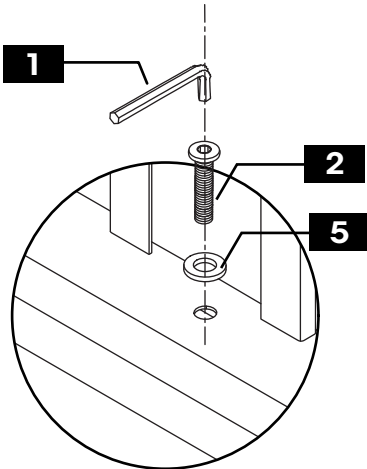

4 Step 4

PART	NO.	QTY.
	A	1
	5	3
	2	3





I PRODUCT ASSEMBLY

5 Step 5

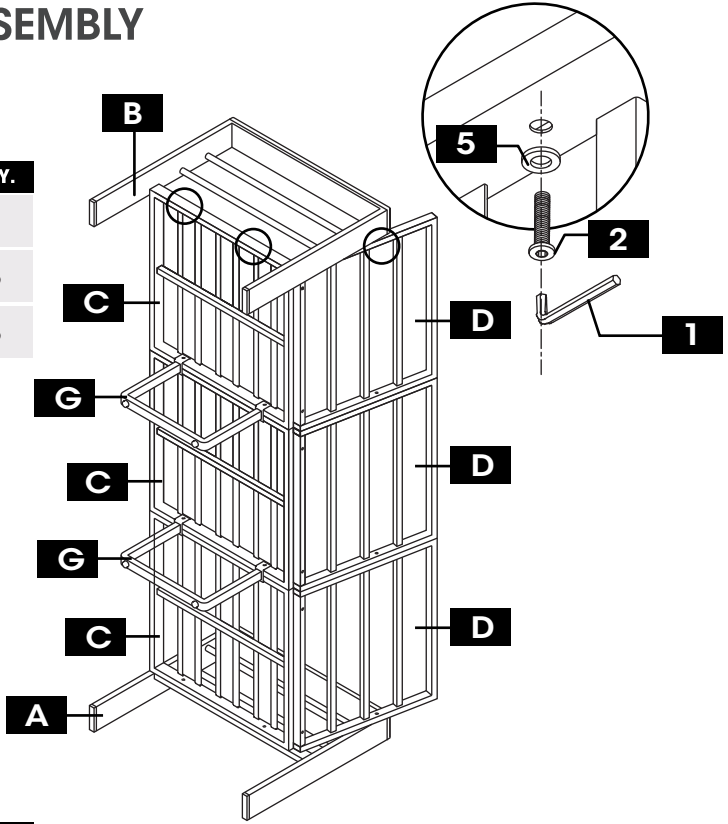
PART	NO.	QTY.
	B	1
	5	3
	2	3



6 Step 6

PART	NO.	QTY.
	F	3
	E	3

