

Assembly Instruction

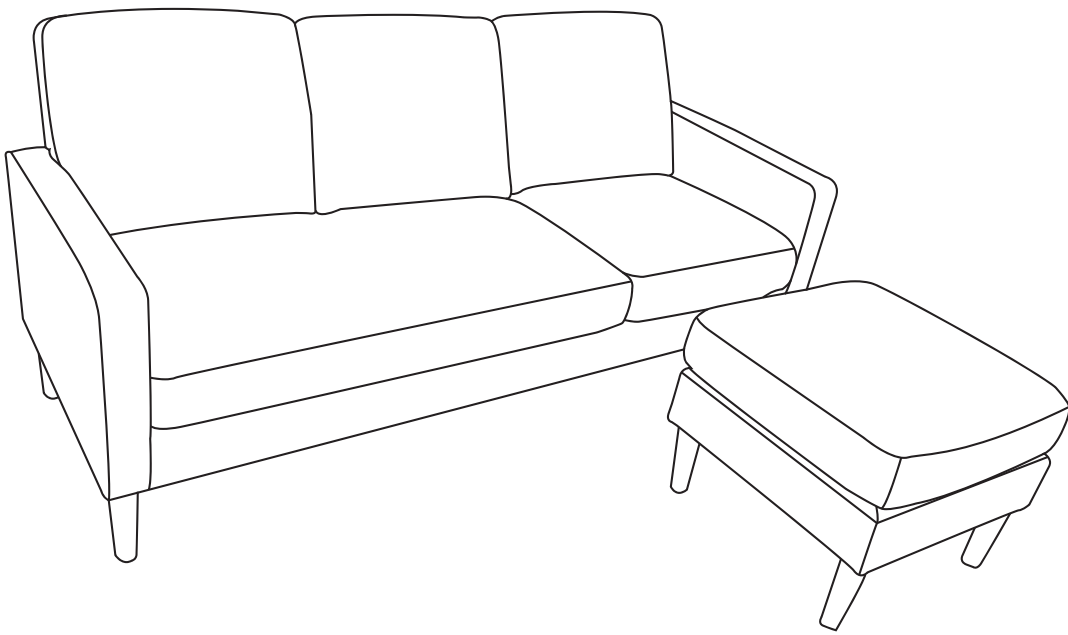

Attention: Do not open the compression bag if you are not satisfied with the product









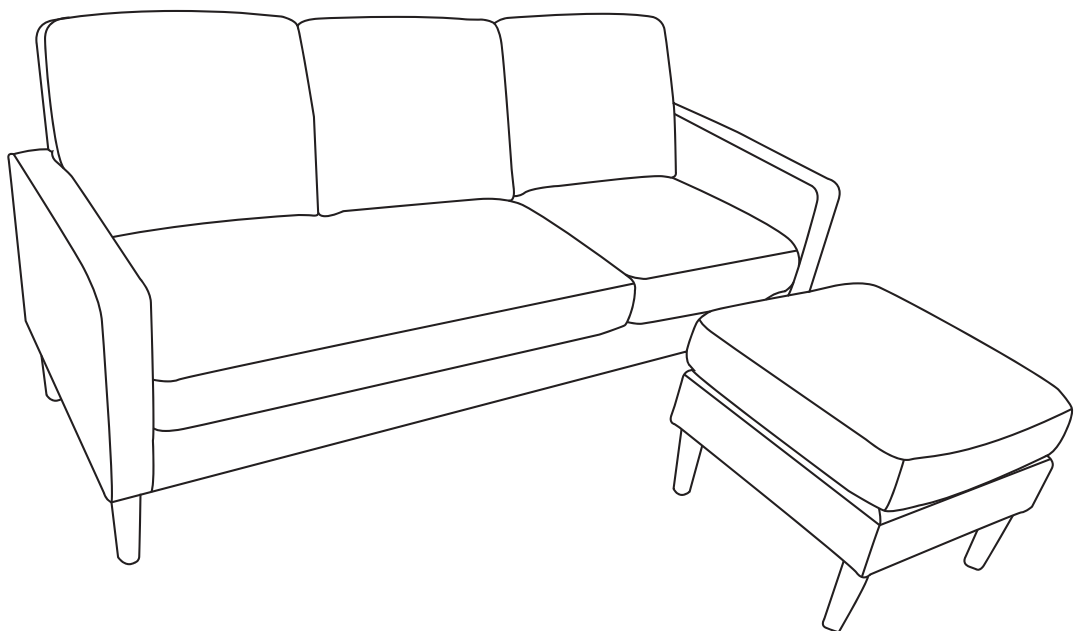
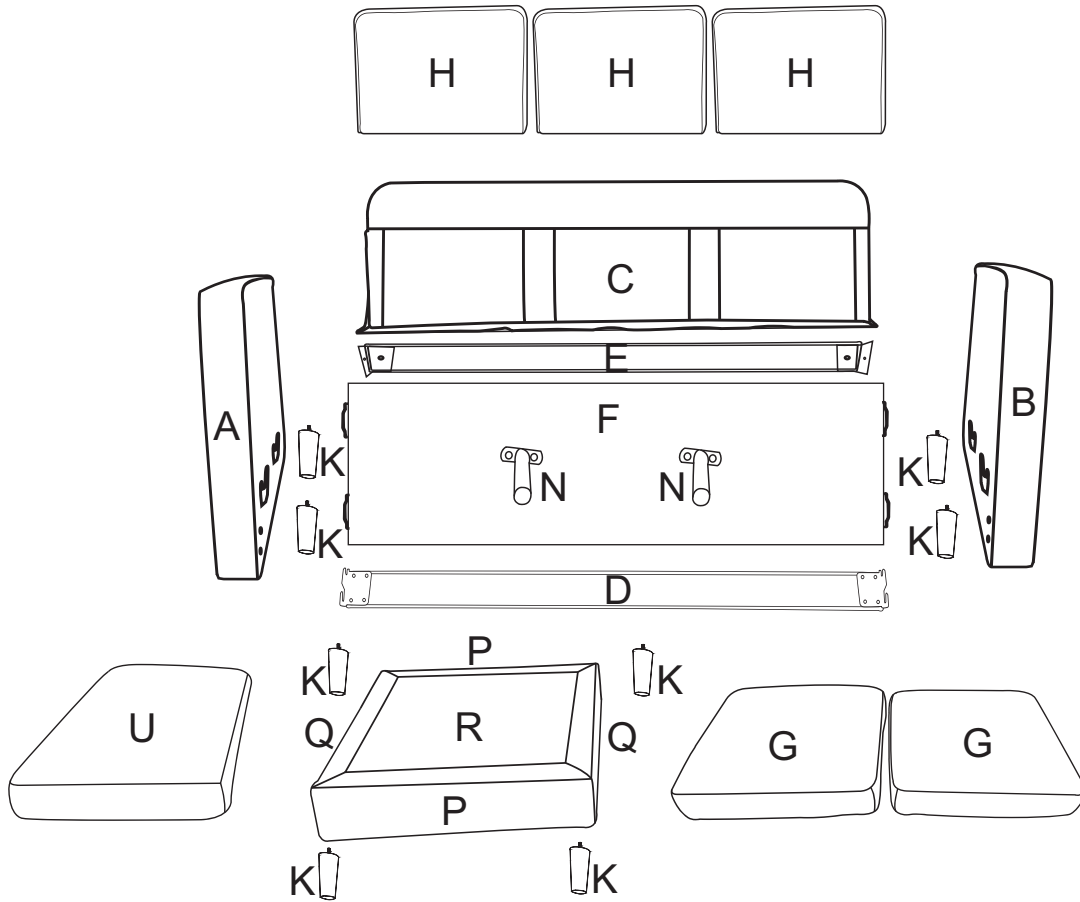

Thank you for your purchase.

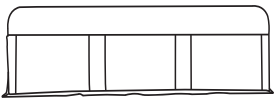



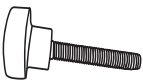

If you have difficulty with assembly or find a part is missing or damaged, please don't hesitate to contact us for solution.

Customer Service team will work hard to put a smile back on your face.

Components

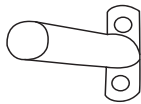
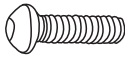

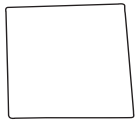
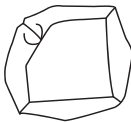
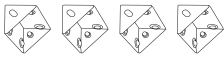
NO	PARTS	QTY	DESCRIPTION
A		1 PC	Left Arm-rest frame
B		1 PC	Right Arm-rest frame
C		1 PC	Back frame
D		1 PC	Sofa front baffle
E		1 PC	Sofa back baffle
F		1 PC	Sofa plate
G		2 PCS	Seat Cushion
H		3 PCS	Back Cushion
I		4 PCS+1	M8*50mm Plum Flower Screw
J		2 PCS+1	M8*20mm Screw
K		8 PCS	Leg

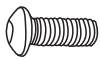
NO	PARTS	QTY	DESCRIPTION
L		8 PCS+1	Washer
M		1 PC	Allen Key
N		2 PCS	Middle Leg
O		4 PCS+1	M6*20mm Screw
P		2 PCS	Footstool baffle
Q		2 PCS	Footstool baffle
R		1 PC	Footstool plate
S		1 PC	Footstool cover
T		4 PCS	Link iron
U		1 PC	Seat Cushion
V		16 PCS+1	M8*20mm Screw

STEP 1

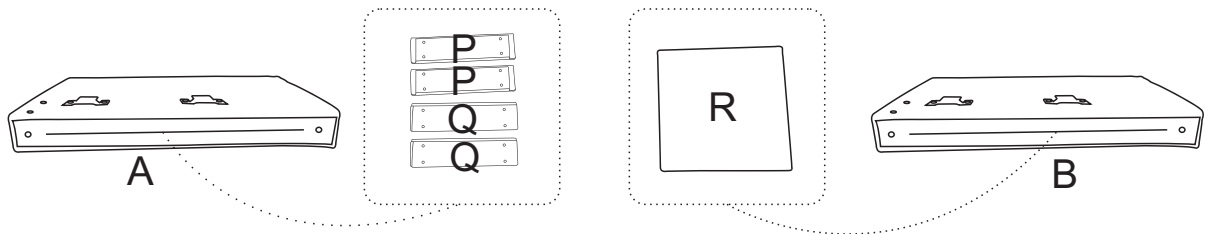

Open A/B and take out the accessory P,Q,R

STEP 2

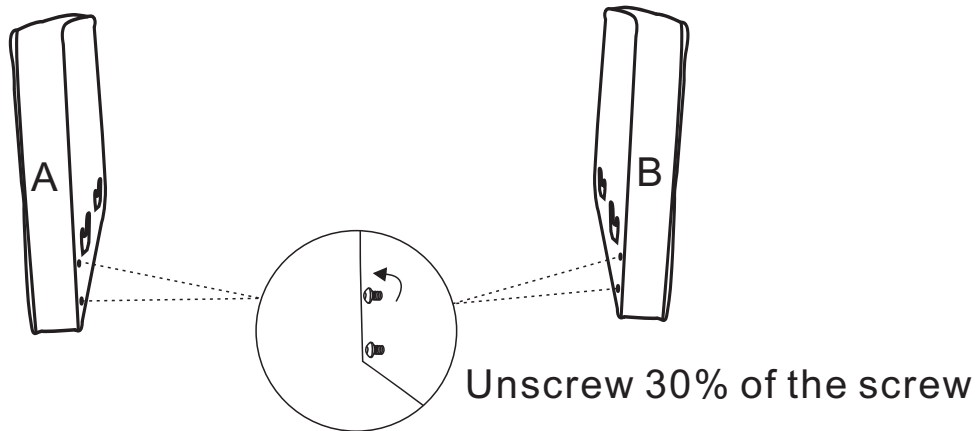

STEP 3

Insert the link iron and tighten the screw

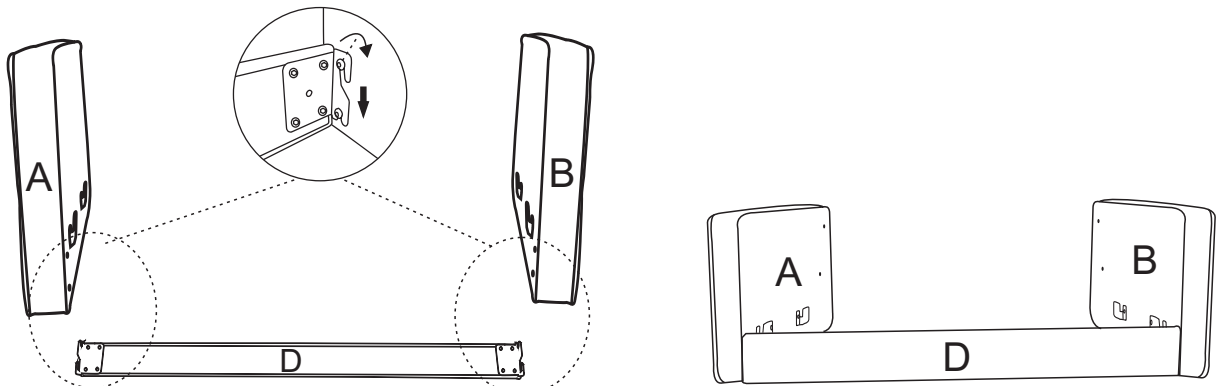

Before the installation

After installation

STEP 4

1. Open the back zipper first
2. Connect C to A/B with I

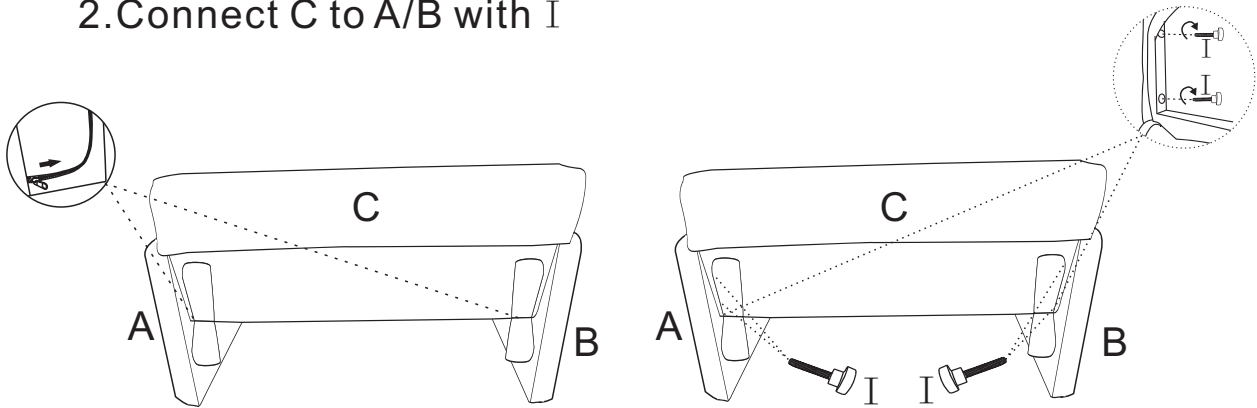

STEP 5

put in F, Link as shown

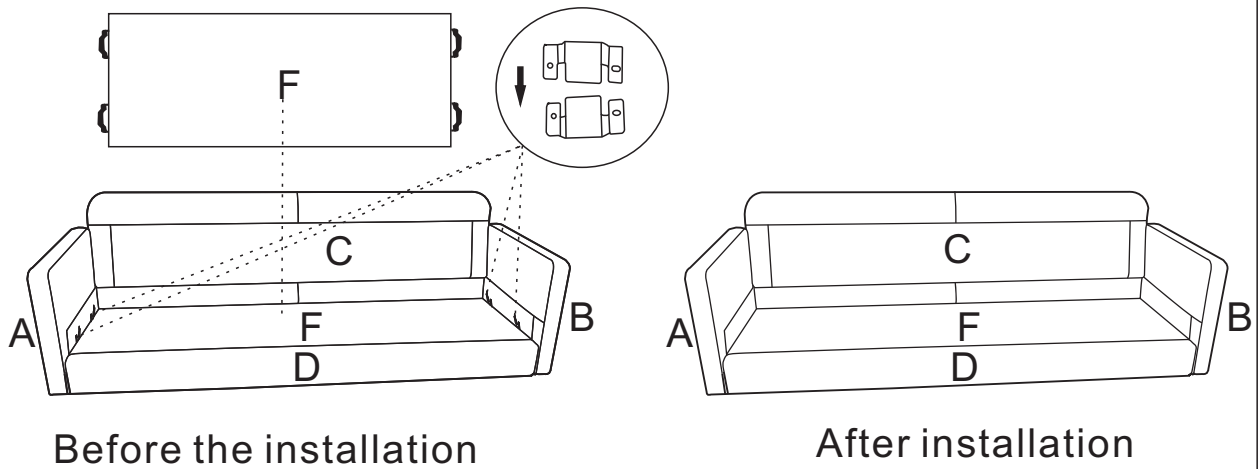

STEP 6

Secure E and A/B with screw J

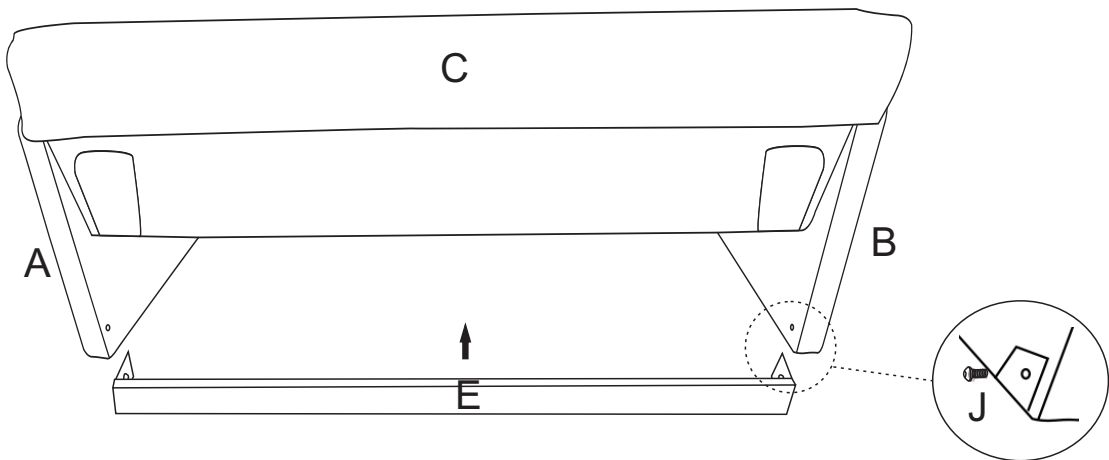

STEP 7

1. Connect N with O
2. Rotate K through L into A/B

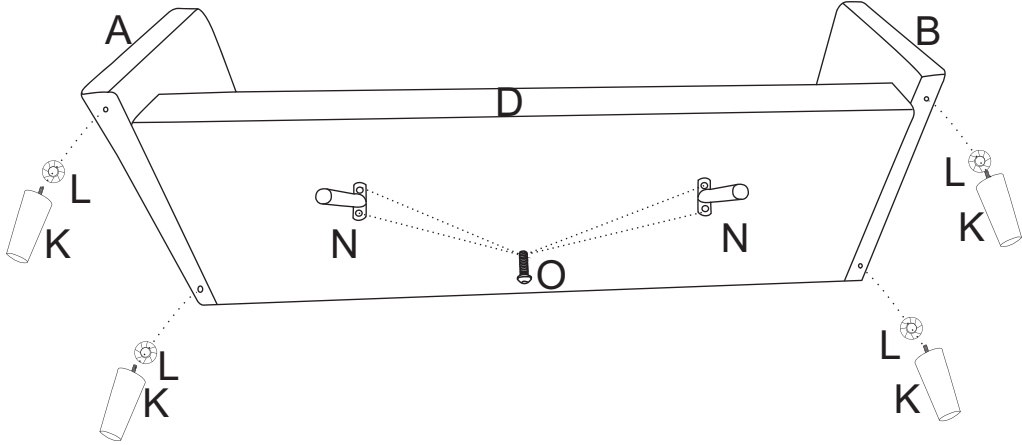

STEP 8

Connect P/Q with T

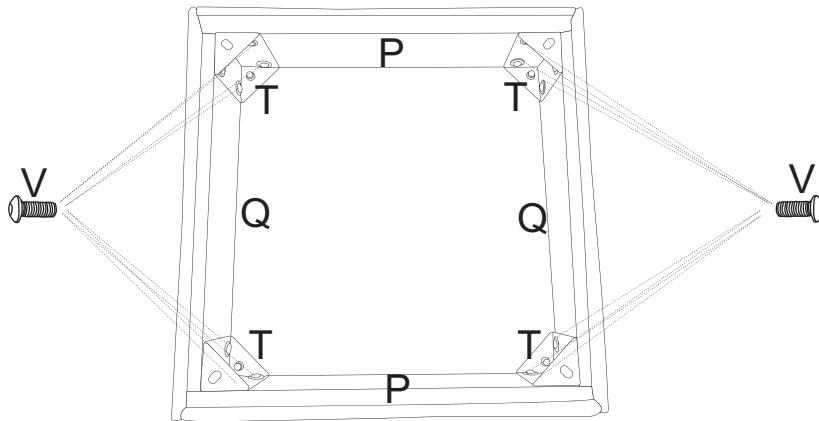

STEP 9

Put in R

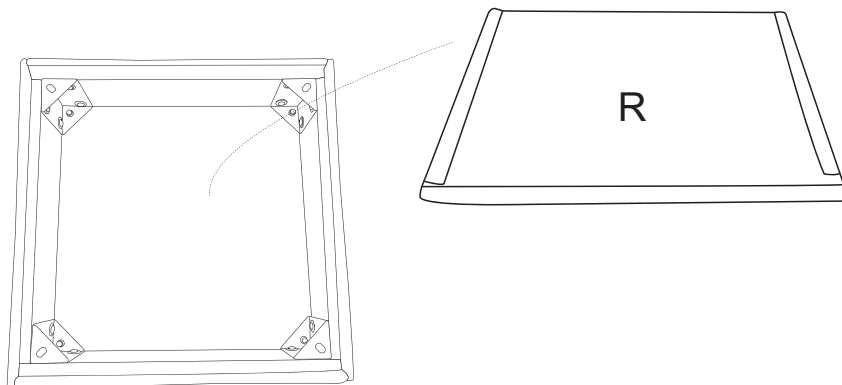

STEP 10

Set into S

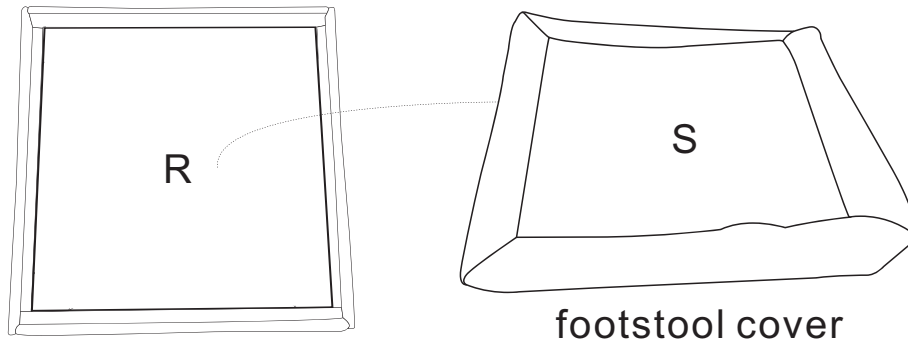

STEP 11

Rotate K through L into T

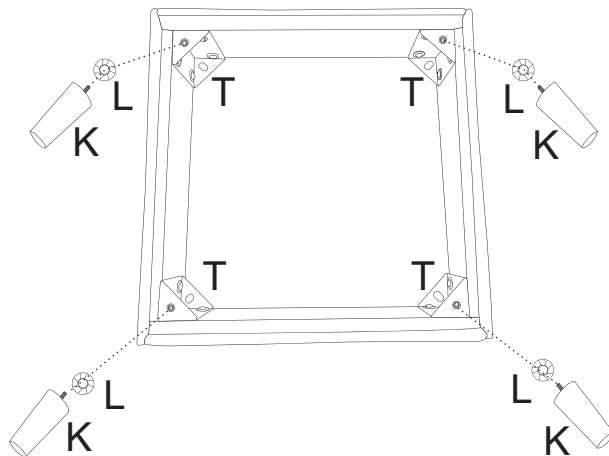

STEP 12

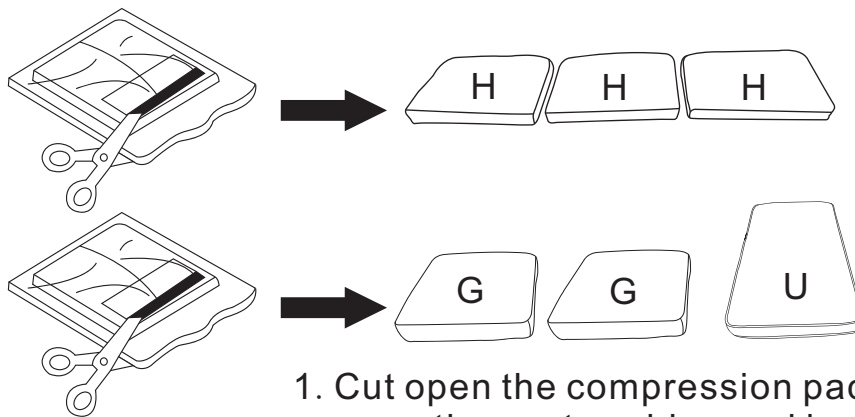

1. Cut open the compression package and remove the seat cushion and back cushion
2. Compression package after cutting, after standing for 24 hours, more comfortable

STEP 13

Have G/U placed respectively

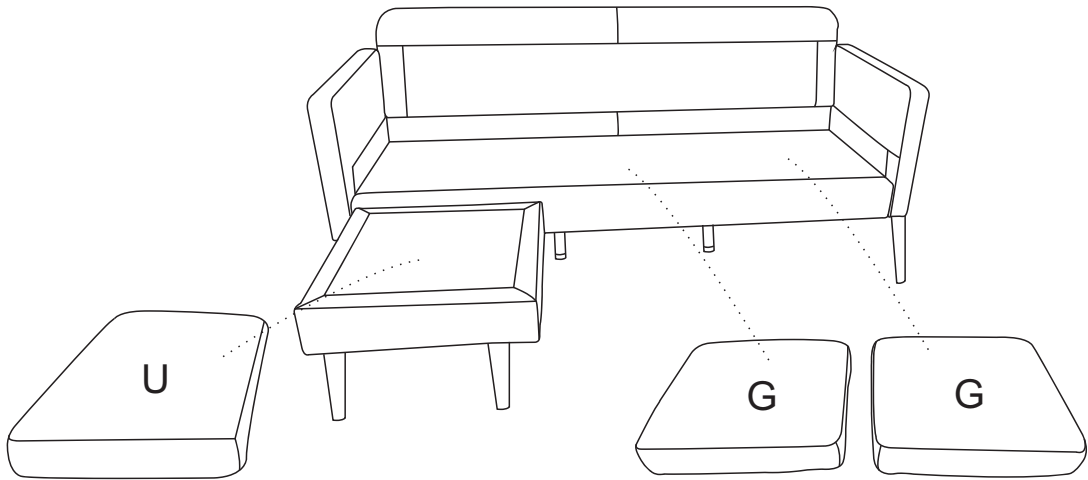

STEP 14

Have H placed respectively

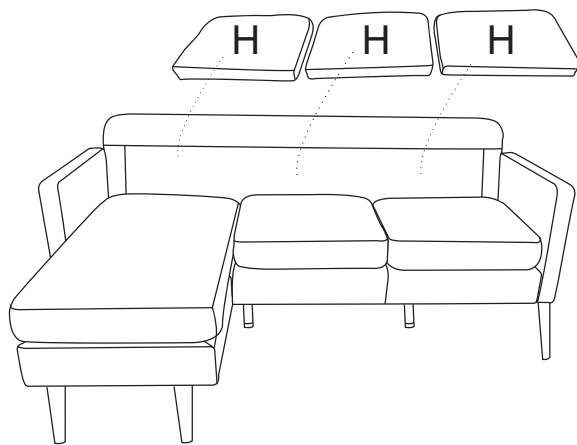

STEP 15

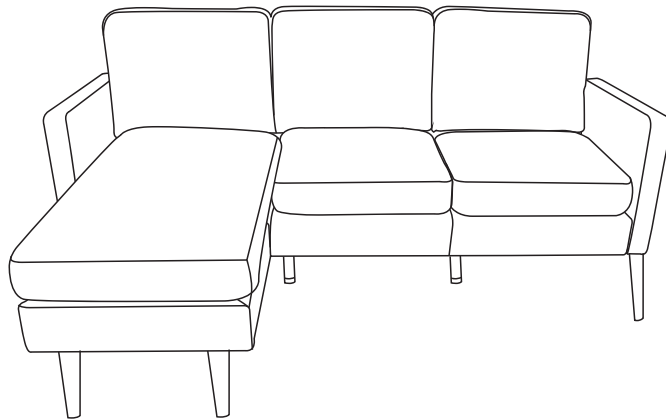

OR

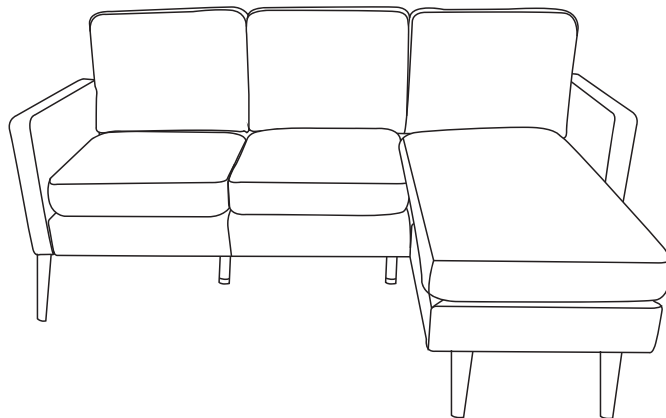

OR

