

# **SUZI**

## **STORAGE SIDEKICK**

### **OWNER'S MANUAL**

#### **Assembly Instructions**

**Model Numbers**    **800 (Oak)**  
                              **801 (White)**  
                              **802 (Cherry)**  
                              **803 (Black)**  
                              **804 (Pistachio Green)**

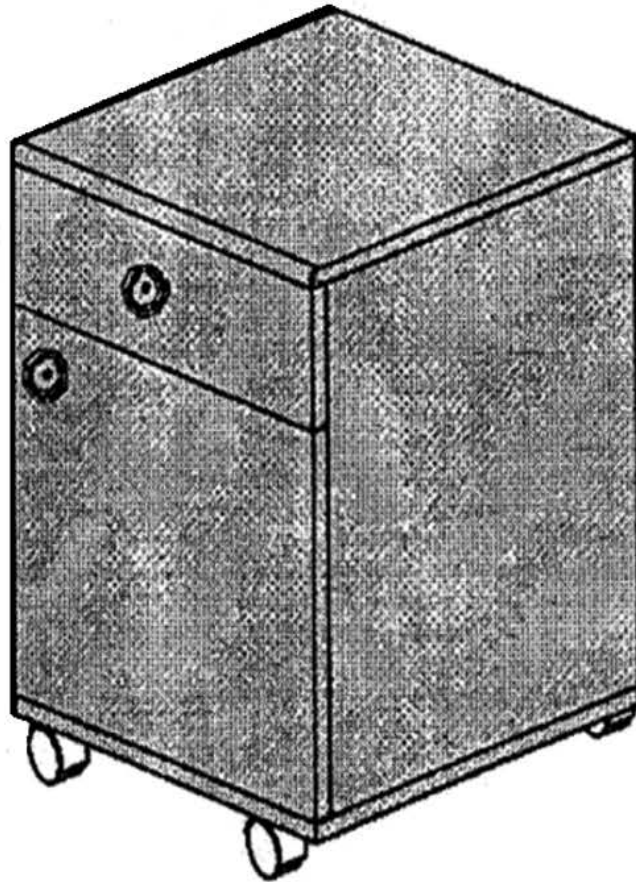

**IMPORTANT: Please read these instructions  
before assembling**

**\*\*Parts are labeled with capital letters. To reference letters,  
turn to the Wood Parts List in the back of your manual.**

# **READ THIS PAGE FIRST**

## **WARRANTY**

Thank you for your purchase of an Arrow Sewing Cabinet! Our products have a three year warranty from the date of shipment for the manufacturer's defects and offer free shipping of parts during the first year. There is a 15 day warranty for shipping damages. The warranty does not cover damage caused by abuse, mis-use, alteration, accident or neglect of the product. The warranty does not cover damage as a result of moving the cabinet fully loaded.

Under the terms of this warranty the repair and replacement of any parts shall be at the discretion of the company or their designated representatives.

**Replacement Part Shipping Policy:** To help protect our valuable resources, we ship all replacement parts out at the same time. This procedure lessens the use of packaging materials and fossil fuels used in transportation in order to reduce pollution. Please help us in this endeavor by reviewing ALL parts in ALL boxes for damage before calling or e-mailing us to report damage. We adhere to our environmental philosophy by only shipping replacement parts out 1 time for free. Future parts requests will be billed at the customer's expense.

**QUESTIONS?**

**CALL US: 1-800-533-7347**

**E-MAIL: [CS@ARROWCABINETS.COM](mailto:CS@ARROWCABINETS.COM)**

**CHECK OUT OUR WEBSITE FOR PICTURES, ASSEMBLY VIDEO,  
AND FREQUENTLY ASKED QUESTIONS AT:  
[WWW.ARROWCABINETS.C](http://WWW.ARROWCABINETS.C)**

**Notice to Customer:**

Before beginning assembly, remove all parts from the carton. Check closely with illustrations below to determine that all the parts are included.

For assembly or operating assistance, or to report any missing or damaged parts, you may call or write to:

1-800-533-7347 cs@arrowcabinets.com

Arrow Cabinets

PO Box 307 Delavan, WI 53115

TO ORDER REPLACEMENT PARTS CALL

**1-800-533-7347**

PLEASE NOTE: To assure proper handling of replacement parts please include the following information:

Model Number of Unit -	800 (Oak)
	801 (White)
	802 (Cherry)
	803 (Black)
	804 (Green)
Production ID Number	
Number of Part Required	
Your Name, Address, and Phone Number	



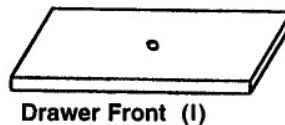
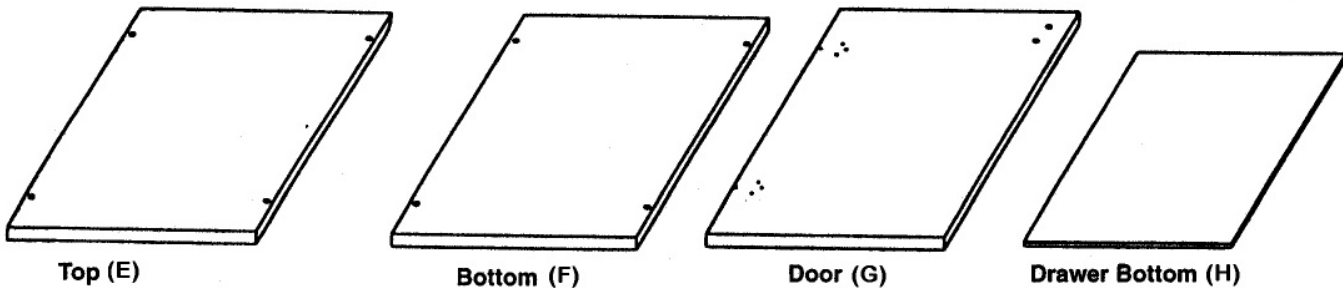
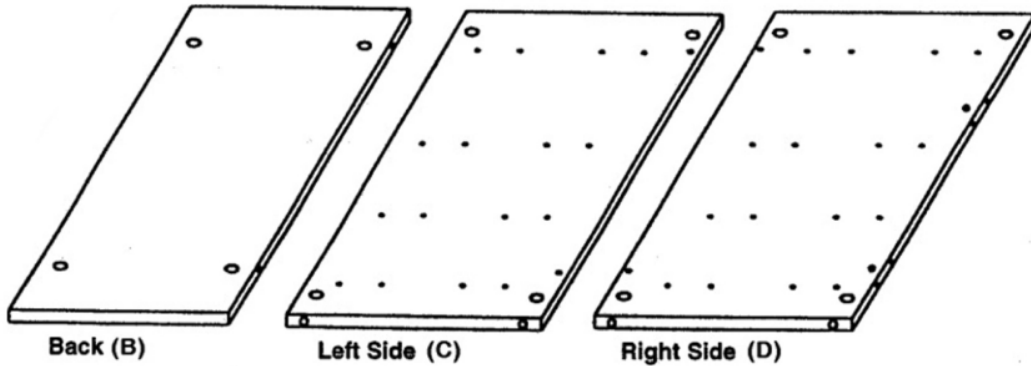







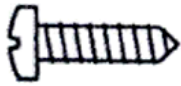

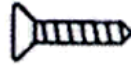

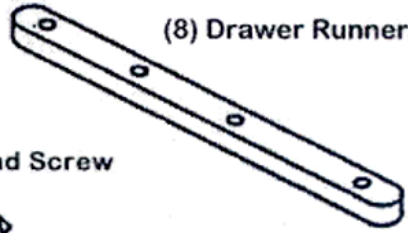
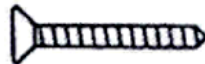
## Wooden Materials

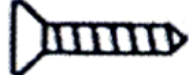

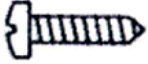
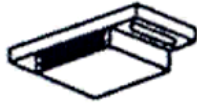
**\*If any of these parts arrived damaged, please call us at 1-800-533-7347 and we will send a replacement part out.**

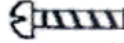
**\*For additional strength dab wood glue on tip of screws before attaching**

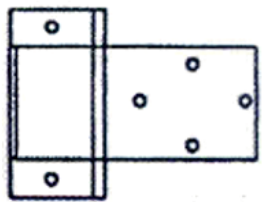
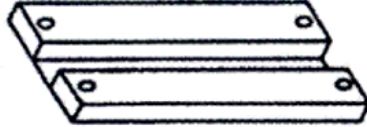
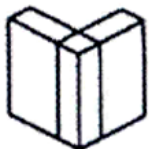
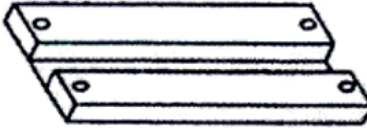
# Hardware Included

<p>(16) #8 x 1/2" Silver Panhead Screws</p>  <p>(4) Plate Casters</p>  <p>(1) #4 x 1/2" Bronze Flathead Screw</p>  <p>(1) Strike Plate</p> 	<p>(8) Drawer Runners</p>  <p>(32) #6x1" Flathead Screw</p> 	
<p>(4) Metal Dowels</p>  <p>(4) Drawer Stoppers</p>  <p>(4) #8 x 5/16" Flathead Screws</p> 	<p>(12) Cams</p>  <p>(12) Connecting Bolts</p> 	
<p>(2) #6 x 5/8" Gold Panhead Screws</p>  <p>(1) Door Magnet</p> 	<p>(1) Door Knob</p>  <p>(1) #8/32 x 1" Door Knob Bolt</p> 	<p>(14) #4 x 1/2" Gold Flathead Screws</p>  <p>(2) Door Hinges</p> 
<p>(8) Drawer Sides (13" Long)</p>  <p>(28) Drawer Connectors</p> 	<p>(7) Drawer Fronts/Backs (11 9/16" Long)</p> 	<p>(1) Pre-Assembled Drawer Front Clip (Attached to drawer front)</p> 

Note: Items sharing a box designate items packaged together in a plastic bag.

\*Items not drawn to scale.

# Understanding How the "ARROW-LOC" Cam Fastener Works.

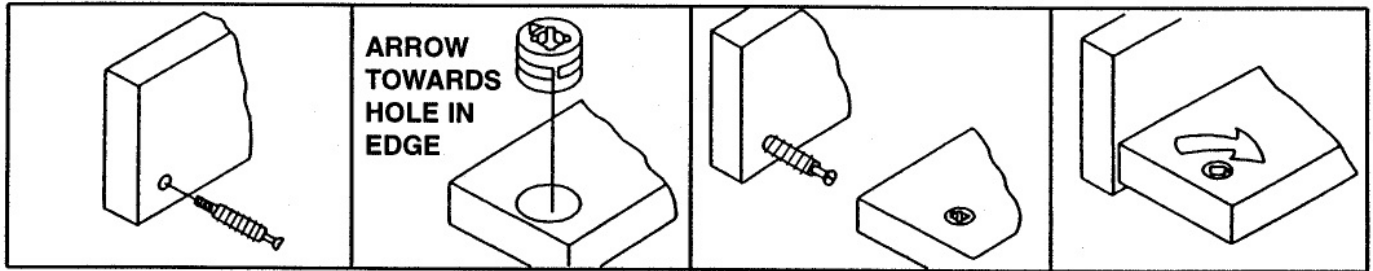

1. Position bolt in pre-drilled hole and turn until tight.
2. Press cam into pre-drilled hole until flush with surface. **ARROW TOWARDS HOLE IN EDGE**
3. Insert bolt through pre-drilled hole in edge of panel.
4. To lock, rotate cam until tight, using allen key provided.

## Cabinet Assembly

Step 1. Place Top(E), Bottom(F), Back (B), Left and Right Sides(C, D) on a flat protected surface(to prevent scratching of parts). Thread Connecting Bolts(12 total) into pre-drilled holes (as shown in FIG. 1). Install Cams (12 total) by pushing a Cam into each, hole flush with surface. The arrow on the Cams should be turned to face the hole, in each edge where the Connecting Bolts will enter, using a regular screwdriver or Allen Key provided.

### NOTE:

- = Connecting Bolt
- ⊖ = Cam

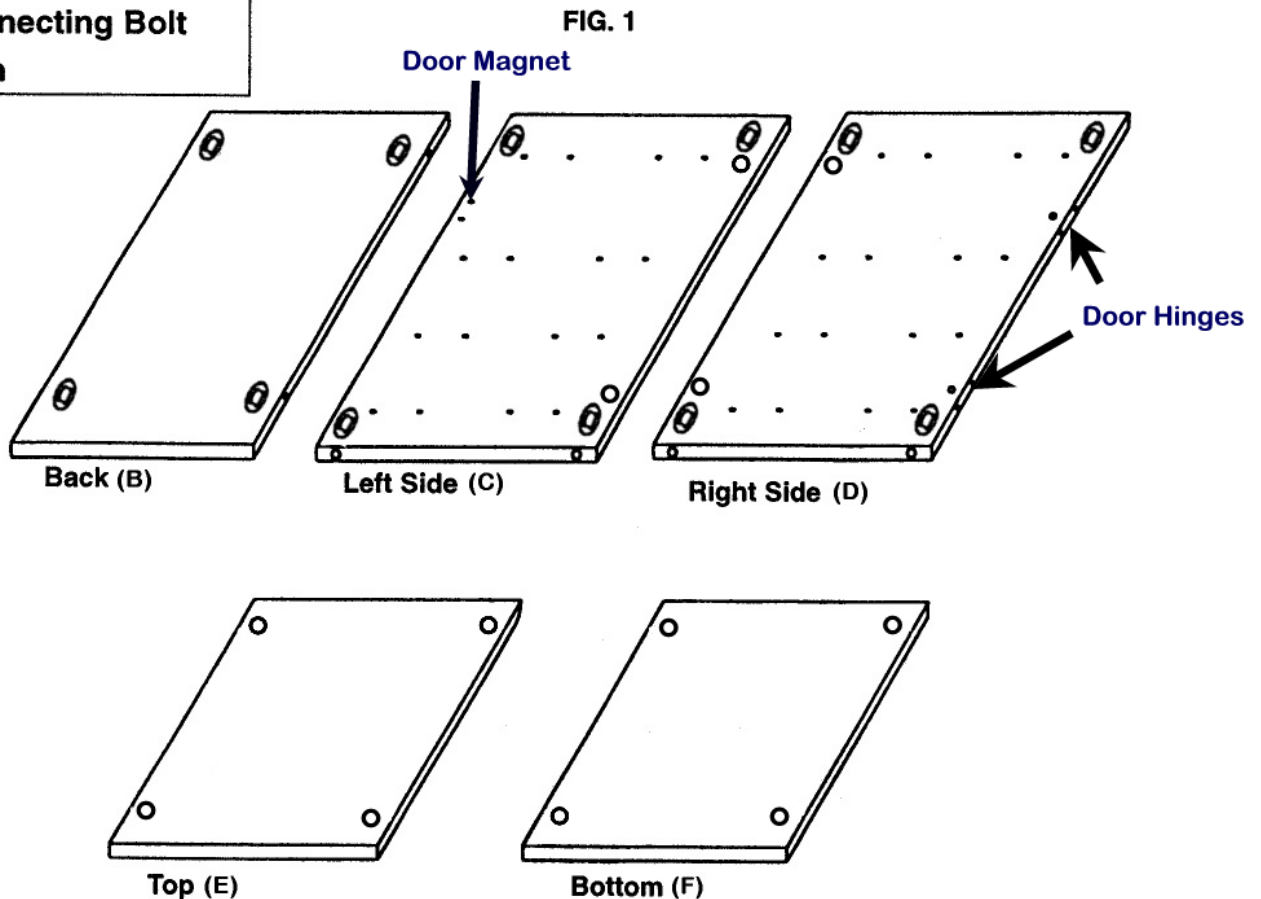

**STEP 2** Attach (8) Drawer Runners to Left and Right Sides (C,D) using (32) #6x1" Flathead Screws. Attach on Right Side (D) (2) Door Hinges using (6) #4x1/2" Flathead Screws. Attach on Left Side (C) (1) Door Magnet using (2) #6x5/8" Panhead Screws (as shown in Fig. 2). The Metal side of the magnet faces panel edge.

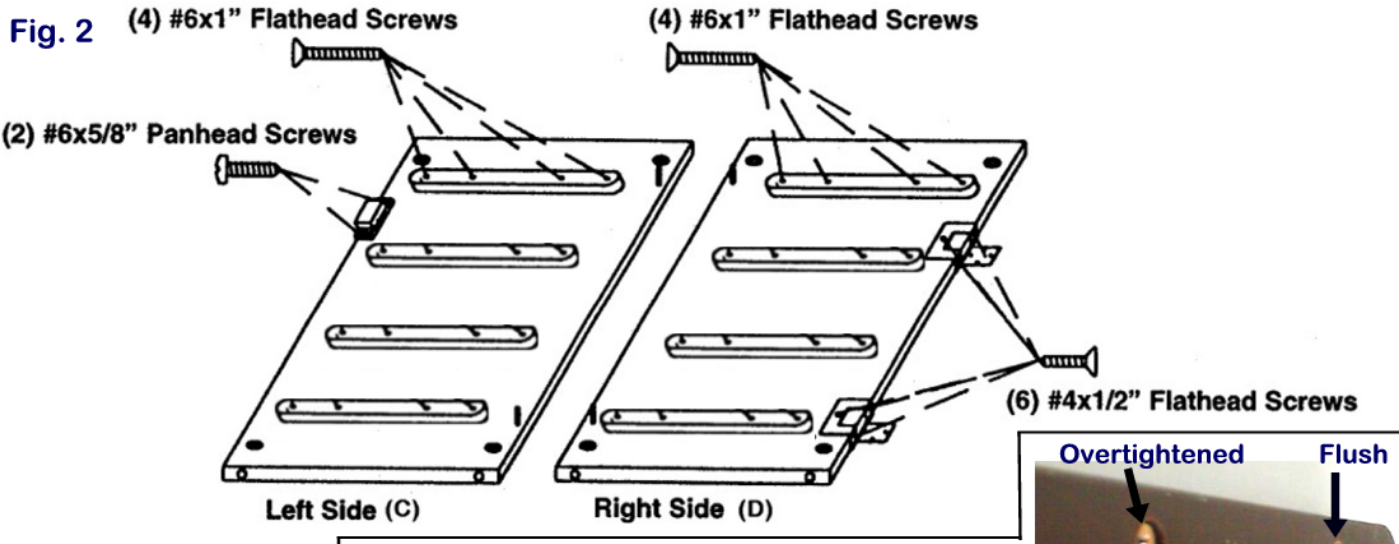

**\*\*DO NOT OVERTIGHTEN #6x1" Flathead Screws. Make sure the screw heads are flush with plastic.\*\***

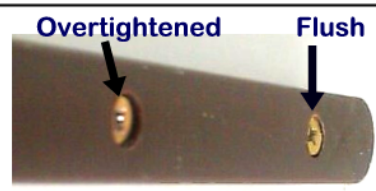

**STEP 3.**

Screw drawer stops (4) into Right Side Panel (D) above drawer runner using (4) #8x5/16" Flathead screws. **DO NOT** tighten the screws completely, leave 1/4" for up and down swivel of the drawer runner. Insert (4) metal dowels into pre-drilled hole next to drawer stop.

**Fig. 3.**

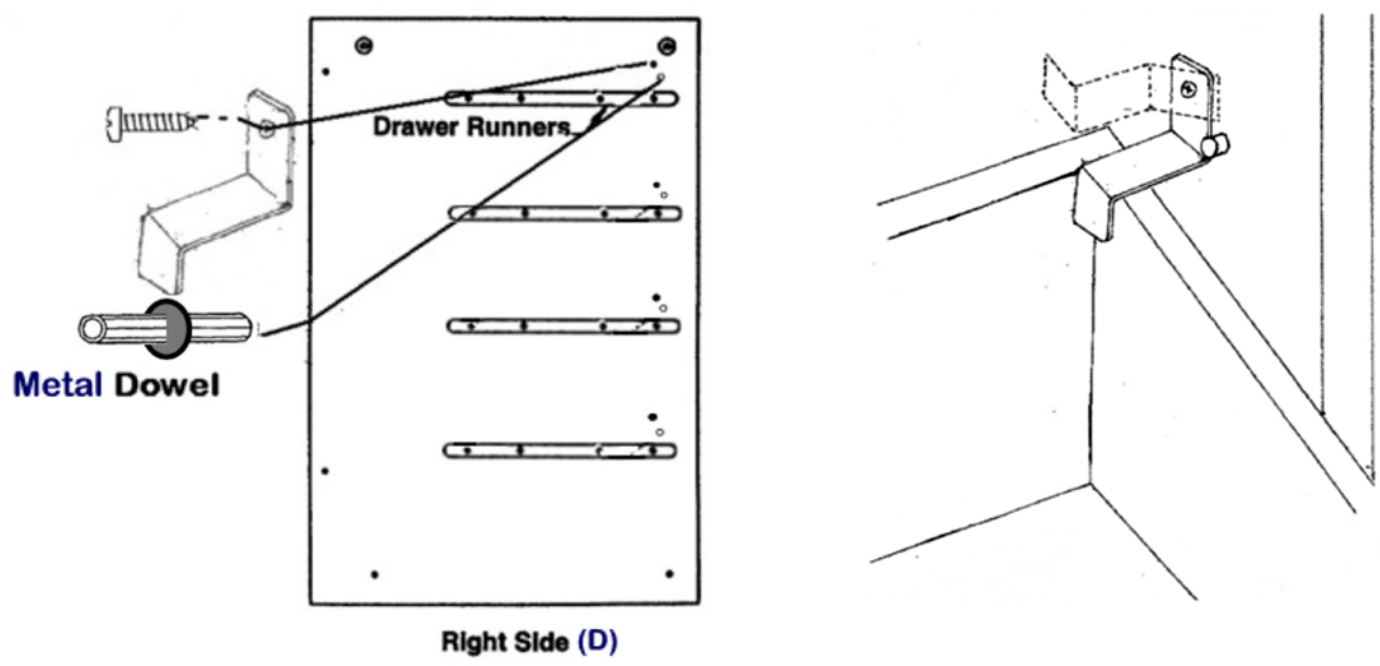

**STEP 4. Attach (4) Plate Casters to Bottom (F) using (16) #8x1/2" Panhead Screws into holes provided (as shown in FIG.4).**

**Fig. 4.**

(16) #8x1/2" Panhead Screws

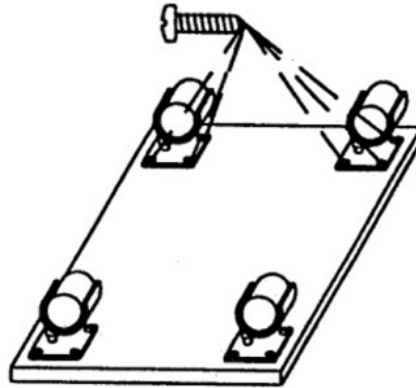

\* For additional strength dab wood glue on the tip of screws before attaching.

Bottom (F)

**STEP 5. With Cams facing inward, Attach Left Side (C) to Back (B), guide Connecting Bolts into holes in Back (B), turn Cams to locked position. Attach Right Side (D) to Back (B), guide Connecting Bolts into holes in Back (B), turn Cams to locked position (as shown in Fig.5). Sides and back will be flush at the top.**

**Fig. 5.**

\*Remember to tighten the cams down on ALL pieces once completed!

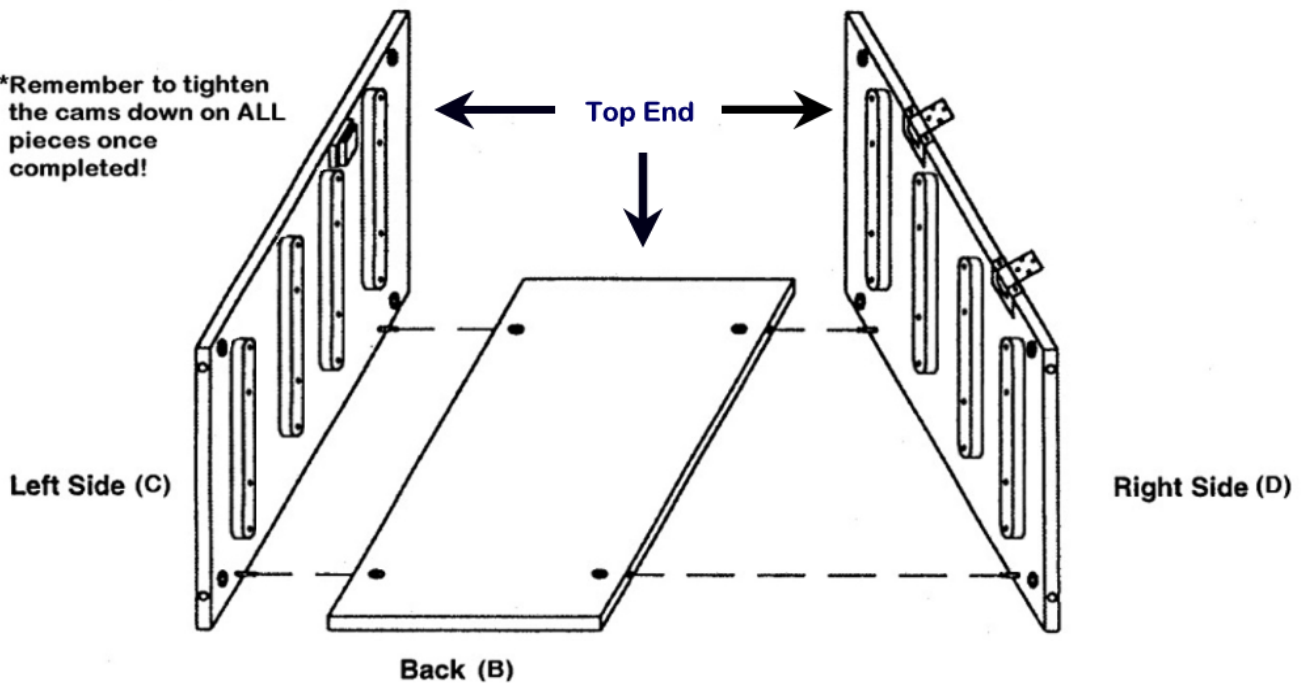

**Step 6.** Place Top (E) on floor, guide Sides (C,D) and Back (B) assembly onto Connecting Bolts, turn Cams to locked position. Attach Bottom (F) w/casters, guide Connecting Bolts into Holes in Sides (C,D), turn Cams to locked position (as shown in FIG. 6).

Note: Caddy is being assembled upside down.

**Fig. 6.**  
Side Assembly

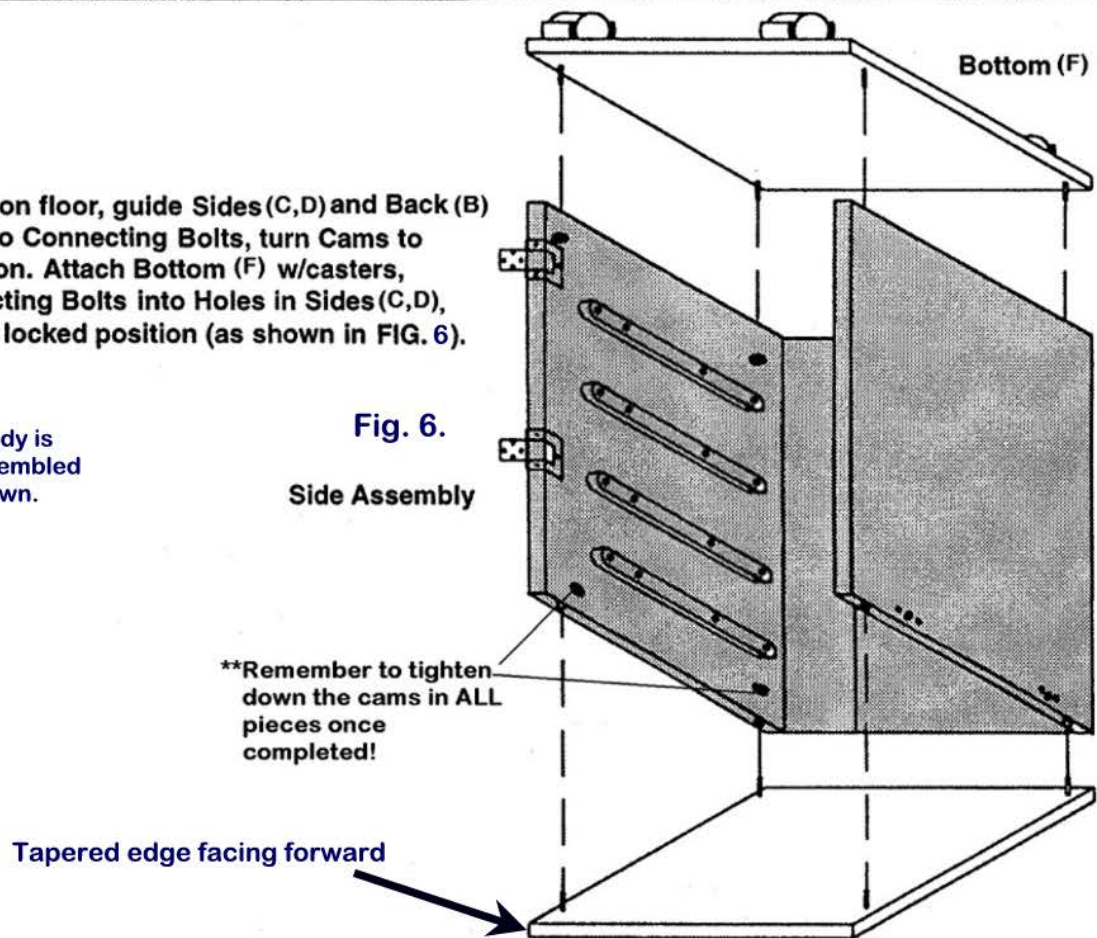

**Step 7:** Laying Caddy on its Back (B), attach Door (G) using (8) #4 x 1/2" flathead screws. Attach Door Knob onto the Door (G) as shown below in FIG. 7. Attach Strike Plate with (1) #4 x 1/2" flathead screw, to Door (G).

**Fig. 7.**

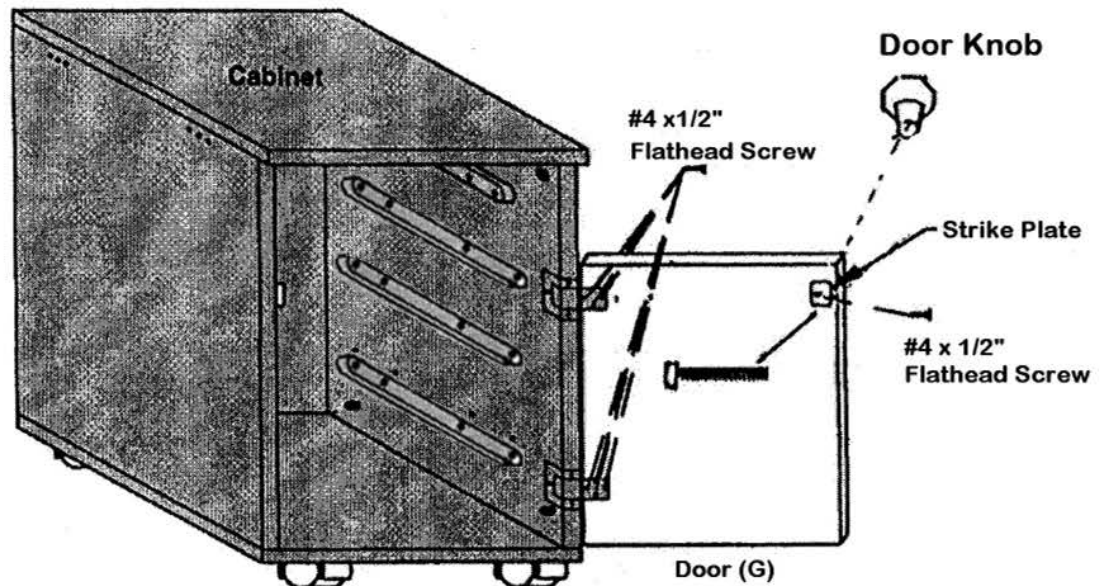

## Step 8

### PLEASE NOTE:

**BE SURE TO KEEP GROOVES IN DRAWER PART (FOR DRAWER BOTTOM) ALIGNED WHEN ASSEMBLING THE DRAWER.**

### Assembling the Drawer

Begin Drawer assembly by inserting (4) Drawer Connectors into the ends of the Drawer Back, (as shown in FIG. A). Push Connectors all the way into the Drawer Back until the tabs lock into place.

Fig. A

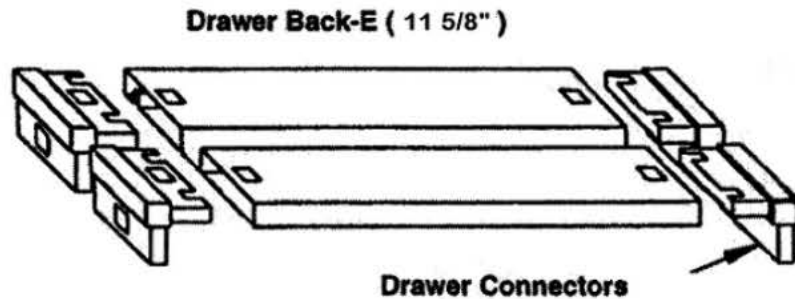

### Drawer Assembly

**Step A** Attach DRAWER Sides B and C to Drawer Front-A. Align Drawer Bottom grooves in Sides with Drawer Bottom groove in Drawer Front. Snap Drawer Sides onto clips on Drawer Front (see FIG. B).

**Step B** Slide Drawer Bottom-D along grooves on the Sides into the Groove in Drawer Front.

**Step C** Align groove in Back-E with the Drawer Bottom-D and snap Back corner clips into Sides-B and C.

**Step D** Attach the Knob to the Drawer Front using (1) 8/32x1" Bolt for Knob, and attach to Drawer.

FIG. B

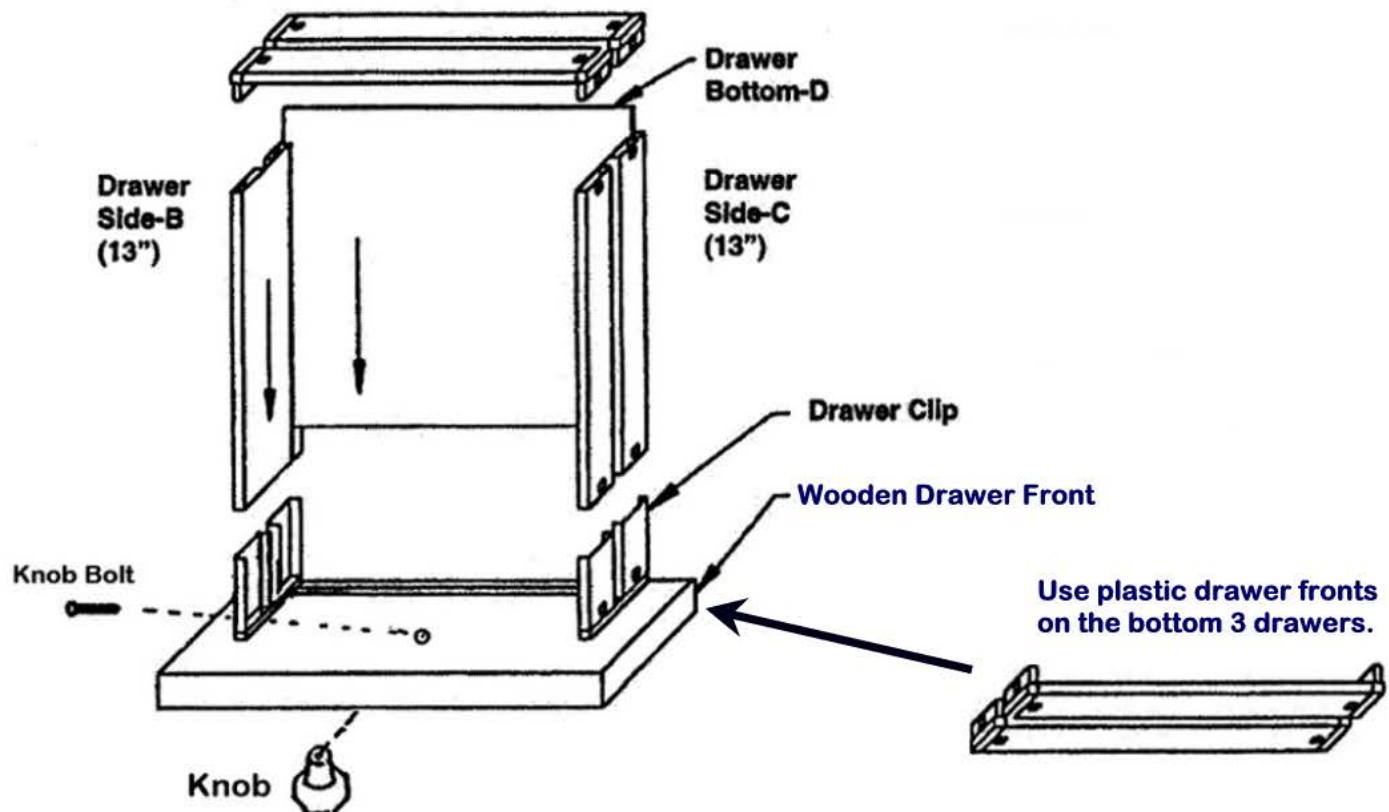

The Drawer may now be installed into your cabinet.

## Wood Parts and Part Numbers

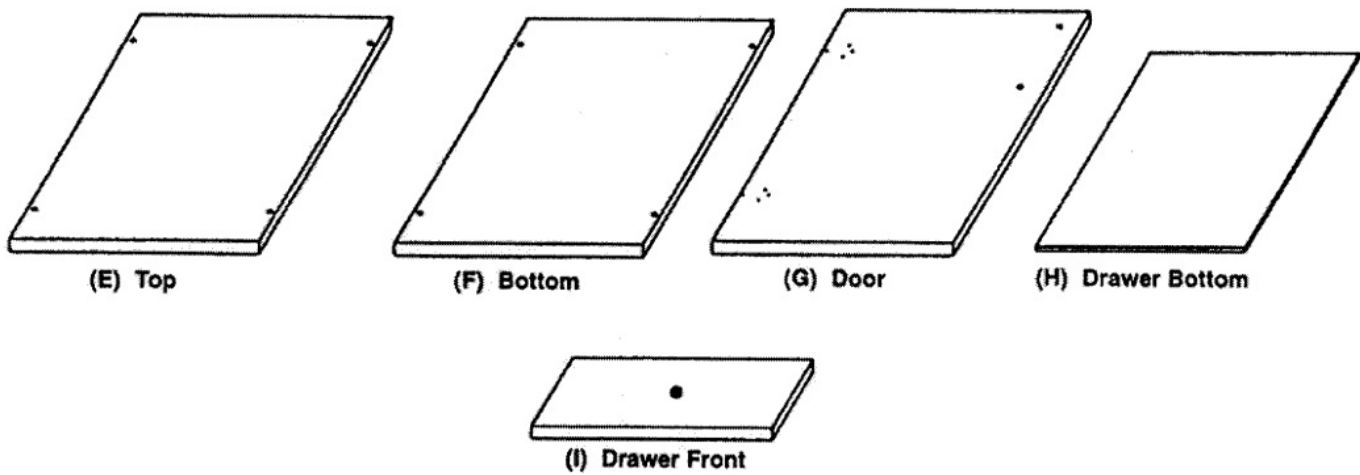
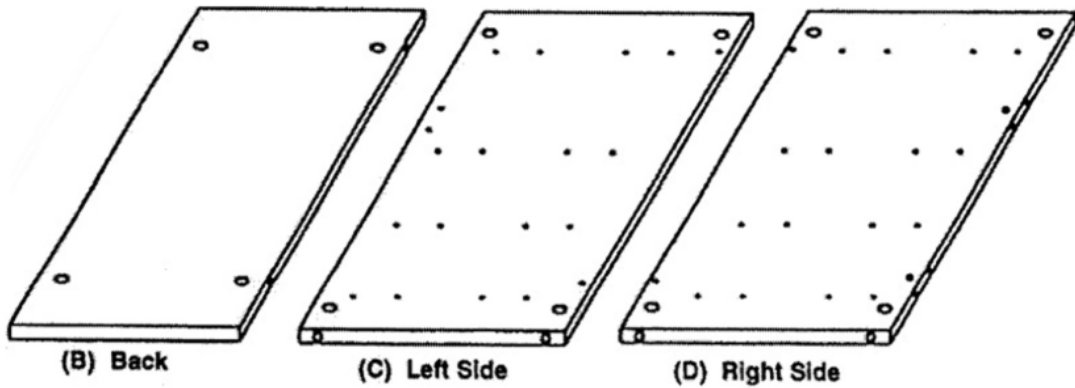

Ref.	Description	Part #	Part #	Part #	Part #	Part #
	<b>Cabinet Model #</b>	<b>800 (Oak)</b>	<b>801 (White)</b>	<b>802 (Cherry)</b>	<b>803 (Black)</b>	<b>804 (Grn)</b>
<b>B</b>	<b>Back</b>	<b>003315</b>	<b>003252</b>	<b>003315C</b>	<b>003315B</b>	<b>003315G</b>
<b>C</b>	<b>Left Side</b>	<b>003314</b>	<b>004020</b>	<b>003314C</b>	<b>003314B</b>	<b>003314G</b>
<b>D</b>	<b>Right Side</b>	<b>003313</b>	<b>003250</b>	<b>003313C</b>	<b>003313B</b>	<b>003313G</b>
<b>E</b>	<b>Top</b>	<b>003317</b>	<b>003254</b>	<b>003317C</b>	<b>003317B</b>	<b>003317G</b>
<b>F</b>	<b>Bottom</b>	<b>003316</b>	<b>003253</b>	<b>003316C</b>	<b>003316B</b>	<b>003316G</b>
<b>G</b>	<b>Door</b>	<b>003318</b>	<b>003255</b>	<b>003318C</b>	<b>003318B</b>	<b>003318G</b>
<b>H</b>	<b>Drawer Bottom</b>	<b>003162</b>	<b>003162</b>	<b>003162</b>	<b>003162</b>	<b>003162</b>
<b>I</b>	<b>Drawer Front</b>	<b>003320</b>	<b>003257</b>	<b>003320C</b>	<b>003320B</b>	<b>003320G</b>

# Hardware Included with Part Numbers

(A) #8x1/2" Panhead Screw



(B) #4x1/2" Flathead Screw

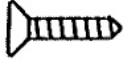

(C) #8x5/16" Flathead Screw

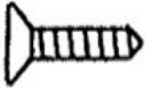

(E) #6x1" Flathead Screw

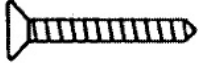

(F) #6x5/8" Panhead Screw

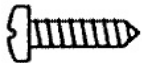

(G) Connecting Bolt



(H) Drawer Connector



(I) Manual



(J) Metal Dowel



(K) Cam



(D) Drawer Stopper

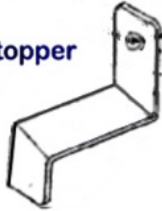

(L) Plate Caster



(M) Magnet

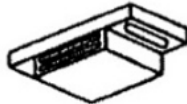

(X) 8/32x1" Bolt

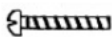

(U) Drawer Side (13")

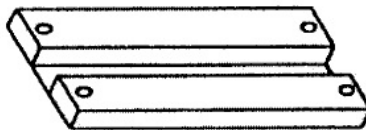

(P) Door Hinge

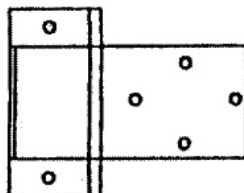

(Q) Drawer Runners

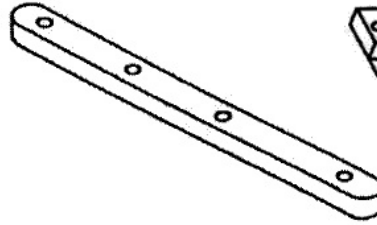

(V) Drawer Front/Back (11-9/16")

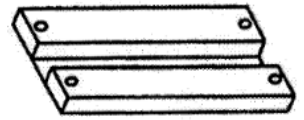

(S) Strike Plate



(O) Pre-Assembled Drawer Front Clip (Attached to drawer front)

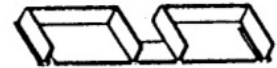

(W) & (T) Knob

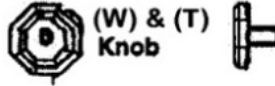

Item	Description	Part No.
A	#8x1/2" Panhead Screw	002614
B	#4x1/2" Flathead Screw	002705
C	#8x5/16" Flathead Screw	002000
D	Drawer Stopper	002001
E	#6x1" Flathead Screw	001325
F	#6x5/8" Panhead Screw	000083
G	Connecting Bolts	002892
H	Drawer Connector	003142C
I	Manual	003151B
J	Metal Dowel	002002
K	Cam	000709
L	Plate Caster	002190
M	Magnet	001644
O	Drawer Clip	003138
P	Door Hinge	002730
Q	Drawer Runner	002397
S	Strike Plate	002192
T	Knob Gold (Model 800/802)	003170
U	Drawer Side	003153
V	Drawer Front/Back	003154
W	Knob Silver (Model 801/803)	003165
X	8/32x1" Bolt	003192



**P.O. Box 307 Delavan, WI 53115**

**1-800-533-7347**

**cs@arrowcabinets.com**

**Website:**

**www.arrowcabinets.com**

**08-08**