

Assembly Instructions

Caution: You must read this before you proceed.

Bed

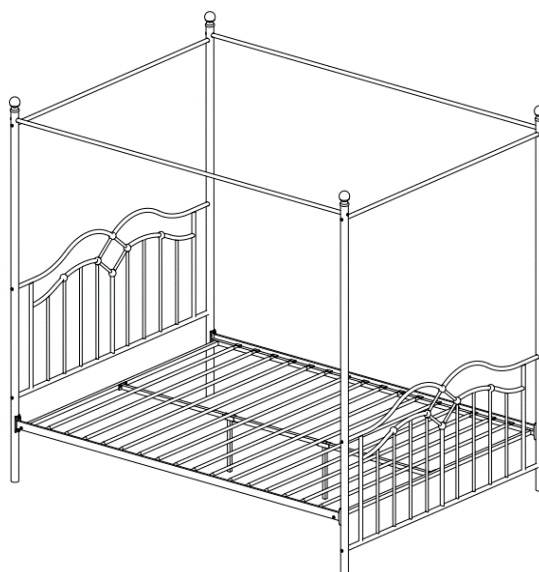

 **WARNING**
STRANGULATION HAZARD.

NEVER place bed near windows where cords from blinds or drapes may strangle a child.

NEVER suspend strings over bed.

NEVER place items with a string, cord, or ribbon, such as hood strings or pacifier cords, around a child's neck.

These items may catch on bed parts.



ALWAYS follow assembly instructions.

 **WARNING!**

Not intended for children under the age of six. **INFANTS HAVE DIED FROM BECOMING ENTRAPPED IN BEDS.** Openings in and between bed parts can entrap the neck and head of a small child. NEVER use bed for child under the age of six.



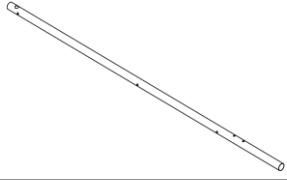
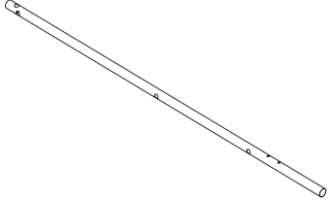
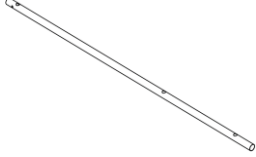
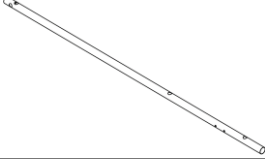
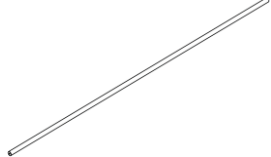
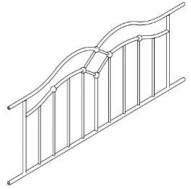
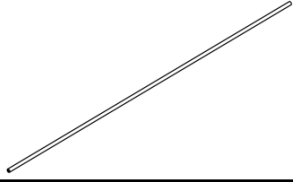
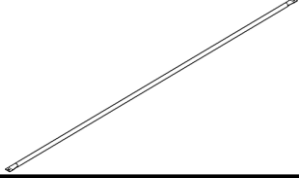

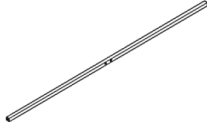

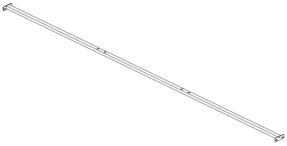
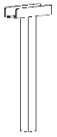
The mattress must be appropriately sized for the bed. If the mattress is undersized, dangerous gaps can exist and a person can become entrapped or entangled in the frame and suffocate.

Part List

Label	Picture	Description	QTY
A		Left Headboard Post	1
B		Right Headboard Post	1
C		Left Footboard Post	1
D		Right Footboard Post	1
E		Short Upper Support Rail	2
F		Headboard/Footboard	2
G		Long Upper Support Rail	2
H		Slat	16
I		Side Rail	2
J		Support Rail	2

K		Finial	4
L		Center Support Rail	1
M		Support Leg	2

Hardware

Label	Picture	Description	QTY
①		Bolt(M6 x 46mm)	5
②		Bolt(M6 x 16mm)	33
③		Spring Washer φ6.5mm	9
④		Flat Washer φ6.5mm	9
⑤		Allen Key 4mm	1
⑥		Slat Connector	38

Assembly Preparation

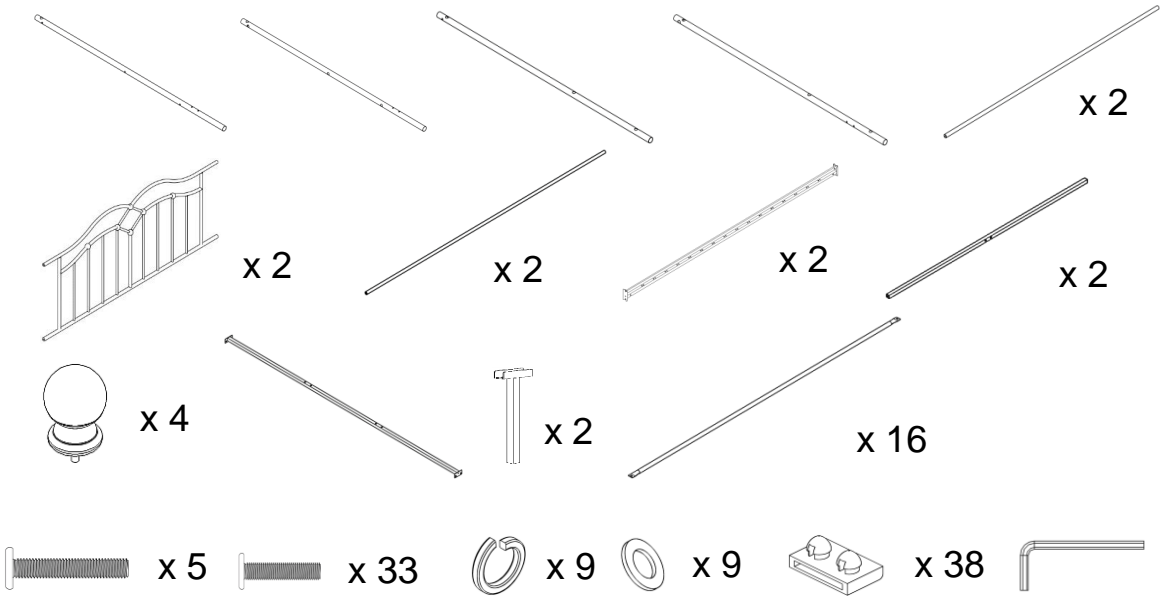
<p>Before Beginning Assembly:</p>	
-----------------------------------	--



- Read instructions, cover to cover-



- Have 3-4 adults on hand for assembly-



- Do not assemble on flooring or carpet-



- Assemble on a clean non-marring surface (packing foam)-



- Save all packaging until finished-

Assembly Steps

Overview

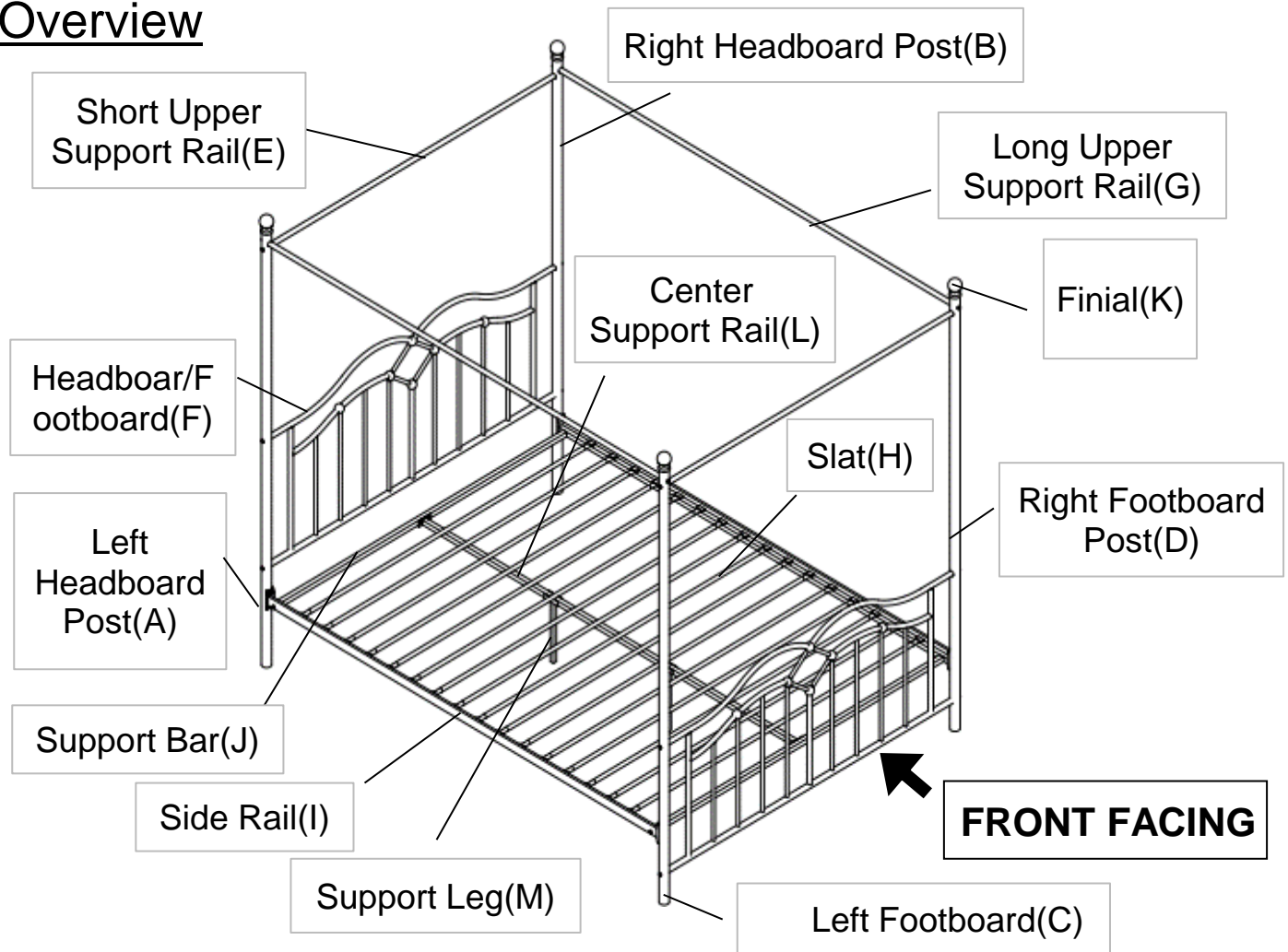

This bed has multiple parts and may require up to some 60 minutes to assemble.

To give you an overview of the bed parts, the above picture is to help you put the various parts into perspective.

Please read through the instructions below to familiarise yourself with the parts and steps before assembly.

Step 1

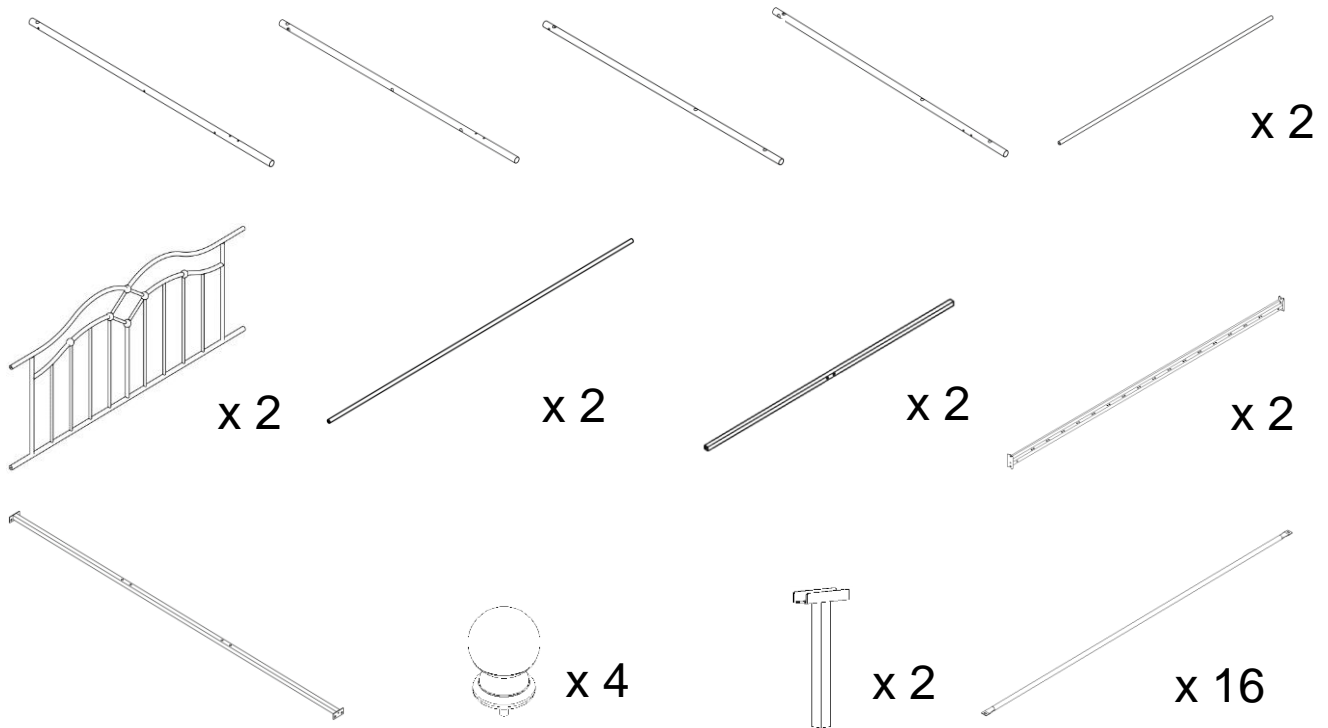

Unpack and place all parts for clear visibility.

Step 2

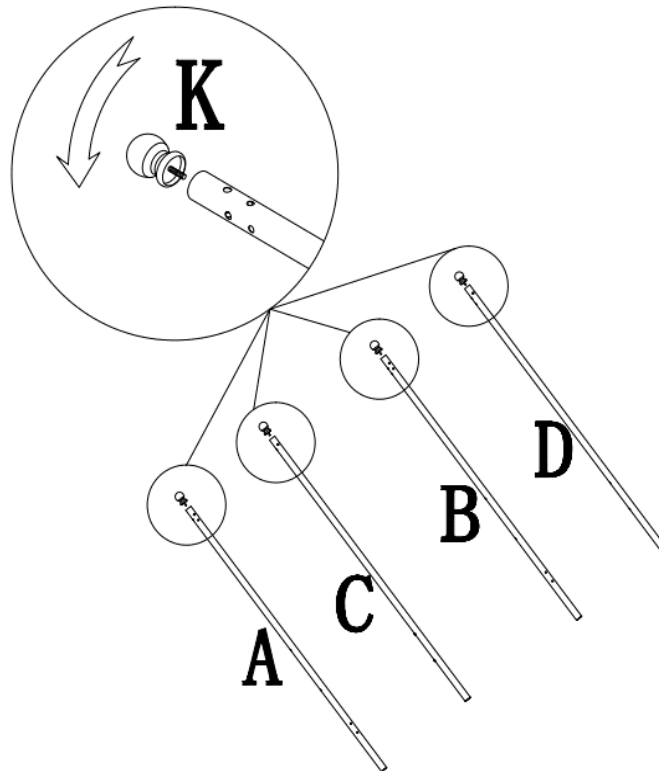

Attach Finials(K) to mounting positions on Left Headboard Post(A), Right Headboard Post(B), Left Footboard Post(C) and Right Footboard Post(D) by turn clockwise by hand.

Step 3

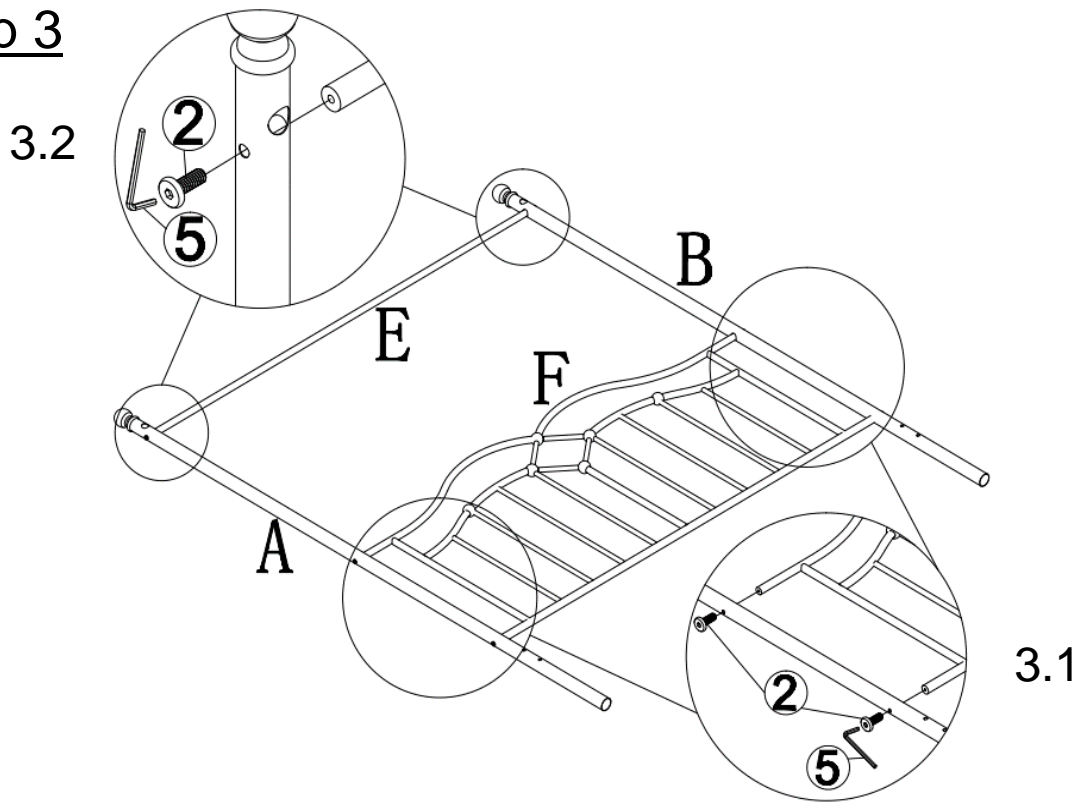

3.1) Attach Left Headboard Post(A) to Headboard/Footboard(F) using Bolt(②) with Allen Key(⑤).

Repeat the same step to assemble Right Headboard Post(B) to Headboard/Footboard(F).

3.2) Attach Short Upper Support Rail(E) to Left Headboard Post(A) and Right Headboard Post(B) using Bolt(②) with Allen Key(⑤) as pix shown.

Do not fully tighten the Bolts.

Step 4

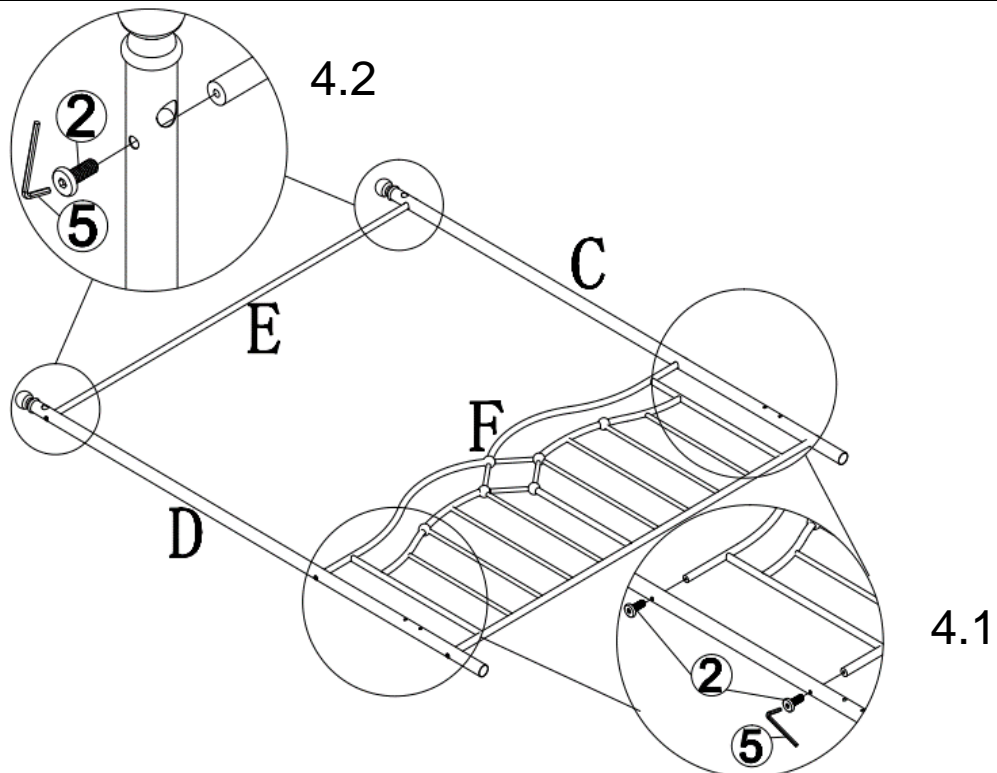

4.1) Attach Left Footboard Post(C) to Headboard/Footboard(F) using Bolt(②) with Allen Key(⑤).

Repeat the same step to assemble Right Footboard Post(D) to Headboard/Footboard(F).

4.2) Attach Short Upper Support Rail(E) to Left Footboard Post(C) and Right Footboard Post(D) using Bolt(②) with Allen Key(⑤) as pix shown.

Do not fully tighten the Bolts.

Step 5

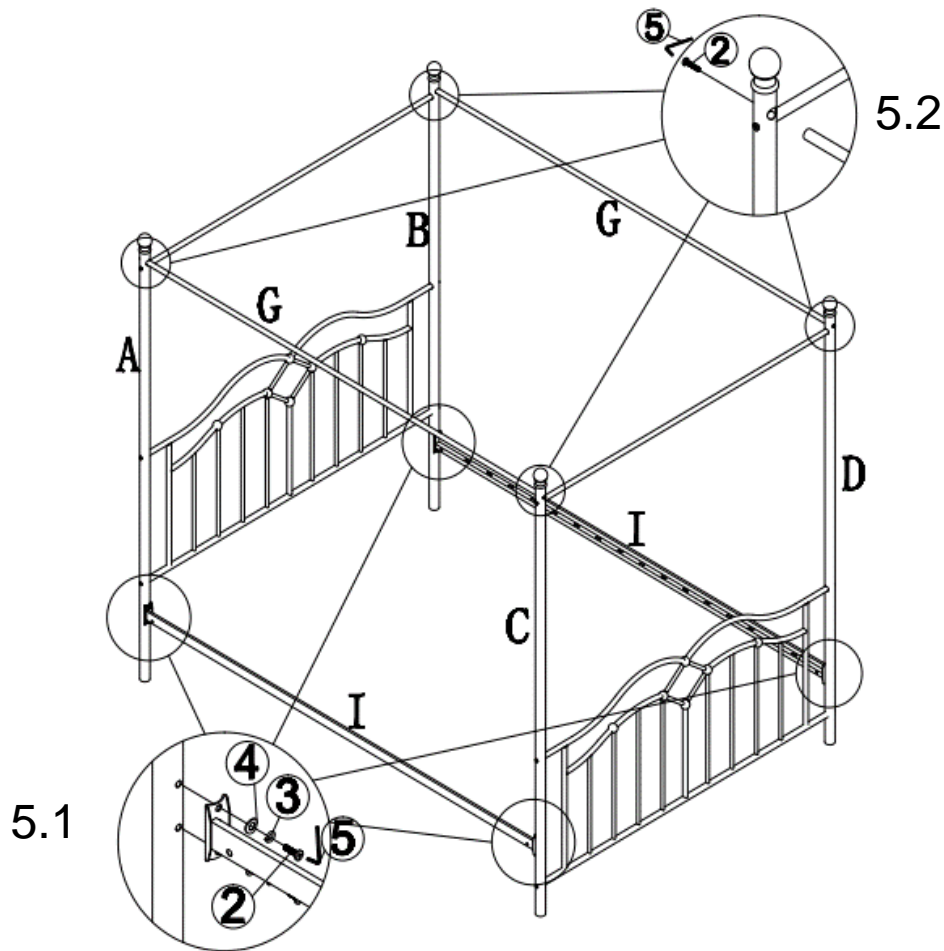

5.1) Place the Headboard frame and Footboard frame right side up.

Then, attach Side Rail(I) to Left Headboard Post(A) and Left Footboard Post(C) using Bolts(②), Spring Washer(③) and Flat Washer(④) with Allen Key(⑤).

Repeat same step to assemble the other Side Rail(I) to Right Headboard Post(B) and Right Footboard Post(D).

5.2) Attach Long Upper Support Rail(G) to Left Headboard Post(A) and Left Footboard Post(C) using Bolts(②) with Allen Key(⑤).

Repeat same step to the other Long Upper Support Rail(G) to Right Headboard Post(B) and Right Footboard Post(D).

Step 6

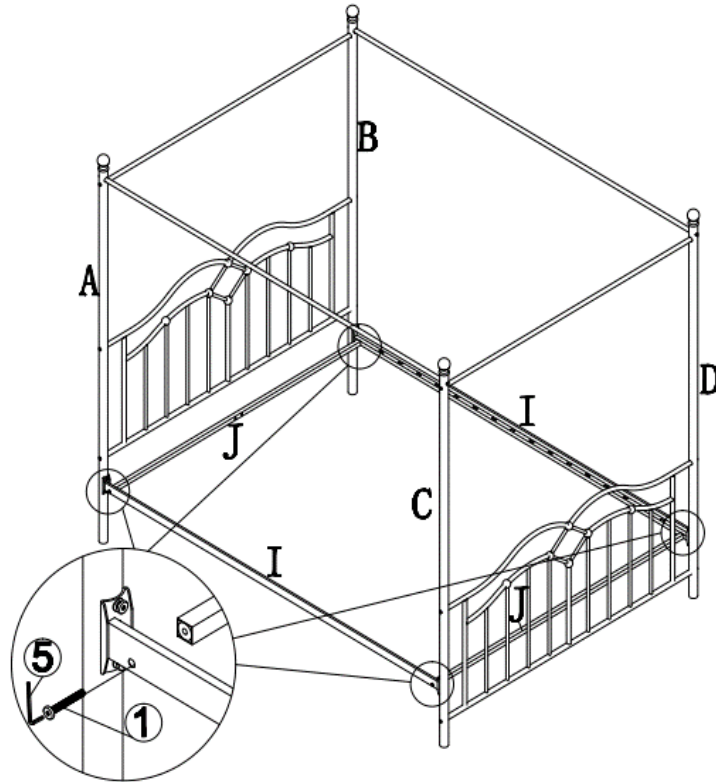

Attach Support Rail(J) to Side Rail(I) using Bolts(①) with Allen Key(⑤).

Step 7

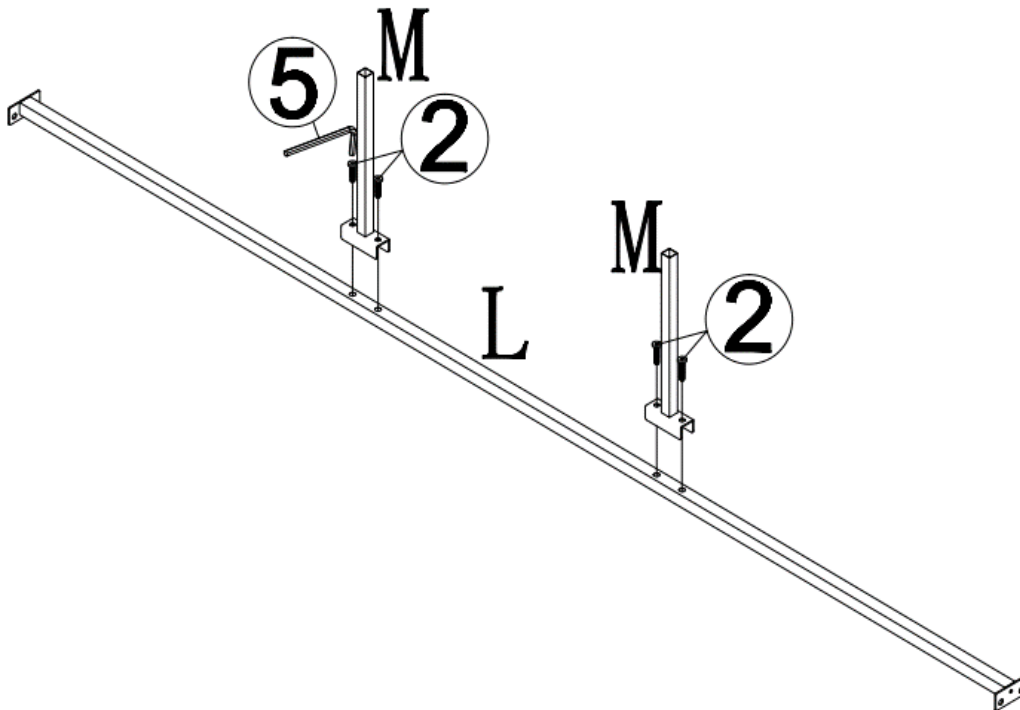

Attach Support Leg(M) to Center Support Rail(L) using Bolts(②) with Allen Key(⑤).

Step 8

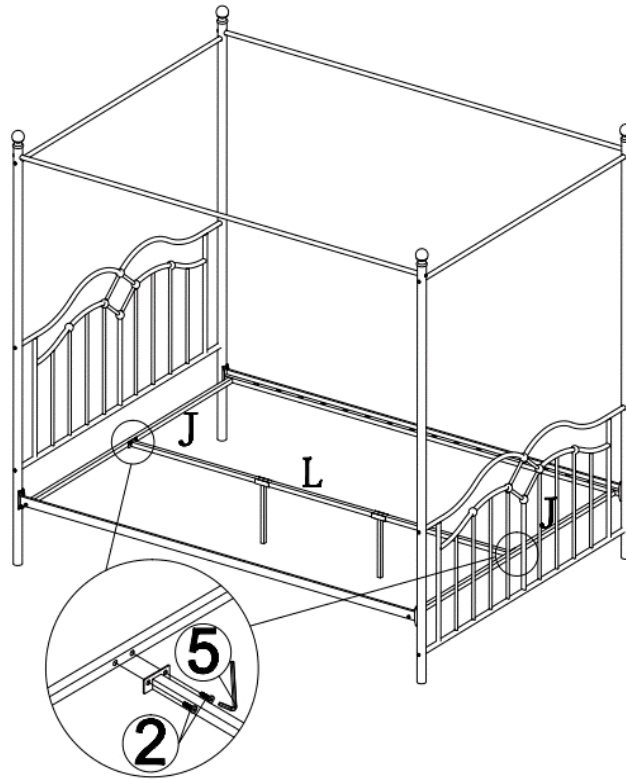

Turn over the assembled Center Support Rail(L&M).
Attach assembled Center Support Rail(L&M) to Support Rail(J) using Bolts(②) with Allen Key(⑤).

Step 9

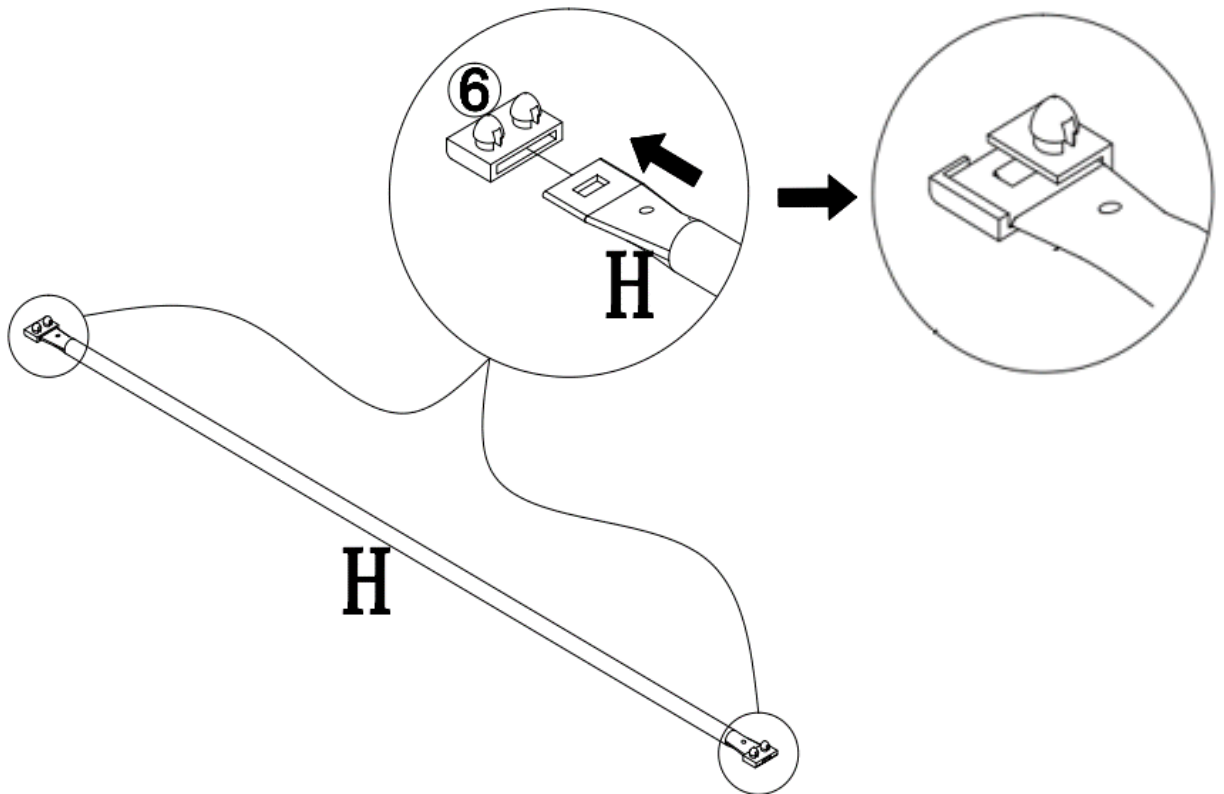

Insert Slat Connectors(⑥) into both sides of Slat(H) as pictured above.

Step 10

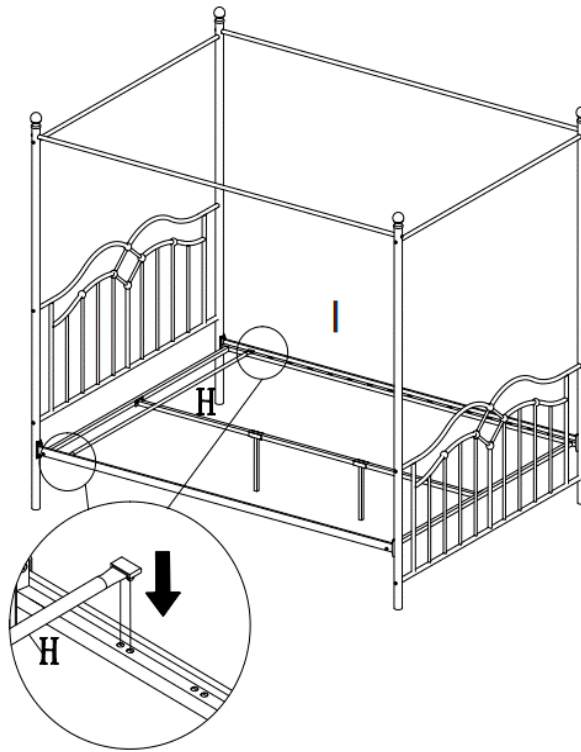

Attach assembled Slat(H) to the mounting position of Side Rail(I).
Repeat the same step to assemble remaining Slat.

Note: Before assembling Slat(H) to Side Rail(I), fully and securely, tighten all nuts, at all joints.

Inspect it and make sure all parts are adequately connected.

Step 11

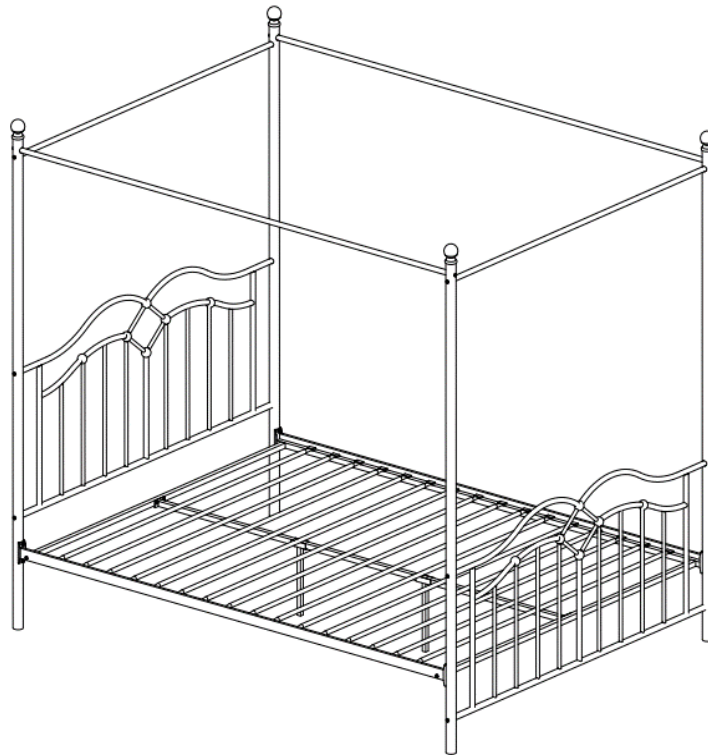











Fully and securely, tighten all nuts, at all joints.

Inspect it and make sure all parts are adequately connected.

Your bed is ready for use.

Caution: This Bed can only be used on a flat, level surface.

Care & Maintenance

-  Do not put hot items directly on furniture surface
 -  Do not clean furniture with harsh cleansers or polish.
 -  Do not place furniture under direct sunlight.
 -  Do not place furniture near heating or cooling vents.
 -  Do not write on furniture without a padded barrier to protect the surface.
 -  Do not place furniture outside . For indoor use only .
 -  Not for commercial use. For residential use only .
 -  Stains may be removed with mild soap solution and damp cloth.
 -  Children should not climb or jump on the furniture.
-
-  Dust and pick-up spills using a clean, non-colored, lint-free cloth .