

Thank you for choosing our Partition Desks!

To prevent damage and loss during transportation, we have included ****extra small Privacy Panels and hardware components**** in your package. Please check the contents carefully before assembly. Please do not be alarmed if there are any leftover parts after assembly-these are the spare components we prepared in advance. If you are satisfied with your Desk and our service, a positive review would be greatly appreciated!





Installation personnel: 2 people

****Due to the heavy weight of the product, it is not easy to move after installation. To avoid any inconvenience, please assemble it after confirming the placement location.**

List Of Parts

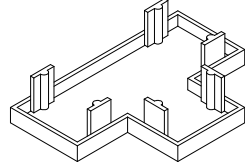
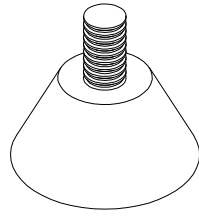
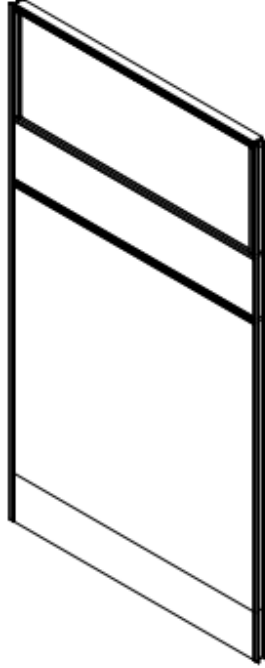
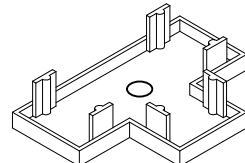
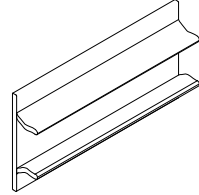
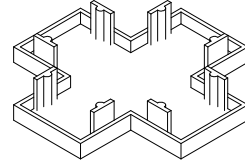
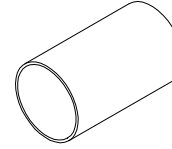
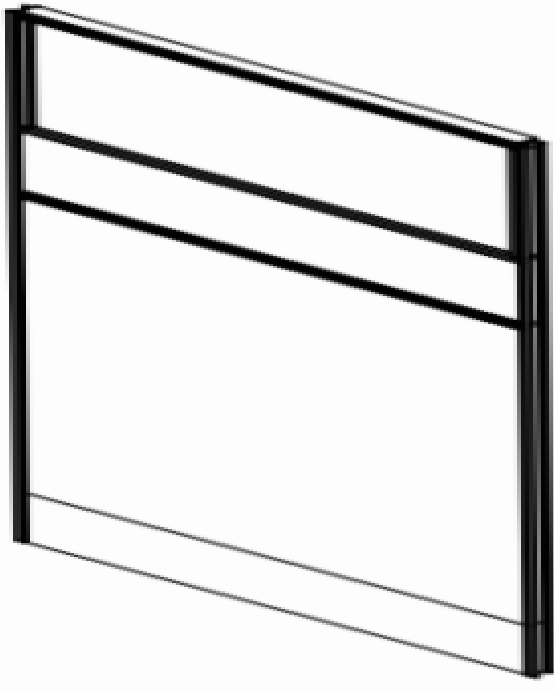
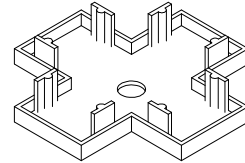
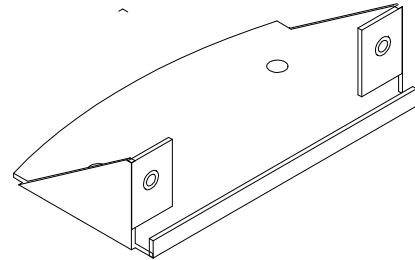
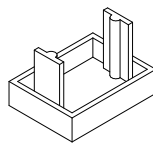
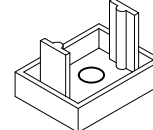
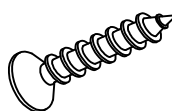
*It includes two hardware packages. The extra parts in the second package serve as backup parts.

<p>T-shaped interface  X2</p>	<p>Adjustable foot  X9</p>	<p>Privacy panel (small) * 8</p> <p>6 for install 2 spare vsshipping damage</p> 
<p>T-joint  X2</p>	<p>Side banding  X6</p>	
<p>Cross joint  X1</p>	<p>Cylindrical tube  X3</p>	<p>Privacy panel (Big) * 2</p> 
<p>Cross foot  X1</p>	<p>corbel  X24</p>	
<p>Side joint  X6</p>		
<p>pleurocrus  X6</p>	<p>Self-tapping yarn  X48</p>	<p>Desktop* 4 </p>

Installation guide

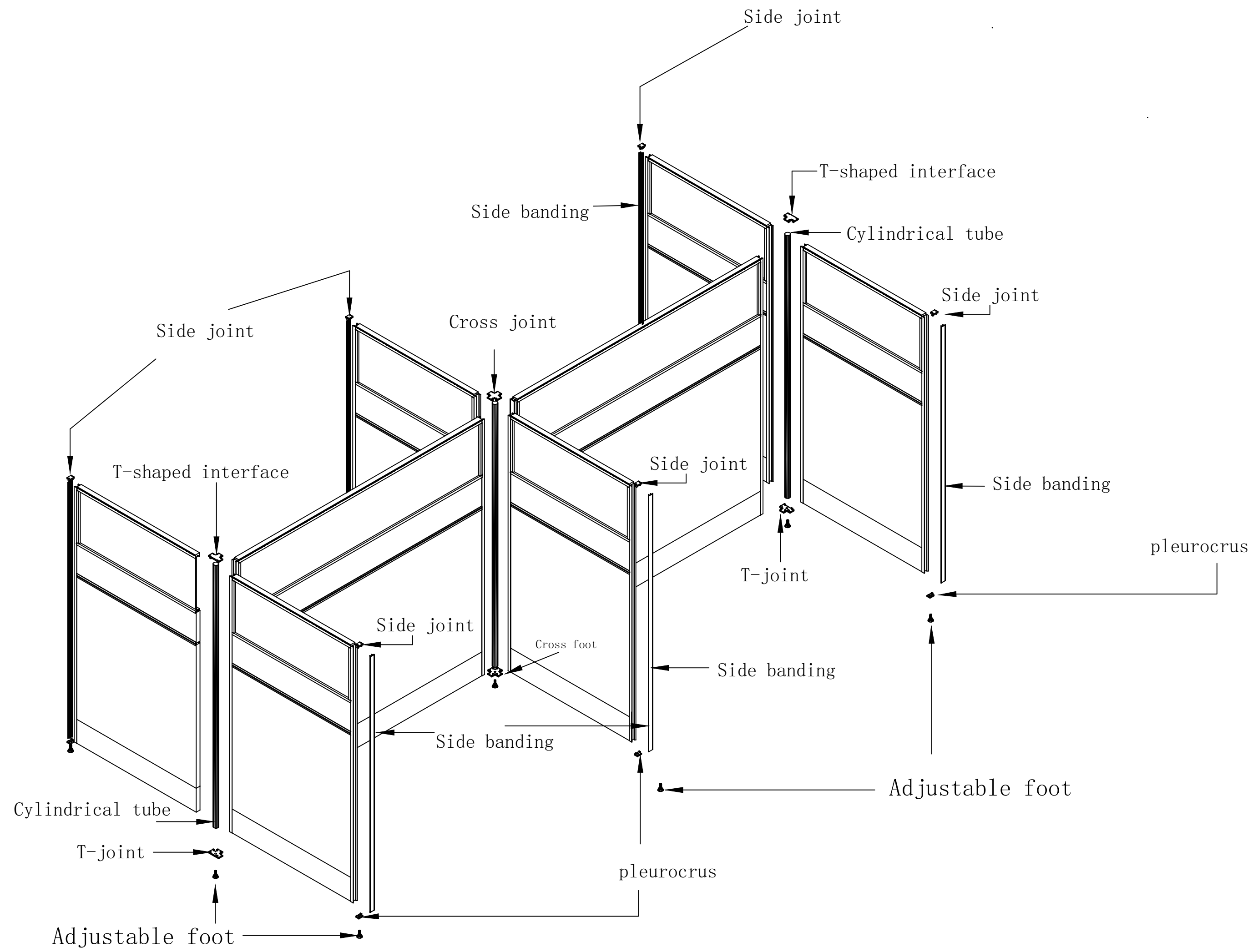

Step 1

Step 2

The bracket arm is adjusted and fixed on the screen plate with self-tapping.

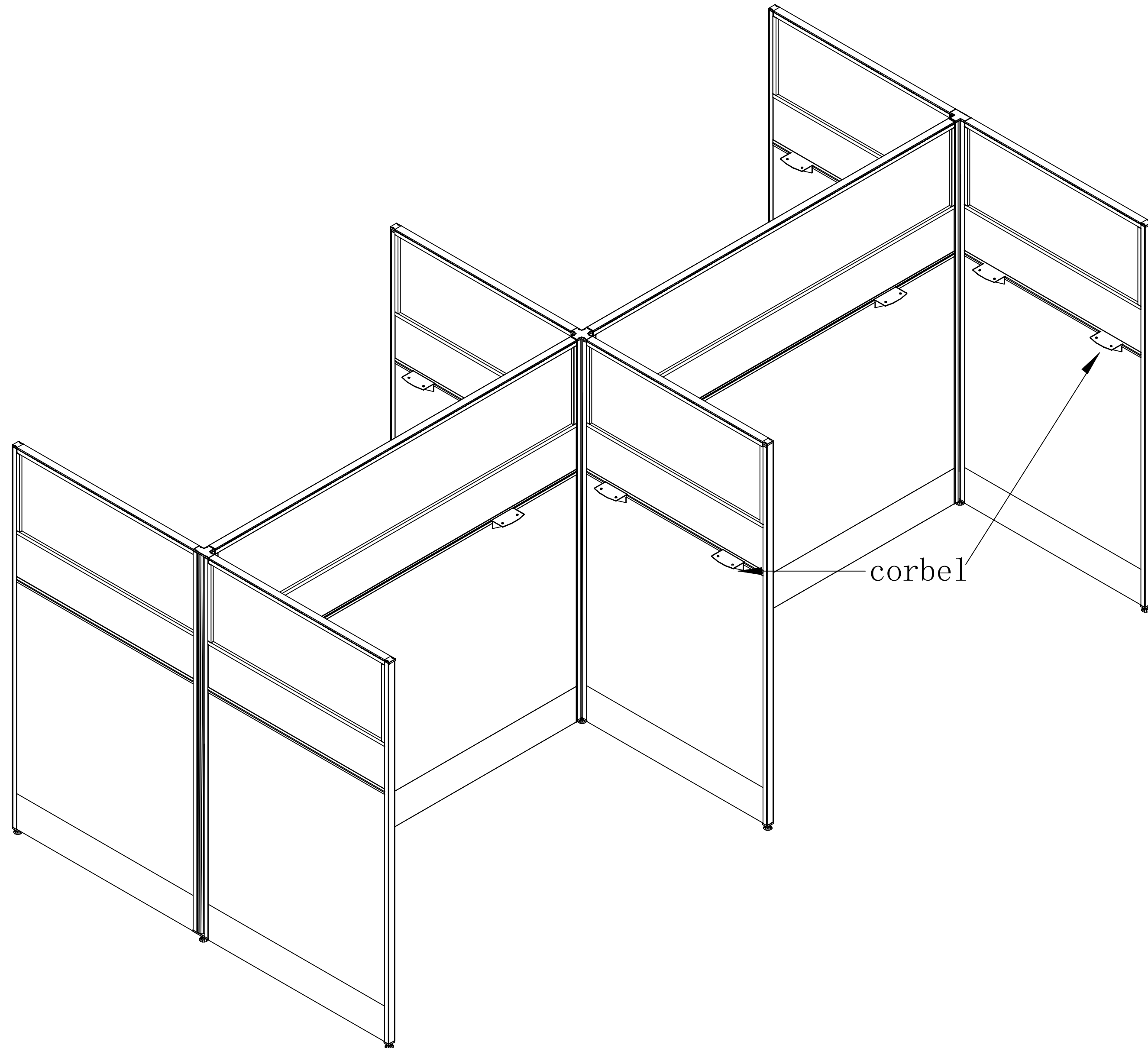

Step 3

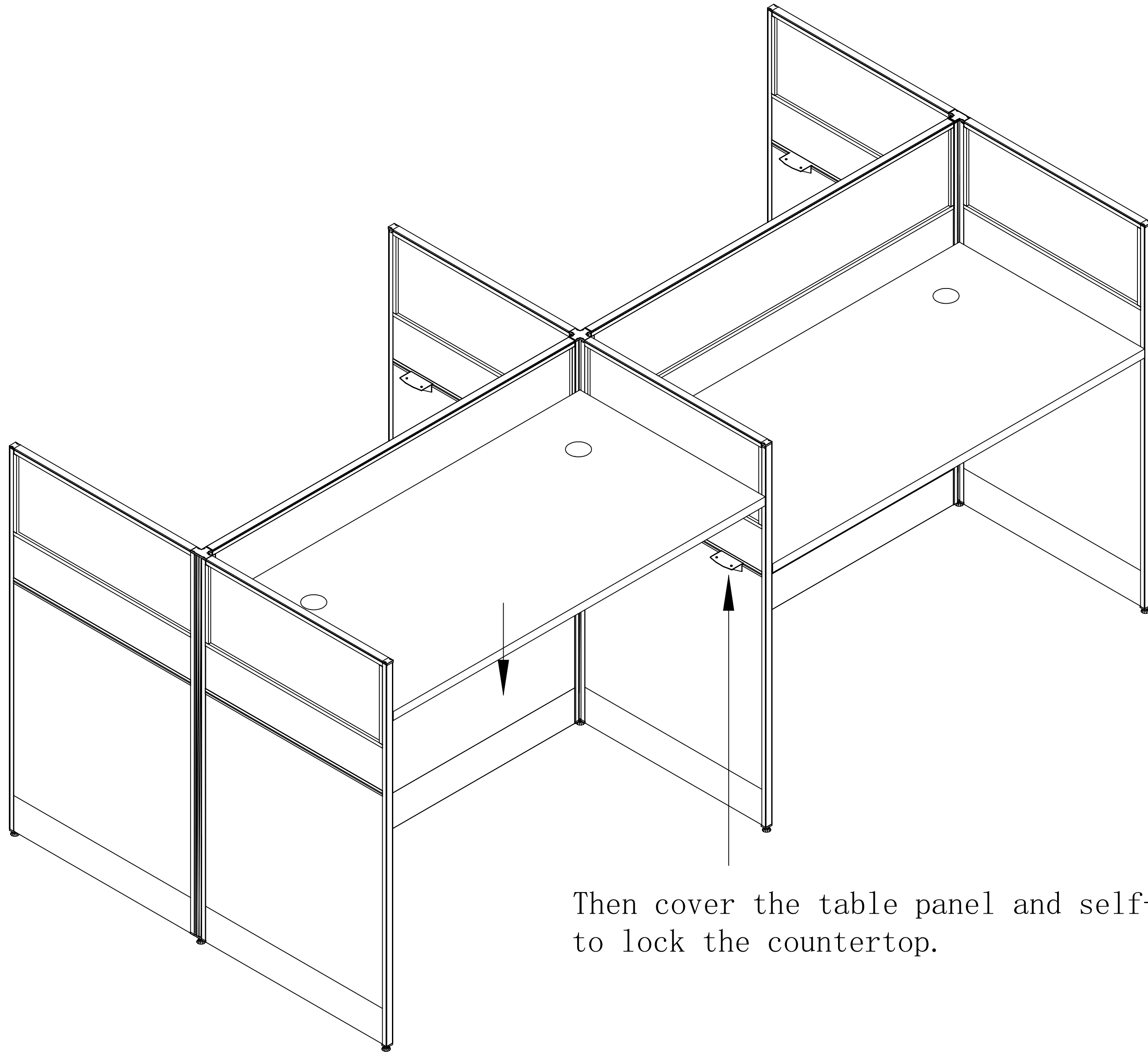

Then cover the table panel and self-tapping screws to lock the countertop.