

# Chair Assembly Instructions

Estimated Assembly Time in Minutes

☆ <15   ★ <45   ☆ 60+



Your chair comes packaged in one box.

**DO NOT** use any sharp objects to open plastic wrapped components as damage to product or components may result.

Carefully remove all of the components from the packaging and set aside for assembly. Assemble on a soft surface to prevent scratching the finish.

## Parts List

**A** 1 x Back



**B** 1 x Left Arm

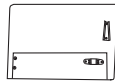

**C** 1 x Right Arm

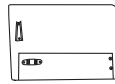

**D** 1 x Seat Deck

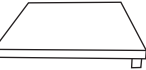

**E** 1 x Front Rail

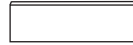

**F** 1 x Seat Cushion

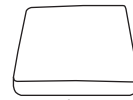

\* **G** 2 x Front Legs



\* **H** 2 x Back Legs



\* **I** 4 x Washers



## Hardware List

\* **J** 4 x Bolts (pre-installed) M6 x 25mm



\* **K** 1 x Hex Key M5 x 110mm

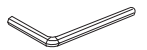

\* Replaceable Parts

## Assembly

Step 1

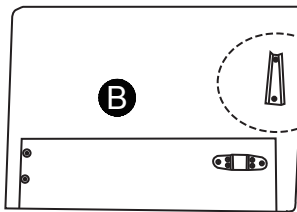

Remove protective cover

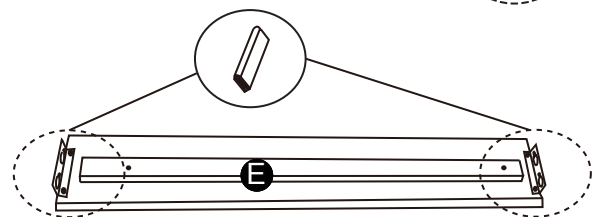
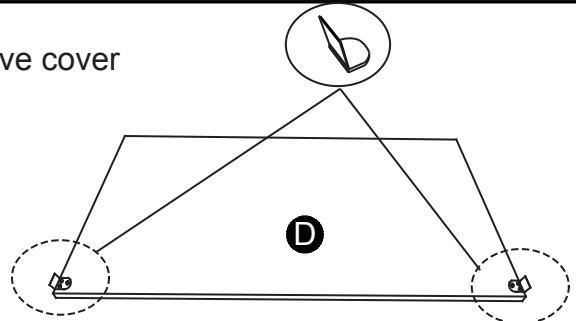
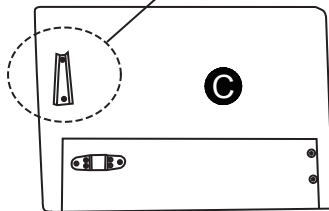

Step 2

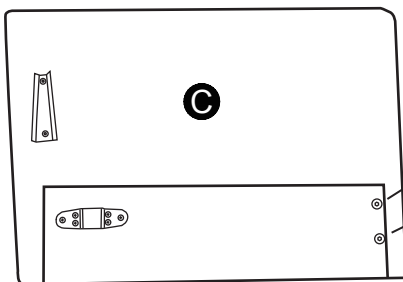

Loosen bolts

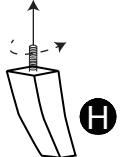
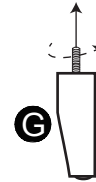
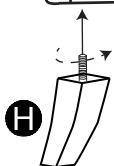
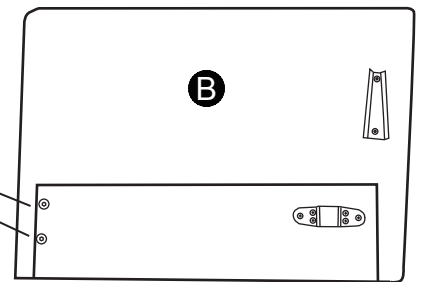
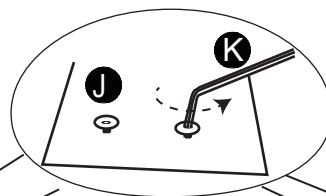

# Assembly

## Step 3

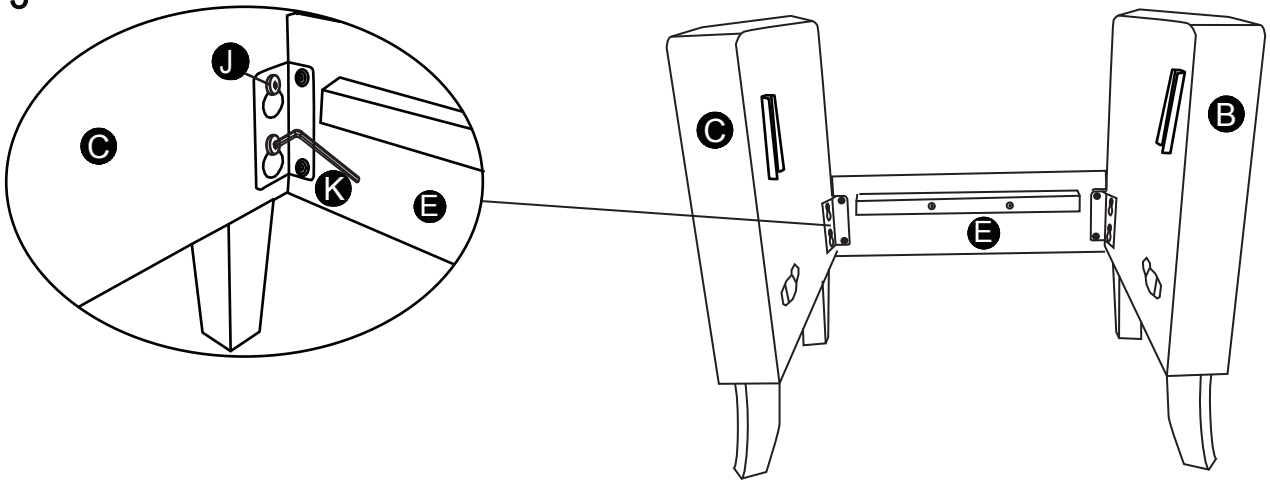

## Step 4

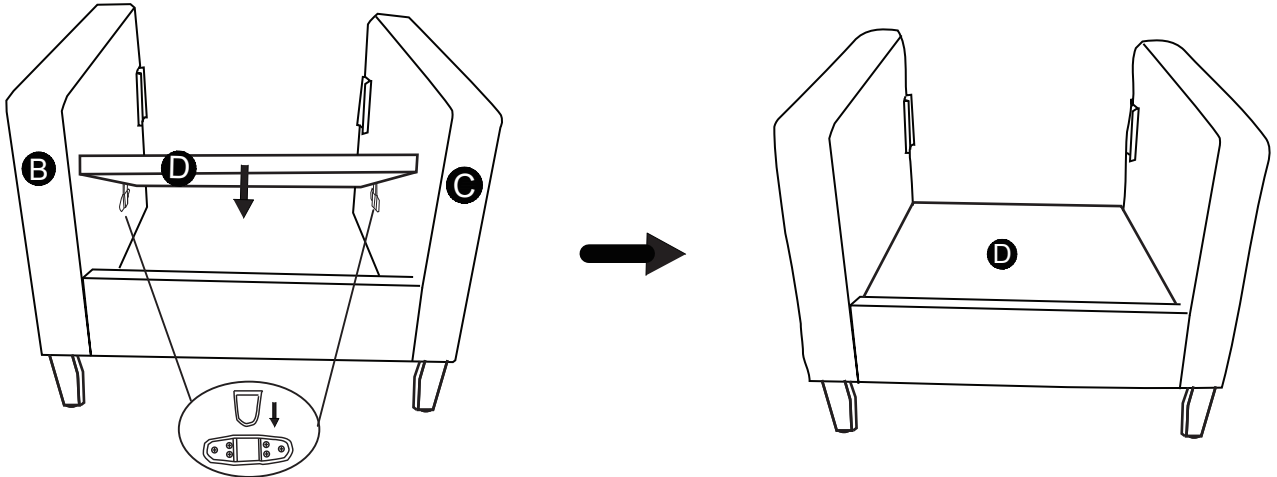

## Step 5

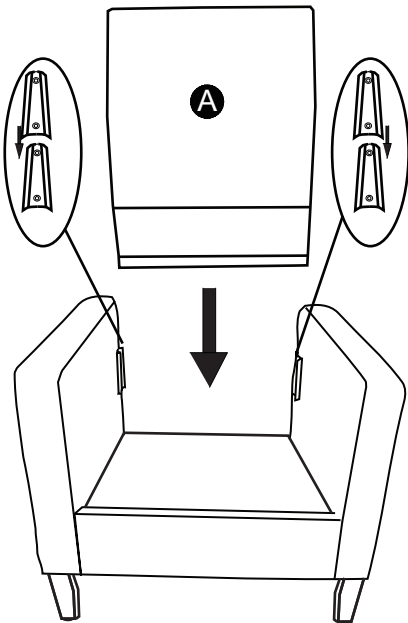

## Step 6

Remove the protective fabric from the seat cushion and seat deck.

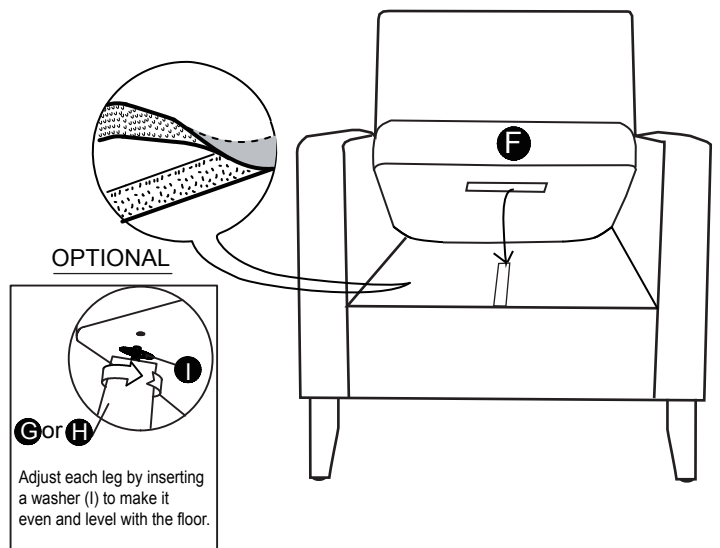

Your style may differ from images. Care for your furniture by periodically tightening all legs and periodically tightening all bolts using the included hex key.

About your furniture piece:

- Softening of foam is natural and will happen over time with use.
- Fabric will fade or discolor in direct sunlight. Minimize exposure to direct sunlight to extend the life of your furniture.
- Wood grain, knots, streaks, and color variation occur naturally in wood and are not considered defects.

**CAUTION:** Tighten all components securely before use. Failure to do so may result in personal injury.