

MANUAL BOOK

USE AND CARE GUIDE

CRYSTAL CHANDELIER LIGHT



USE AND CARE GUIDE

CRYSTAL CHANDELIER LIGHT

Safety Information

- To reduce the risk of electric shock, the electricity has been turned off at the circuit breaker or fuse box before begin.
- All wiring must be in accordance with the National Electrical Code NASI/NFPA 70- 1999 and local electrical codes Electrical installion should be performed by a qualified licensed electrician.
- The outlet box and bracket support structure must be securely mounted and capable of reliably supporting 66lb. (30kg) or more.
- The Chandelier must be mounted with a minimum of 7 ft. (2m) clearance from the ceiling edge of the to the floor.
- The chandelier has its own dimmer and cannot be used together with your own dimmer (to avoid short circuit).
- Do not place objects in the path of the Fixtures.
- To avoid personal injury or damage to the chandelier and other items, please be careful when working around or cleaning the chandelier.
- Electrical diagrams are for reference only. Light kits that are not packed with the chandelier must be UL - Test Report, and marked suitable for use with the model chandelier that you are installing. Switches must be UL General Use Switches. Refer to the instructions packaged with the light kits and switches for proper assembly.
- After making electrical connections, spliced ??conductors should be turned upward and pushed carefully up into the outlet box. The wires should be spread apart with the grounded conductor and the equipment-grounding conductor on one side of the outlet box.
- All setscrews must be checked and retightened where necessary before installation.

WARNING: To avoid the risk of personal injury, BRACKET is necessary to support the chandelier when installing large chandelier.

WARNING: To avoid the risk of fire or electric or shock, do not use this fixtures with any solid-state speed control device.

WARNING: To avoid possible electric shock turn the electricity off at the main fuse box before wiring. If you feel you do not have enough electrical wiring knowledge or experience, contact a licensed electrician.

WARNING: Electrical diagrams are for reference only. Optional use of any light kit shall be UL - Test Report and marked suitable for use with this Fixtures.

WARNING: To avoid the risk of fire, electric shock or personal injury, mount to outlet box marked "Acceptable for fixtures support of 66lbs. (30 kg) or more" and use the screws provided with the outlet box.

Regular Switch

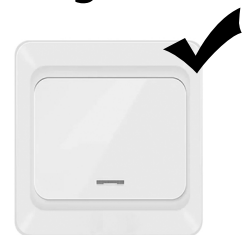

Dimmer Switch



Remote control manual

Remote control manual

Basic operation instructions:

- Code alignment: The remote control can only be used after code alignment operation with the driver. The method is as follows: After connecting the driver to the load lamp (light source) and the power supply, switch on the power supply. At the moment of switching on the power supply (see Press (ON) within 3 seconds after the light/light source is on. When you see that the light (light source) will "flash three times slowly", that is, the code and grouping is successful.
- Clear the code, the method is as follows: select the lamp that needs to clear the code, cut off the power, reconnect the power, after connecting the power light (Within 3 seconds), press the main open button five times, that is, the lamp/light source will "flash six times", to confirm the success of code clearing.

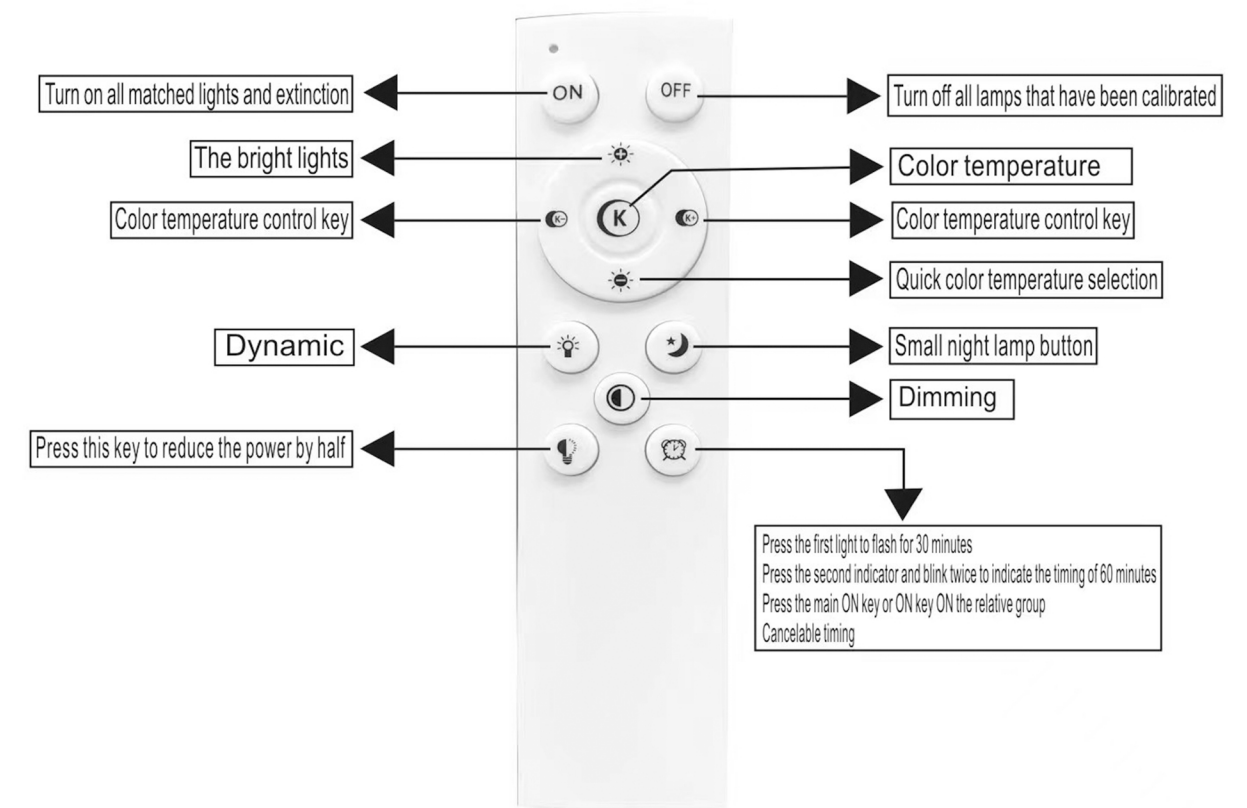

STEP 4: Connect wires and install the canopy.

Remove protective film on the canopy and chandelier base.

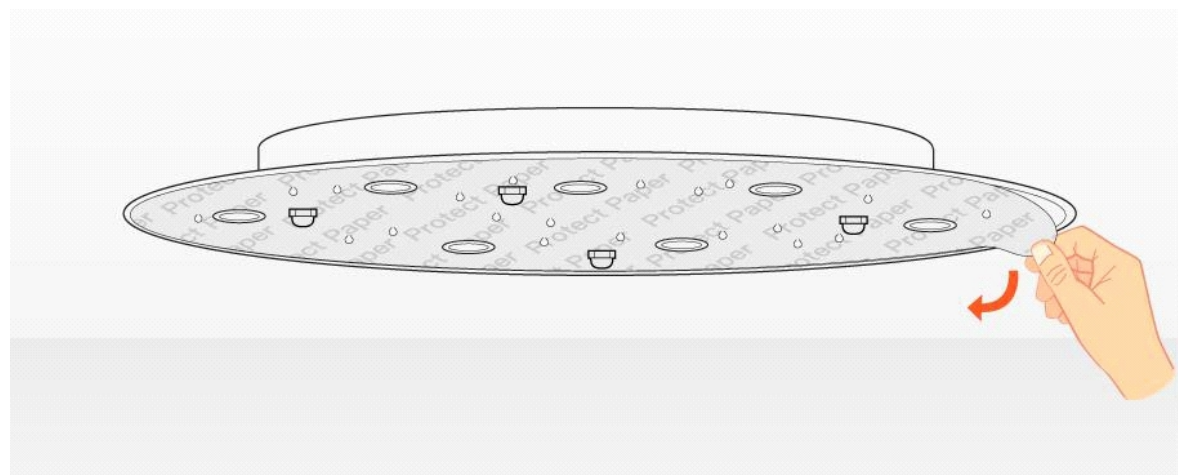

Installation steps

Step 5. Buckle the wire at one end of the crystal into the steel ring.

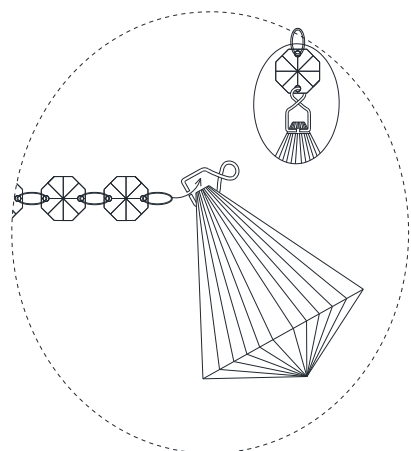

Installation steps

Step 6. Hang the crystal beads on the lamp body.

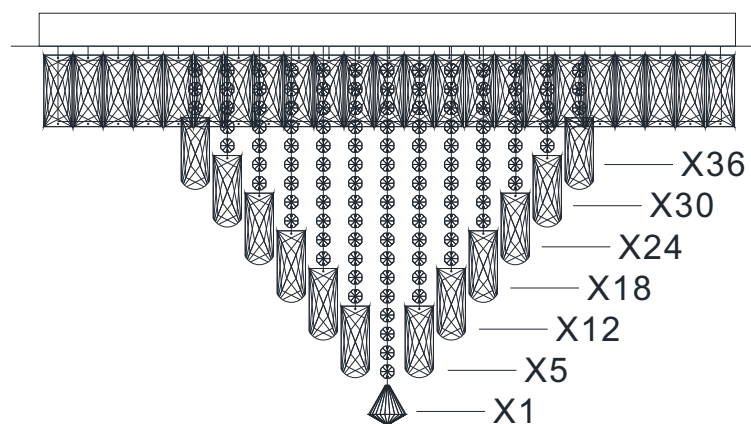

Warranty

All of the fixtures parts are free from defects in workmanship and material at the time of shipment from the factory. For a period of 5 years after the date of purchase by the original purchaser, we agree to correct any our defects without charge or at our option replace with a comparable or superior model if the product is returned. To obtain warranty service, you must present a copy of the receipt as proof of purchase. All costs of removing and reinstalling the product are your responsibility. Damage to any part, such as by accident misuse, improper is not covered by this warranty. Because of varying climatic conditions this warranty does not cover any changes in metal finished, including rusting/pitting/corroding/tarnishing/peeling. Metal finished of this type give their longest useful life when protected from varying weather conditions. A certain amount of "wobble" is normal and should not be considered a defect. Servicing performed by unauthorized persons shall render the warranty invalid. There is no other express warranty. hereby di sclaims any and all warranties, including but not limited to those of merchantability and fitness for a particular purpose to the extent permitted by law. The duration of any implied warranty which cannot be disclaimed is limited to the time period as specified in the express warranty. Some states do not allow a limitation on how long an implied warranty lasts, so the above limitation may not apply to you. The retailer shall not be liable for incidental, consequential, or special damages arising out of or in connect ion with product use or performance except as may otherwise be accorded by law. Some states do not allow the exclusion of incidental or consequential damages, so the above exclusion or limitation may not apply to you. This warranty gives specific legal rights, and you may also have other rights which vary from state to state. This warranty supersedes all prior warranties. Shipping costs fro any return of products as part of a claim on the warranty must be paid by the customer.

Pre-Installation

SPECIFICATION

| Size | AC | Including LED bulb | Dinmingrange | Remote control | chandelier net weight | chandelier packaging size |
|------|----------|--------------------|--------------|----------------|-----------------------|---------------------------|
| 24in | 85V-256V | 68W | 3000K-6000K | Include | 11.5KG | 70*70*21 |
| 32in | 85V-256V | 100W | 3000K-6000K | Include | 18.8KG | 90*90*21 |
| 40in | 85V-256V | 150W | 3000K-6000K | Include | 24.5KG | 110*110*21 |

The above data are for reference only ,Actually the Size power or each fixtures is a little different ,Any products ,Subject to actual products as standard

NOTE: These are approximate measures. They do not include the amps and wattage used by the light kit.

Specifications & measurements shown are subject to ±5% variations.

TOOLS REQUIRED



Parts list

Open the package and check the contents. You should have the following conditions:

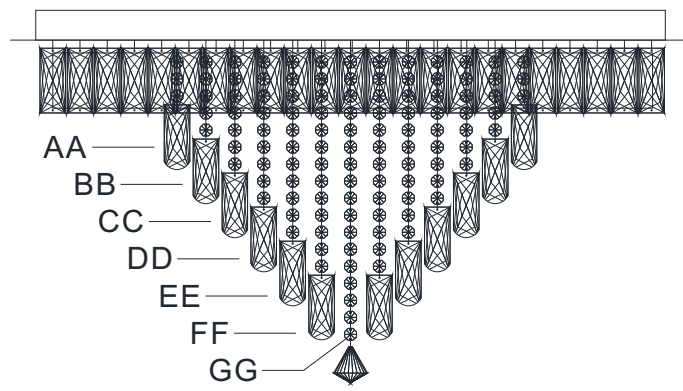
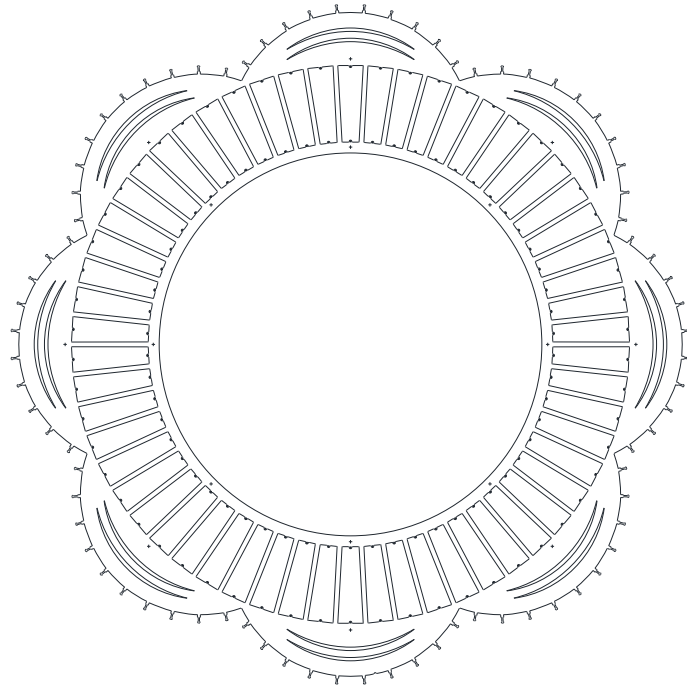
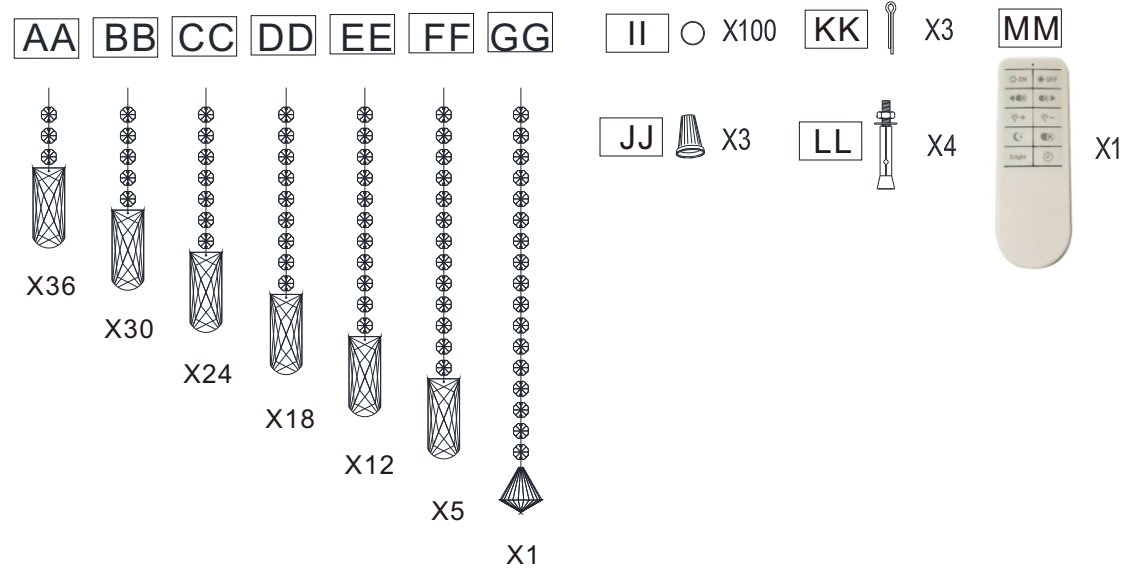

Installation steps

Step 1. Turn off the electricity supply at the main circuit panel before installing. Do not connect the electricity supply until your luminaire is fully assembled and installed. Fix the hanging plate on the ceiling.

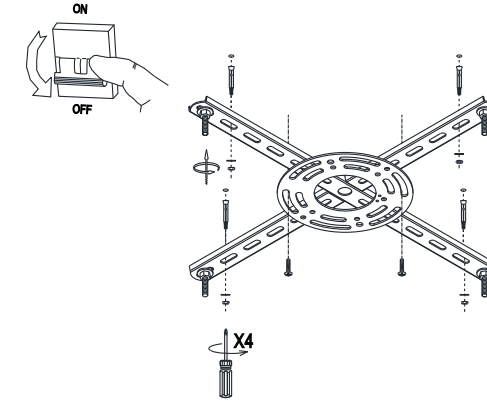

Installation steps

Step 2.

1. The motor "green" wire to the "Ground wire" wire from outside Outlet Box.
2. The motor "white" wire to the "AC IN <N>" wire from outside Outlet Box.
3. The motor "black" wire to the AC IN <L>" wire from outside Outlet B
4. Finally, put the connected wires in the hanger.

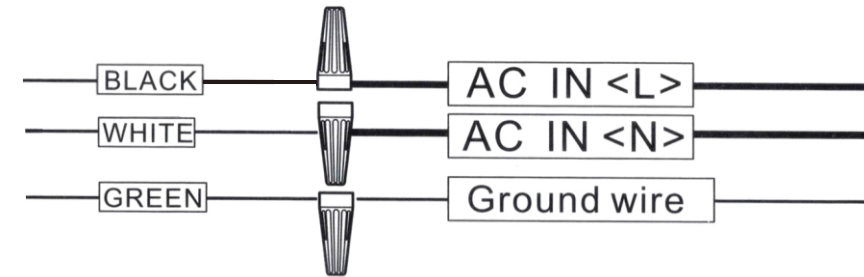

Installation steps

Step 3. Fix the nut knob tightly to the sucker.

