

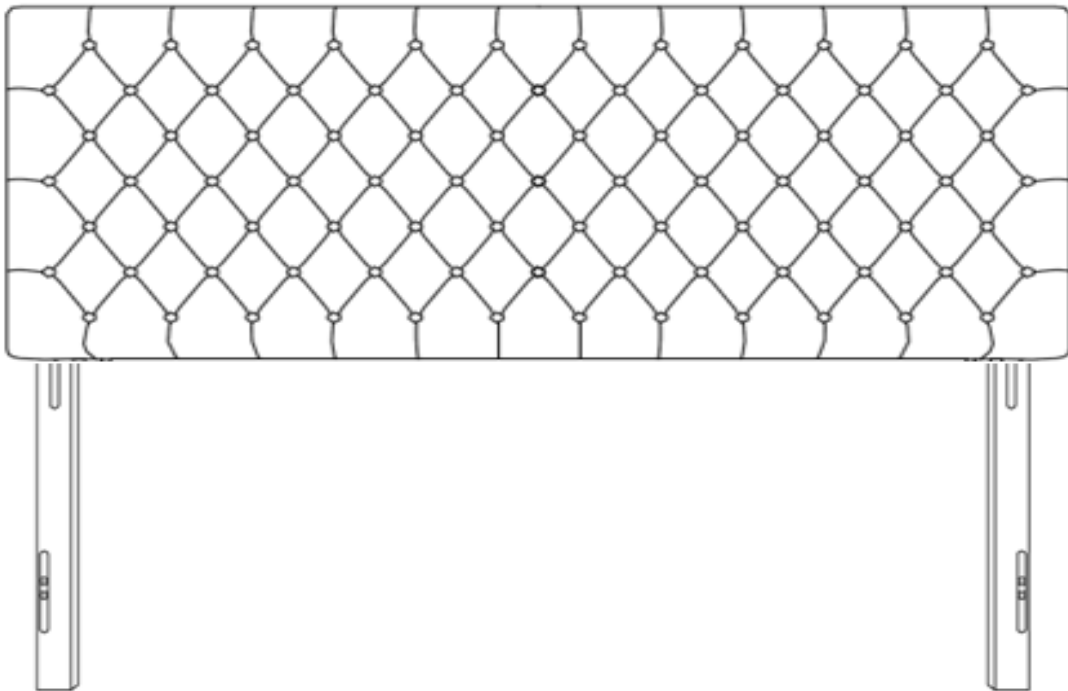

Assembly Instructions

Caution : You must read this before you proceed. This headboard must be used in conjunction with a Mattress Support Frame (not included and not supplied with this headboard.)



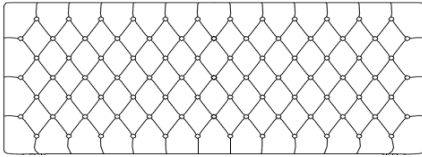

Headboard



Parts List

Part NO.	Picture	Description	Qty
A		Headboard	1 PC
B		Left Support Leg with 3 Mounting Brackets (With the sticker "Left" on the bottom)	1 PC
C		Right Support Leg with 3 Mounting Brackets (With the sticker "Right" on the bottom)	1 PC

Hardware

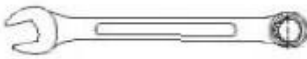
Label	Picture	Description	Qty
a		Bolt M8X25mm	9 PCS
b		Spring Washer Ring	9PCS
c		Flat Washer Ring	9PCS
d		Nut Cap	5 PCS
e		Allen Key	1 PC
f		Solid Wrench	1 PC

Assembly Preparation

Before Beginning Assembly:

Unpack and place all parts for clear visibility.

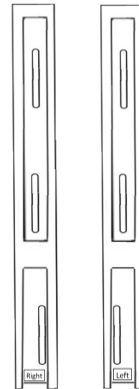
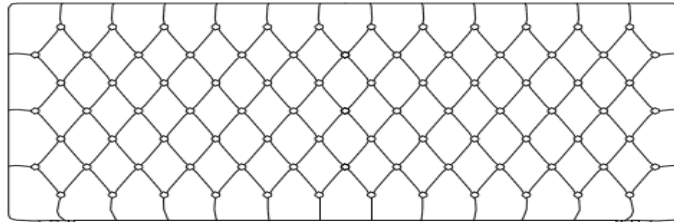

Pack A: For assembly the legs to the headboard

4 Bolts (a) + 4 Flat Washers (c) + 4 Spring Washers (b) with the Allen key.

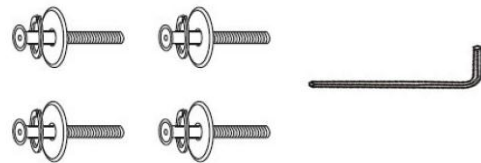

Pack B: For assembly the legs to the bed frame

4pcs M8X25mm bolts(a)+ 4pcs of Flat Washer Ring(c) + 4pcs Spring Washer Ring(b)+4pcs Nut Cap(d) with a Solid Wrench(f).

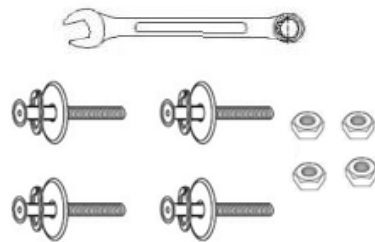

- Read instructions, cover to cover-



- Have 2 adults on hand for assembly-



- Do not assemble on flooring or carpet-



- Assemble on a clean non-marring surface (packing foam)-



- Save all packaging until finished-

Assembly Steps

Step 1

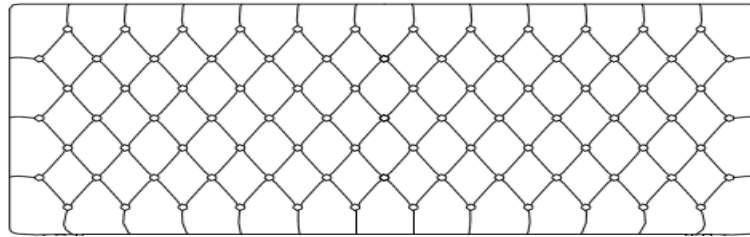

Headboard

Place the Headboard (A) on a soft surface to avoid any scratches on the products.

Take out the 2 legs and the package of hardware accessories.

Step 2

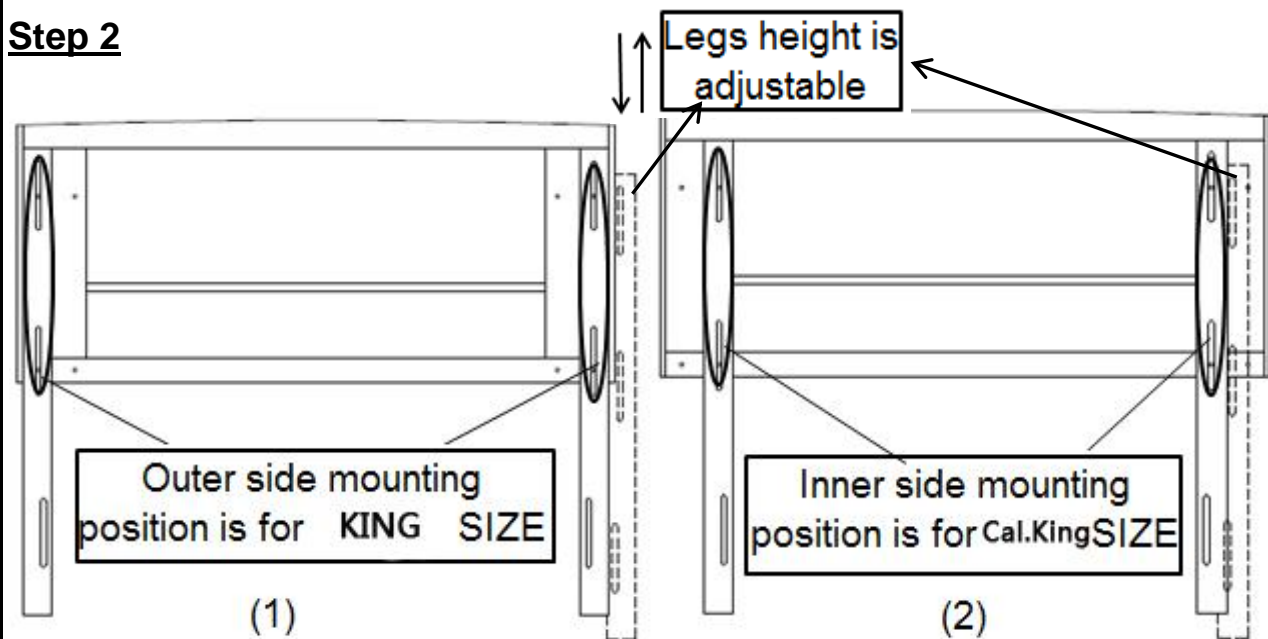

Put the Headboard(A) onto a flat table or panel.

Align the mounting position on Headboard(A) to the mounting position on Left Support Leg(B).

Then, lock the top and the middle mounting positions(use Pack A).

Repeat the same steps to install the Right Support Leg(C).

The hardware for these are: 4 Bolts (a) +4 Flat Washers (c) + 4 Spring Washers (b) with the Allen key(e).

King size assembly as picture (1) show; Cal.King size assembly as picture (2) show;

At this point of assembly, **DO NOT overfasten the connections.**

The final height of the Headboard may be adjusted to your own need.

Step 3

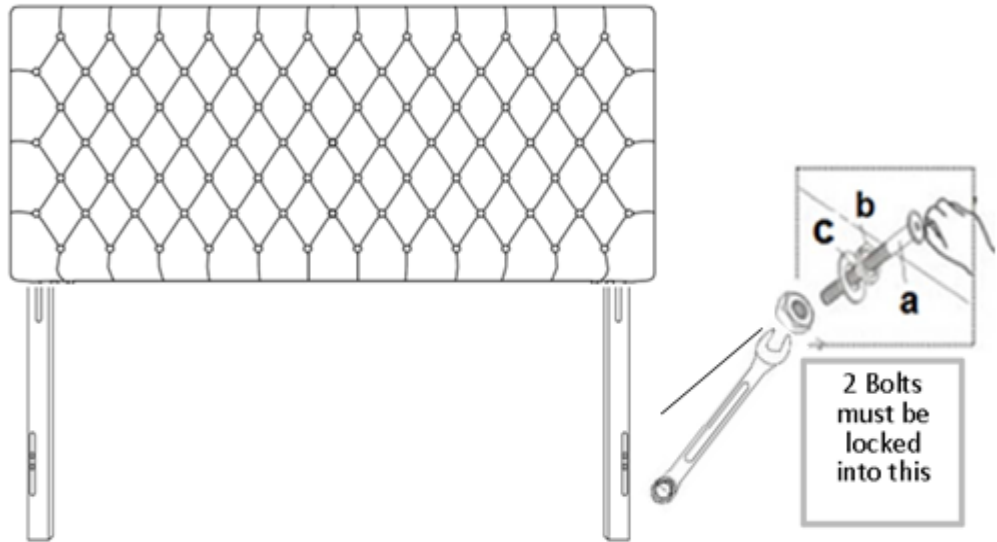





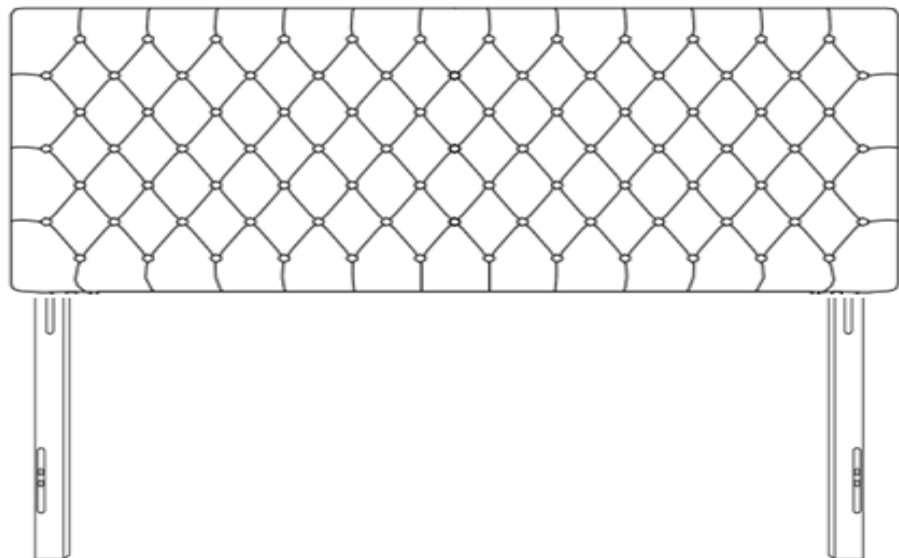

Next, hold the Headboard upright and align to the Headboard bottom mounting bracket to the Mattress Support Frame mounting bracket. Affix the Headboard to the Mattress Support Frame using Pack B. Please install the bolts from the FRONT TO BACK of the headboard. The hardware for these are: 4pcs M8X25mm bolts(a)+ 4pcs of Flat Washer Ring(c) + 4pcs Spring Washer Ring(b)+4pcs Nut Cap(d) with a Solid Wrench(f).

Step 4



Make sure all parts are connected and securely locked into position. Your headboard is ready for use.

Care & Maintenance

-  Do not put hot items directly on furniture surface
 -  Do not clean furniture with harsh cleansers or polish.
 -  Do not place furniture under direct sunlight.
 -  Do not place furniture near heating or cooling vents.
 -  Do not write on furniture without a padded barrier to protect the surface.
 -  Do not place furniture outside . For indoor use only .
 -  Not for commercial use. For residential use only .
 -  Stains may be removed with mild soap solution and damp cloth.
 -  Children should not climb or jump on the furniture.
-
-  Dust and pick-up spills using a clean, non-colored, lint-free cloth .