





# ASSEMBLY INSTRUCTION

## Note:

1. Before fixing all screws, tighten each screw to 50% using an Allen wrench instead of an electric drill. If any screws are fully tightened during assembly, it is likely that the others will not align with their respective holes. Additionally, the holes are intentionally designed to be relatively larger to allow for adjustment of the screws.
2. Place the item on a flat surface to ensure stability during adjustment.
3. Gradually tighten all screws using appropriate tools.
4. If screws are not aligned with their respective holes during assembly, loosen all other screws to 50% and then continue the assembly process.
5. If the item is unstable, loosen all screws, adjust it on a flat surface, and then retighten all screws.

## Hardware Fittings

Item No.	Reference Image	Description	Qty.	Extra Spare Parts Qty.
A		screw M6*25	12	1
B		washer M6	12	1
C		allen key M6	1	1
D		Adjustable foot pads	4	1
E				
F				

Item No.	Reference Image	Description	Qty.	Extra Spare Parts Qty.
G				
H				
I				
J				
K				
L				

## Step1



## Step2

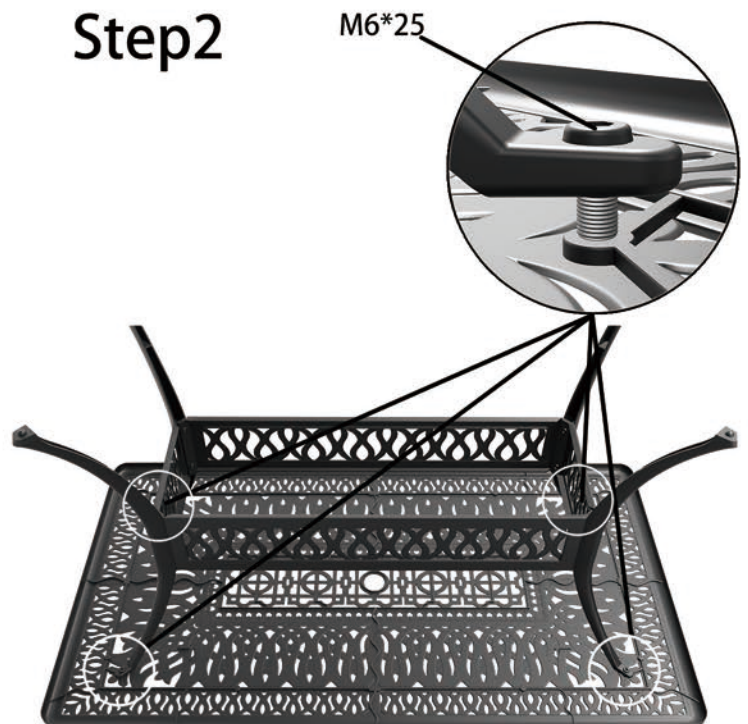



# ASSEMBLY INSTRUCTION

## Note:

1. Before fixing all screws, tighten each screw to 50% using an Allen wrench instead of an electric drill. If any screws are fully tightened during assembly, it is likely that the others will not align with their respective holes. Additionally, the holes are intentionally designed to be relatively larger to allow for adjustment of the screws.
2. Place the item on a flat surface to ensure stability during adjustment.
3. Gradually tighten all screws using appropriate tools.
4. If screws are not aligned with their respective holes during assembly, loosen all other screws to 50% and then continue the assembly process.
5. If the item is unstable, loosen all screws, adjust it on a flat surface, and then retighten all screws.

## Hardware Fittings

Item No.	Reference Image	Description	Qty.	Extra Spare Parts Qty.
A		screw M6*16	20	1
B		washer M6	20	1

Item No.	Reference Image	Description	Qty.	Extra Spare Parts Qty.
C		allen key M6	1	1
D		foot pads	4	1

### Step1

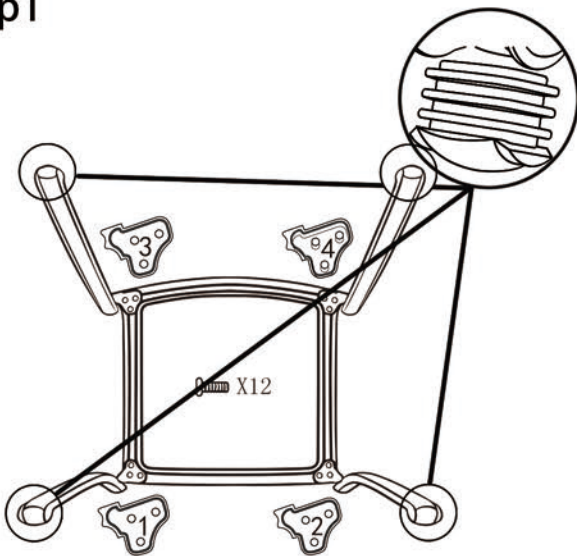

### Step2

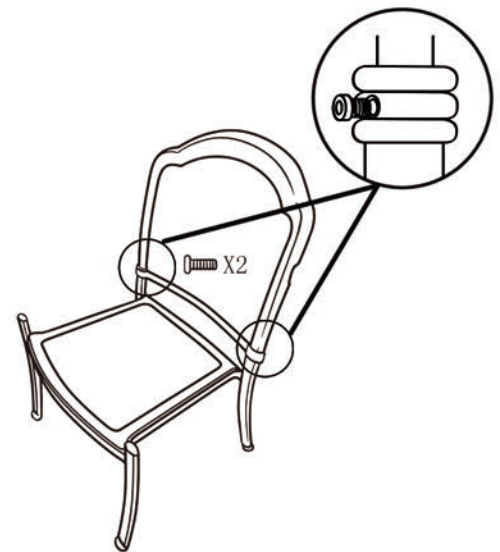

### Step3

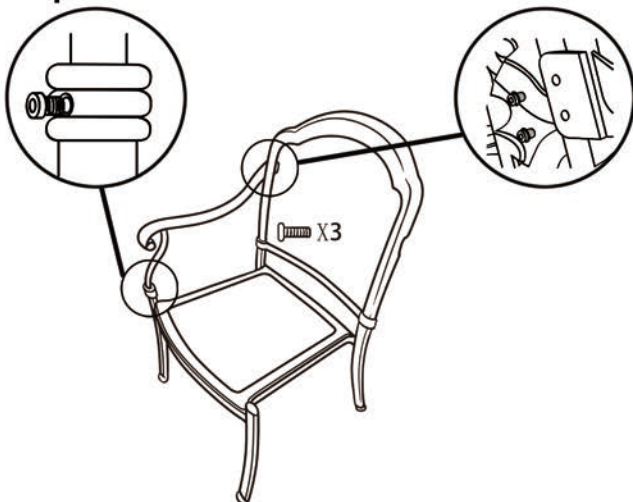

### Step4

