

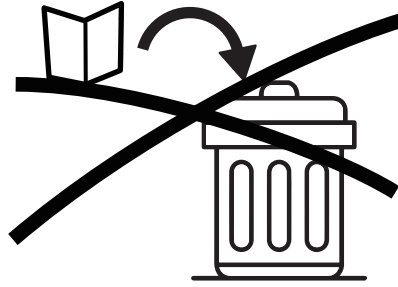

ASSEMBLY INSTRUCTIONS

NOTICE

IMPORTANT, RETAIN FOR FUTURE REFERENCE: READ CAREFULLY
WICHTIG, FÜR SPÄTERE NACHSCHLAGE AUFBEWAHREN: SORGFÄLTIG LESEN
IMPORTANTE, GUARDAR PARA REFERENCIA FUTURA: LEER ATENTAMENTE
IMPORTANTE, CONSERVARE PER RIFERIMENTI FUTURI: LEGGERE ATTENTAMENTE
IMPORTANT, À CONSERVER POUR RÉFÉRENCE FUTURE : LIRE ATTENTIVEMENT

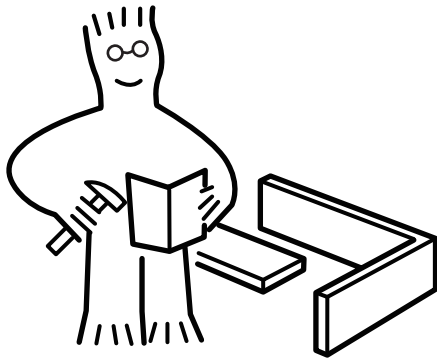

Assemble on a flat, clean and soft surface.
Auf einer flachen, sauberen und weichen Oberfläche zusammenbauen.
Assembler sur une surface plate, propre et douce.
Assemblare su una superficie piatta, pulita e morbida.
Ensamblar sobre una superficie plana, limpia y suave.

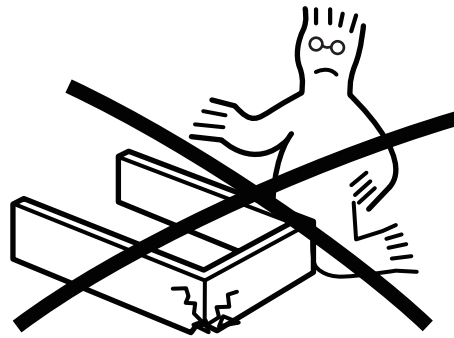
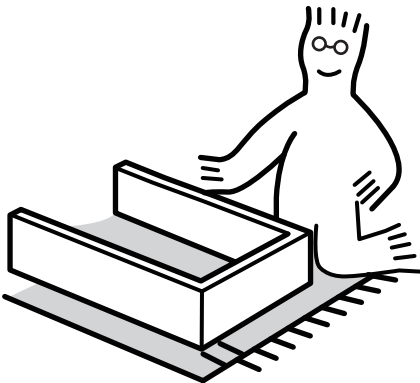

Professional installation is highly recommended.
Eine professionelle Installation wird dringend empfohlen.
Une installation professionnelle est fortement recommandée.
Si raccomanda vivamente l'installazione professionale.
Se recomienda altamente la instalación profesional.



Periodically Check That All Components Are Tightly Secured.
Überprüfen Sie Regelmäßig, Dass Alle Komponenten Fest Gesichert Sind.
Vérifiez Périodiquement Que Tous Les Composants Sont Bien Fixés.
Controllare Periodicamente Che Tutti I Componenti Siano Ben Fissati.
Verifique Periódicamente Que Todos Los Componentes Estén Bien Asegura-
dos.



It is recommended that multiple people assemble this product.

Es wird empfohlen, dass mehrere Personen dieses Produkt zusammenbauen.







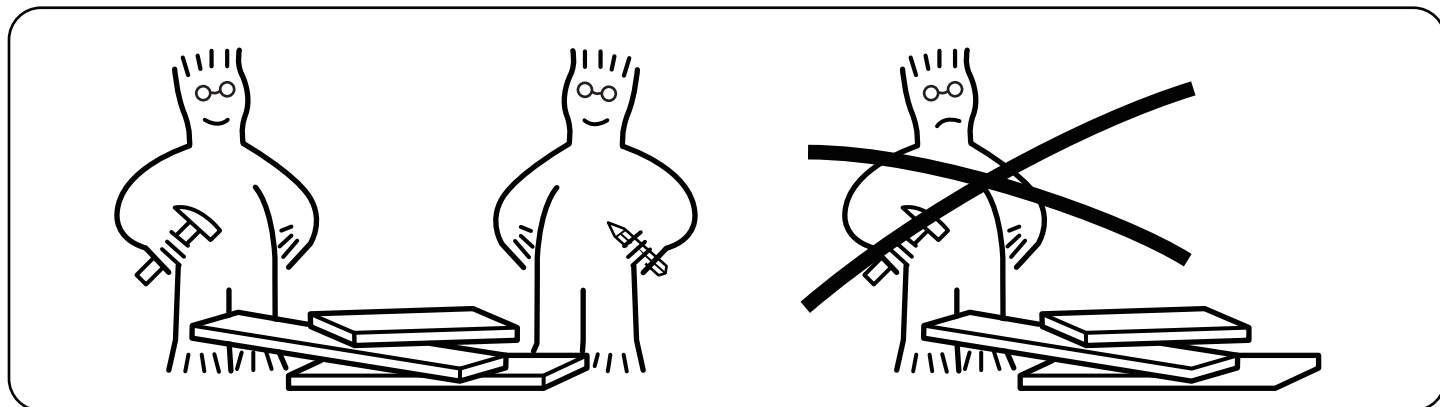





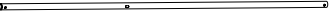

Il est recommandé que plusieurs personnes assemblent ce produit.



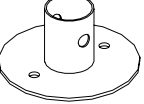

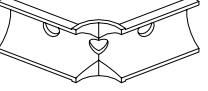
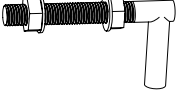
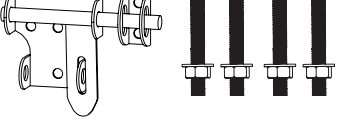
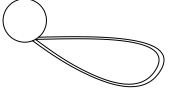

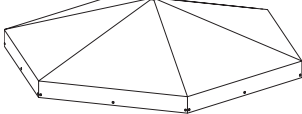
Si raccomanda che pi ù persone assemblino questo prodotto.

Se recomienda que varias personas ensamben este producto.

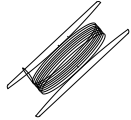

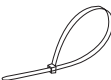
PARTS

Item no. Nr. N° d'article Articolo No. Artículo No.	Reference Image Referenzbild Image de référence Immagine di riferimento Imagen de referencia	Qty. Menge Qté. Qtà Cant.	Item no. Nr. N° d'article Articolo No. Artículo No.	Reference Image Referenzbild Image de référence Immagine di riferimento Imagen de referencia	Qty. Menge Qté. Qtà Cant.
8	 L:500mm	X2	11	 L:475mm	X2
12	 L:1470mm	X10	13	 L:1470mm	X2
14	 L:1510mm	X5	15	 L:1510mm	X1
16	 L:1435mm	X6	17	 L:1435mm	X1
18	 L:555mm	X2	19	 L:555mm	X2
A		X6	D		X12
E		X12	F		X4
G		X2	H		X12
J	 M6X45mm	X36	K		X1
L		X2	M		X1

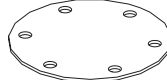
Item no. Nr. N° d'article Articolo No. Artículo No.	Reference Image Referenzbild Image de référence Immagine di riferimento Imagen de referencia	Qty. Menge Qté. Qtà Cant.	Item no. Nr. N° d'article Articolo No. Artículo No.	Reference Image Referenzbild Image de référence Immagine di riferimento Imagen de referencia	Qty. Menge Qté. Qtà Cant.
(N)	 30m	X1	(P)	 M6X40mm	X22
(Q)		X14	(R)		X6
(S)		X1	(T)		X2
(U)		X1	(V)		X1

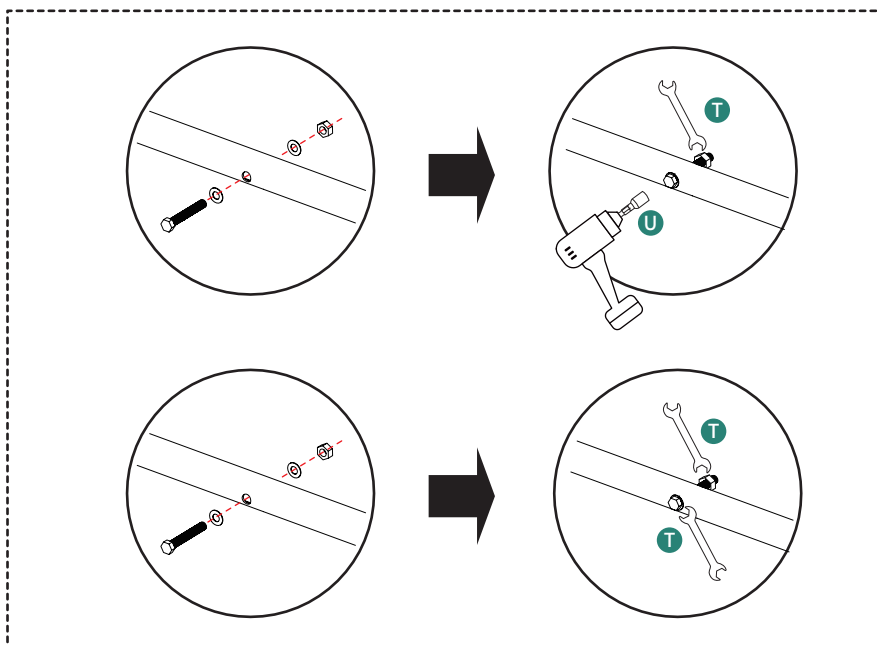

EXPLODED VIEW

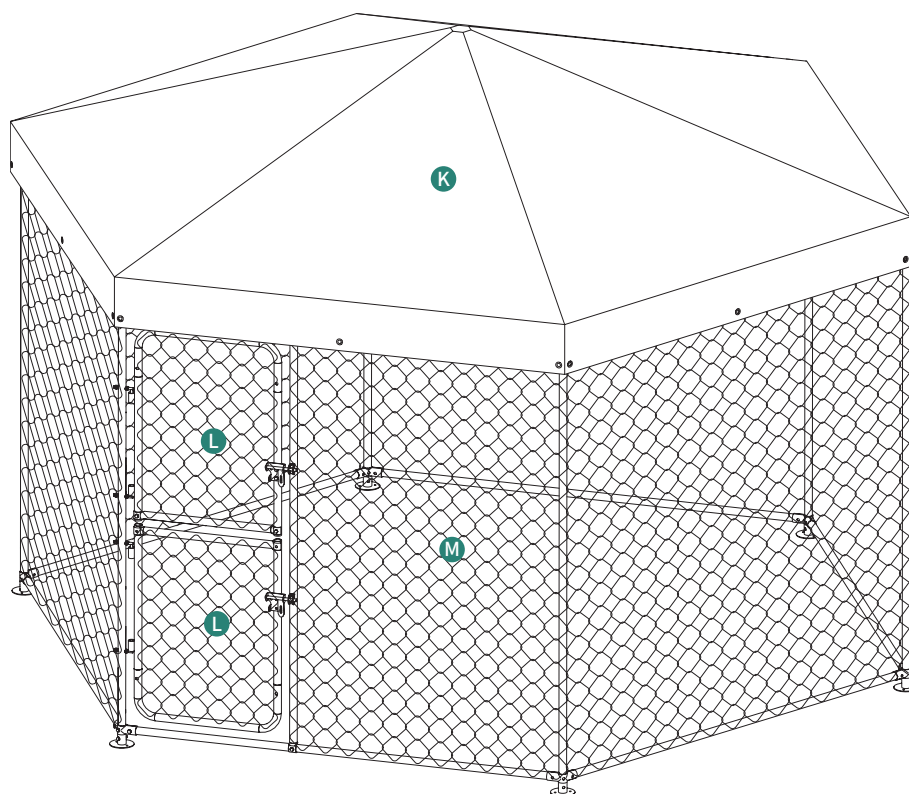
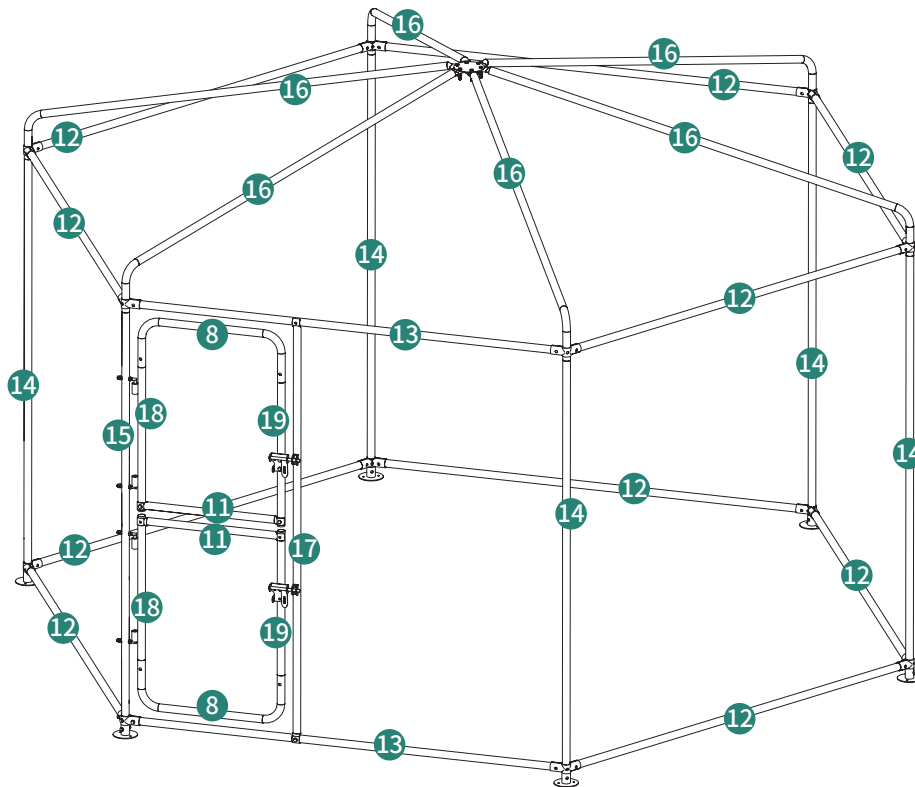

ASSEMBLY

1

L:1470mm

L:1470mm

L:1510mm

L:1510mm

M6X45mm

M6X40mm

-  ⑫ 5 pcs
-  ⑬ 1 pc
-  ⑭ 5 pcs
-  ⑮ 1 pc
-  ① 6 pcs
-  ④ 6 pcs
-  ⑤ 6 pcs
-  ⑦ 18 pcs
-  ⑧ 6 pcs

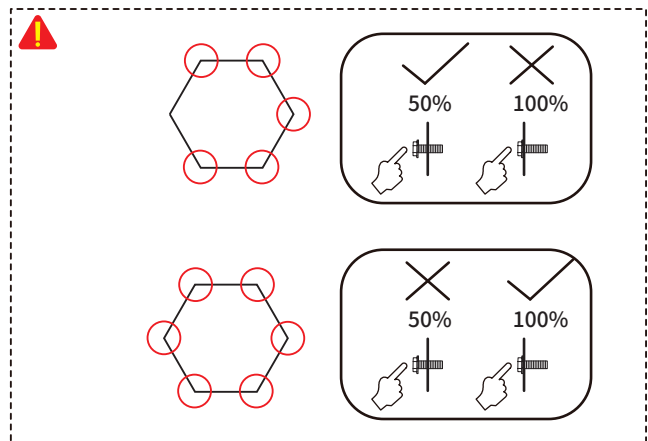
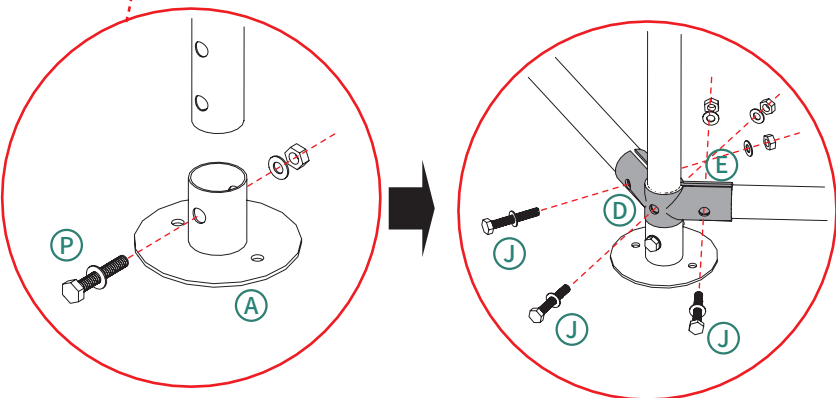
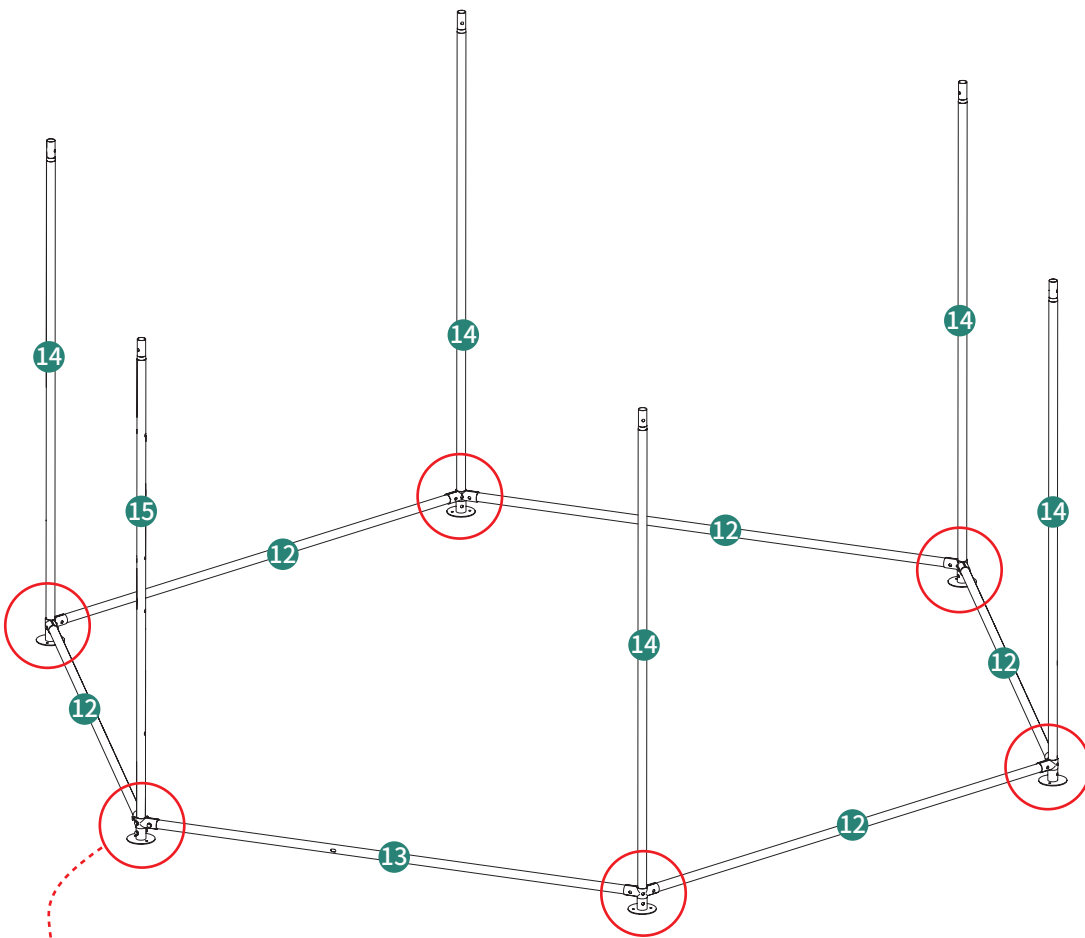
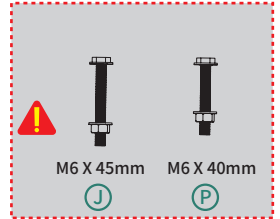

2

L:1470mm

L:1470mm

M6X45mm

M6X40mm

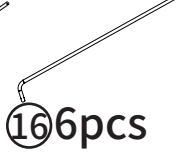
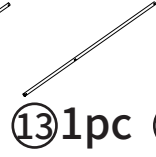
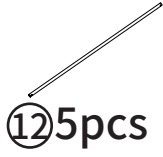

⑫5pcs ⑬1pc ⑯6pcs



①6pcs



②6pcs



③18pcs



④6pcs



⑤1pc

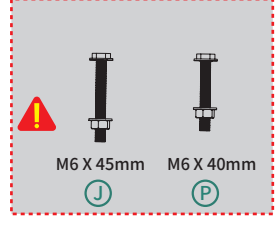
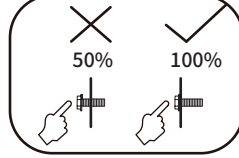
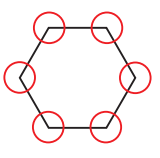
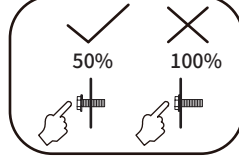
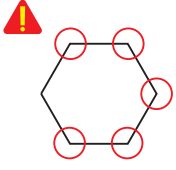

M6 X 45mm M6 X 40mm

③ ④

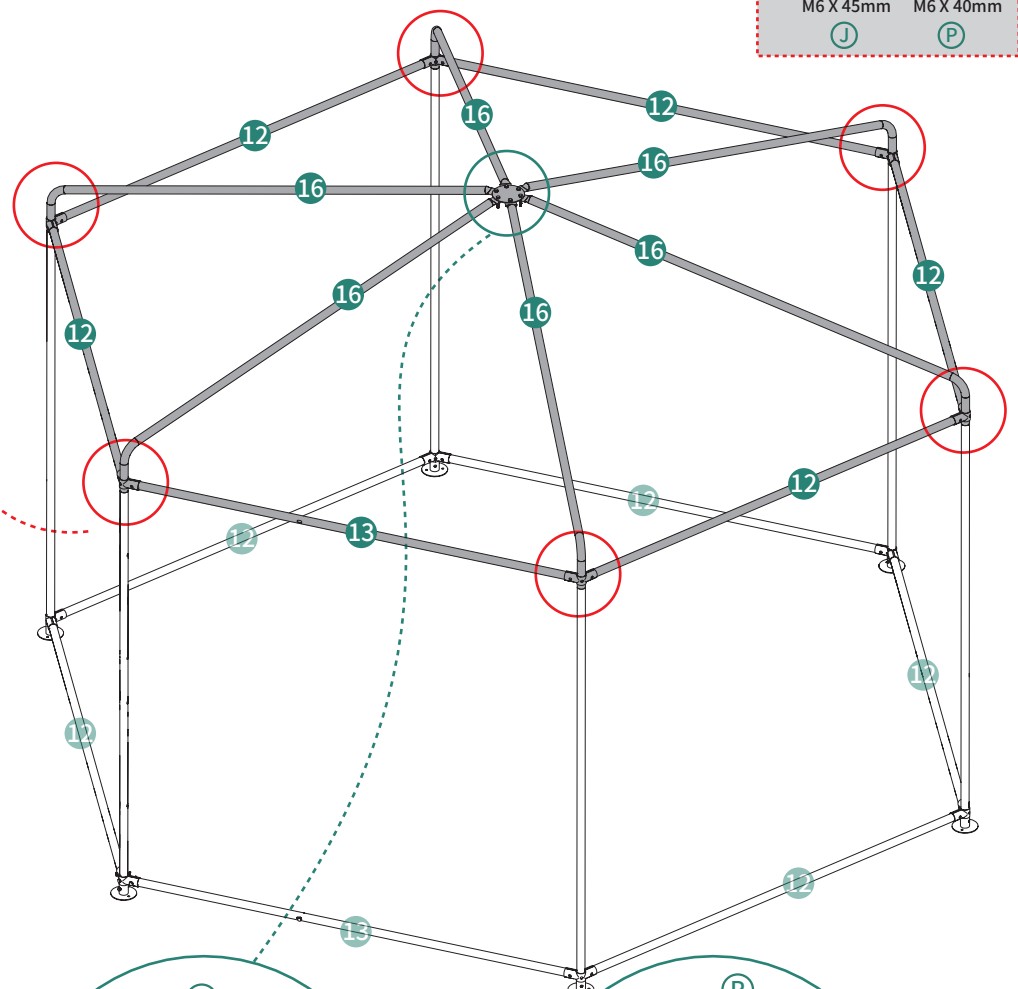
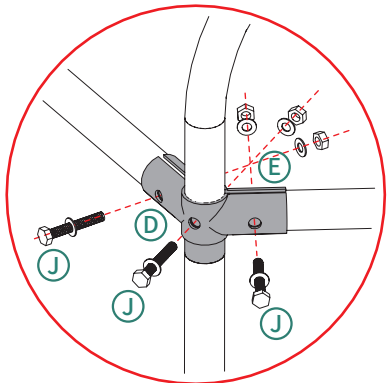
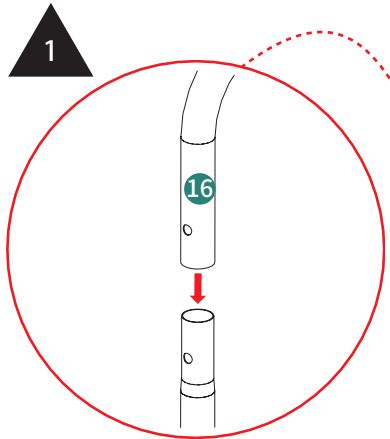

2

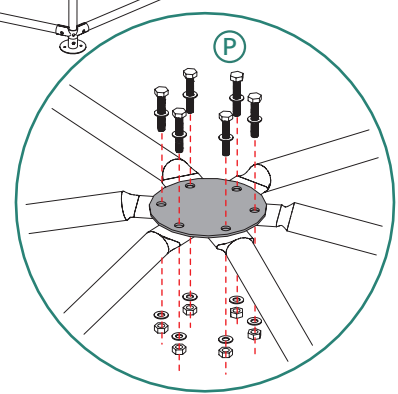
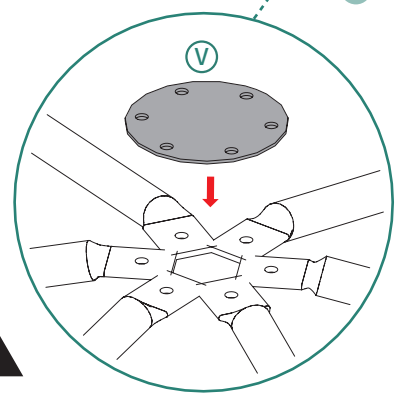

4

L:500mm



⑧ 2pcs

L:475mm

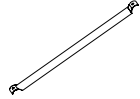

⑪ 2pcs

L:555mm

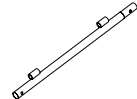

⑱ 2pcs

L:555mm

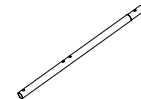

⑲ 2pcs

M6X40mm



Ⓟ 8pcs

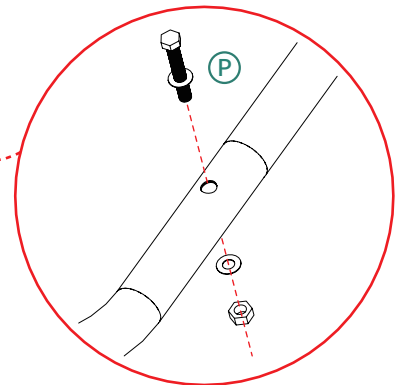
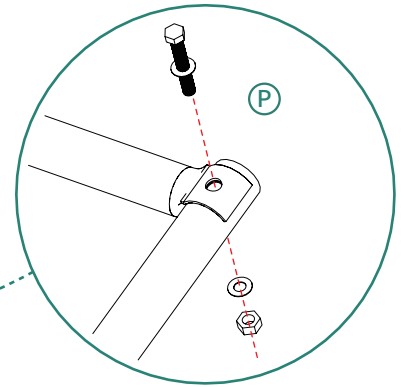
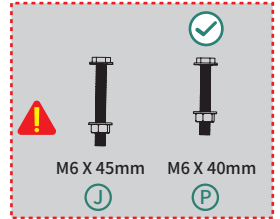
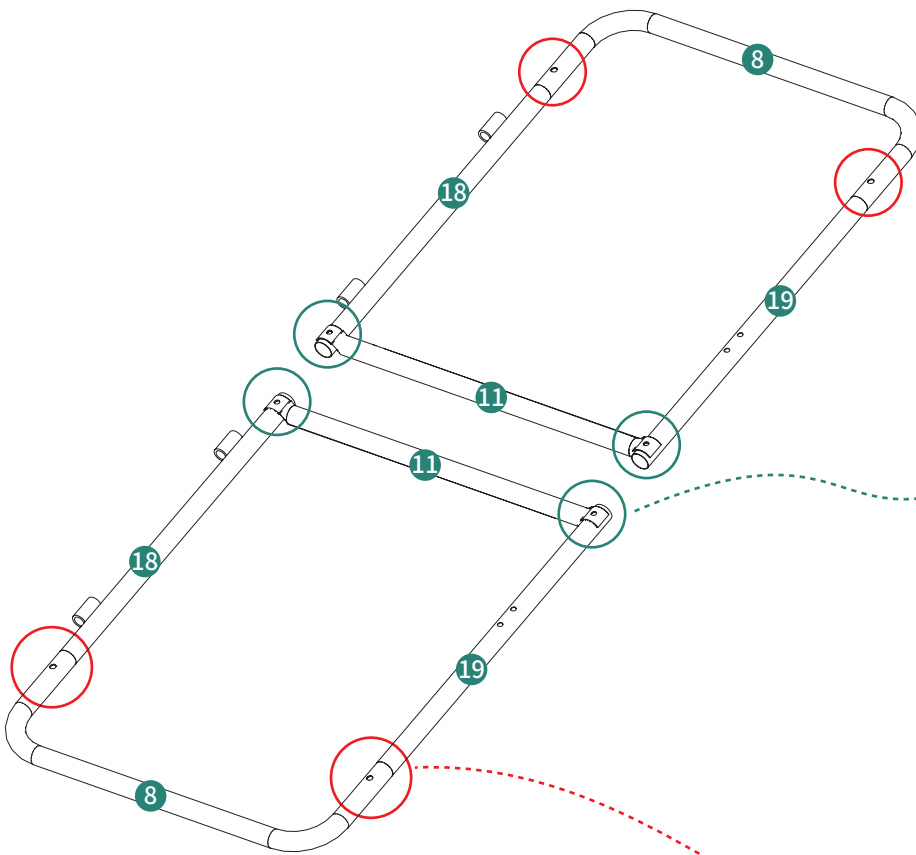

5

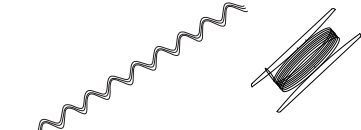

Ⓛ 2pcs Ⓝ 1pc

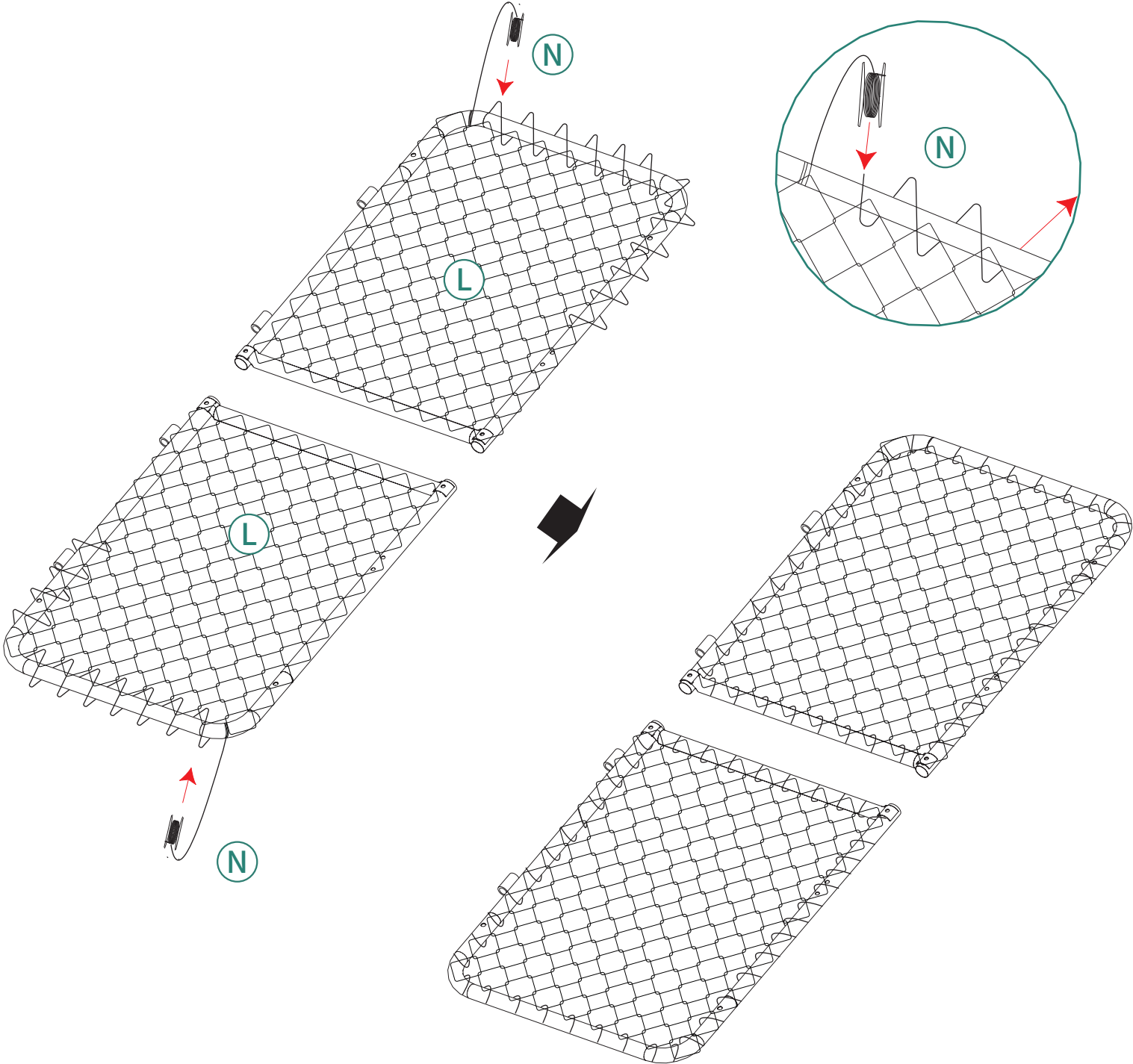

6

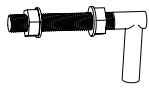

ⓕ 4pcs

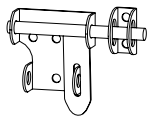

ⓖ 2pcs

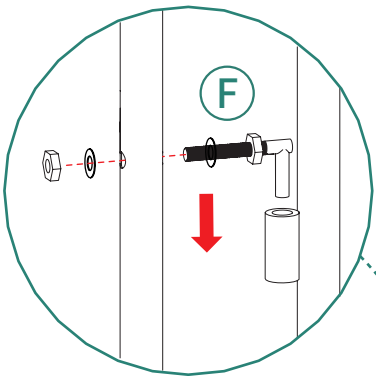
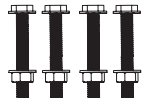

2

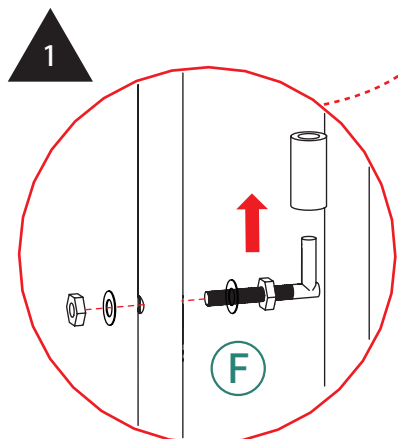
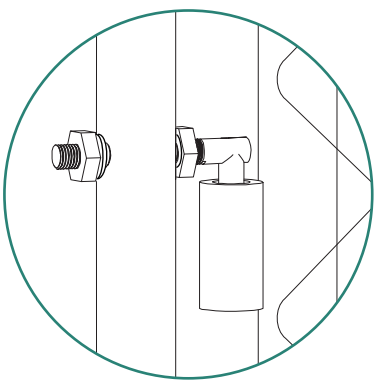

1

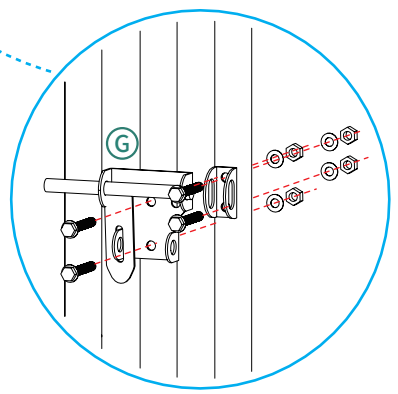
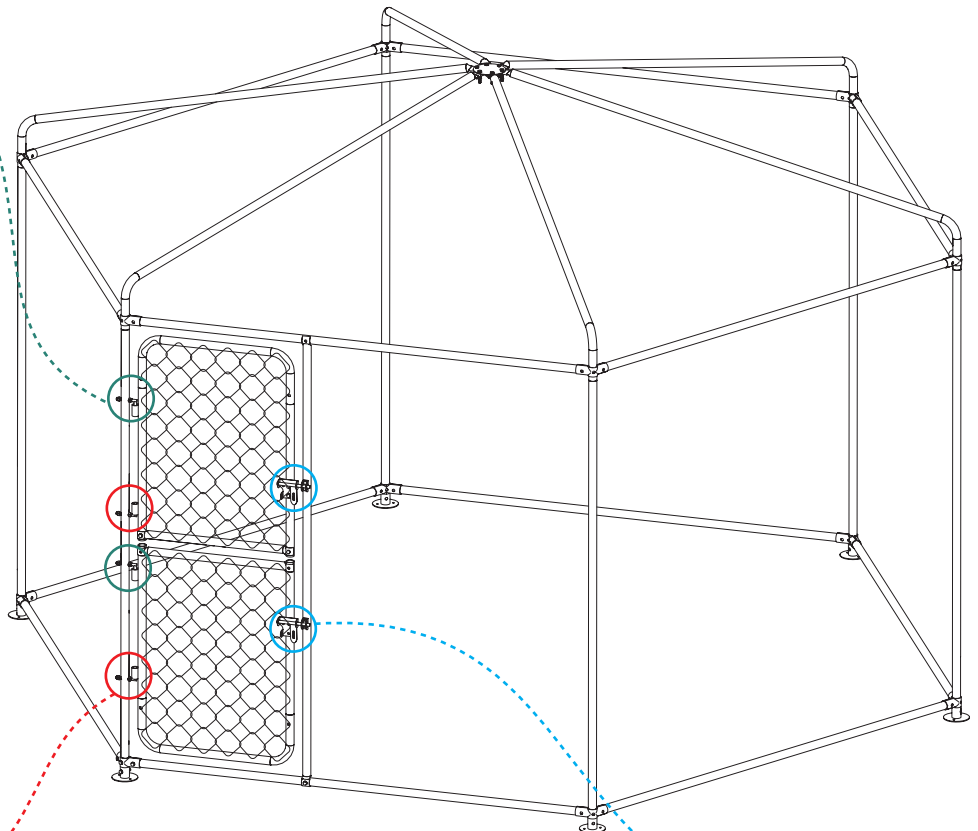
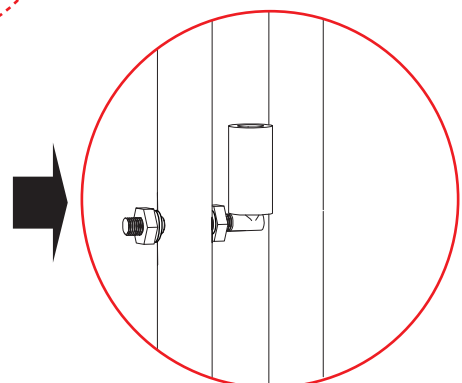

7



M 1pc

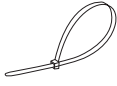

Q 14pcs

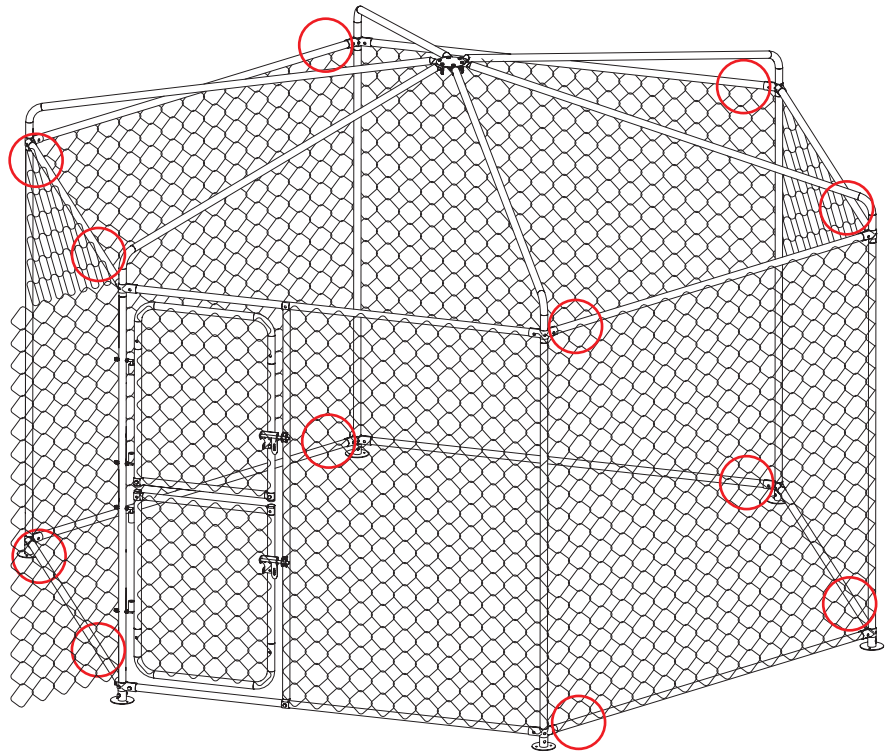
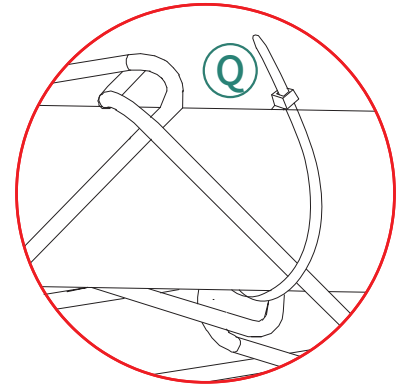
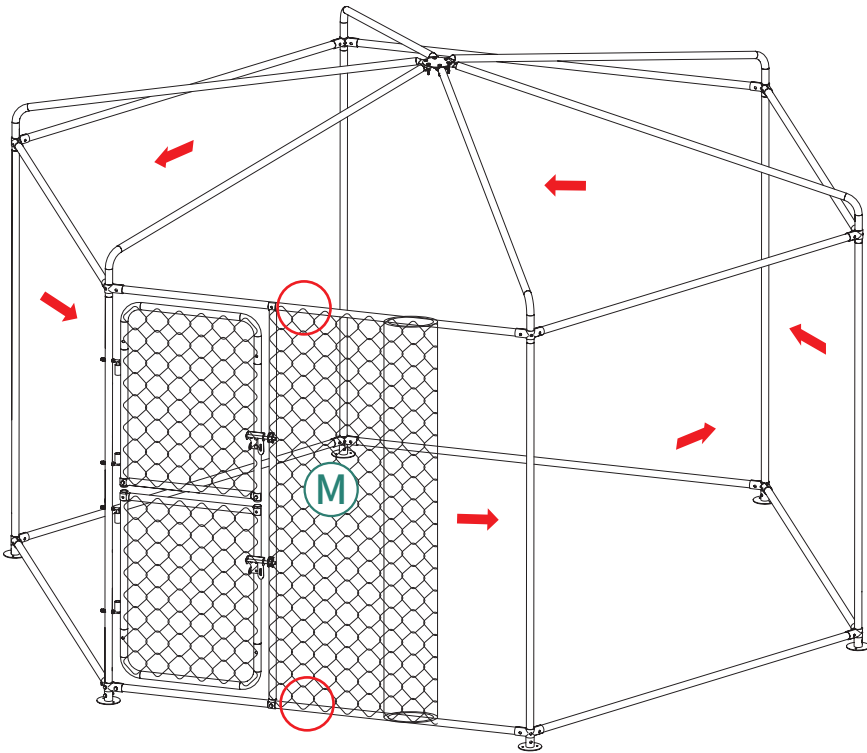

8

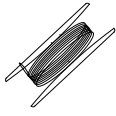

Ⓝ1pc

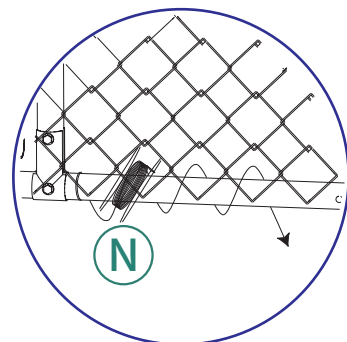
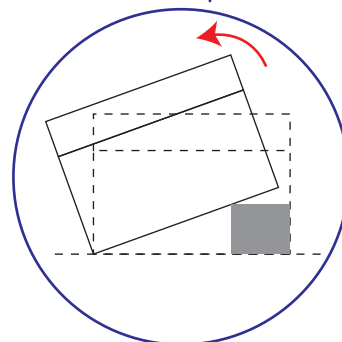
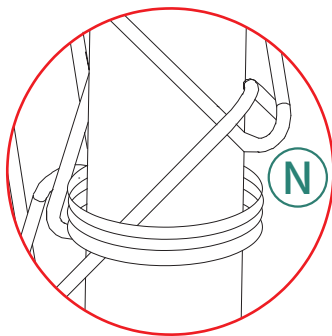
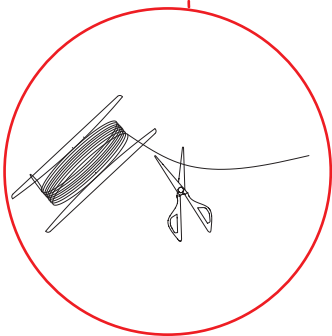
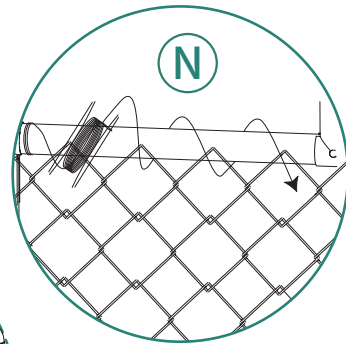
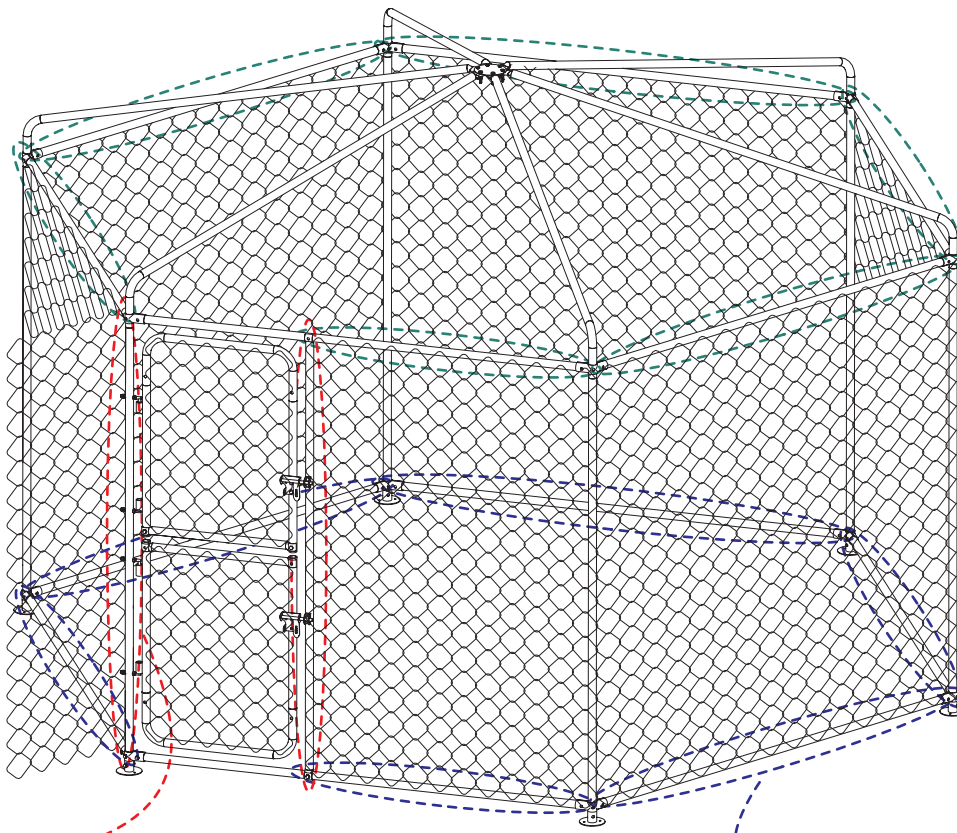

9

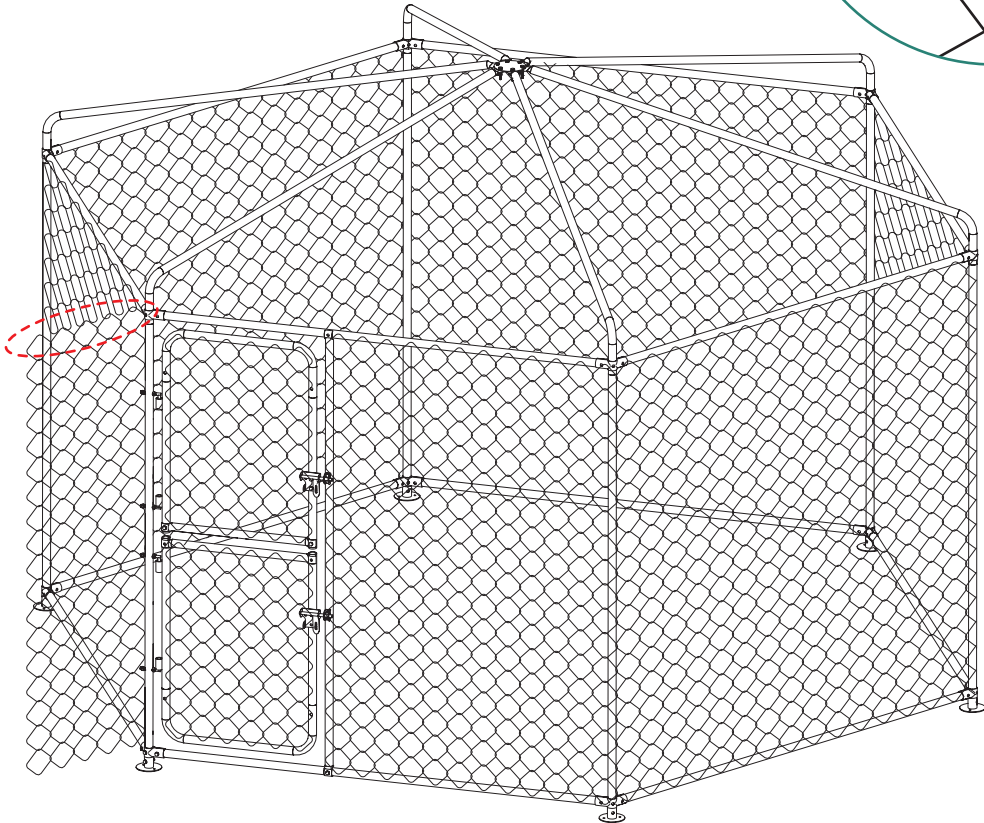
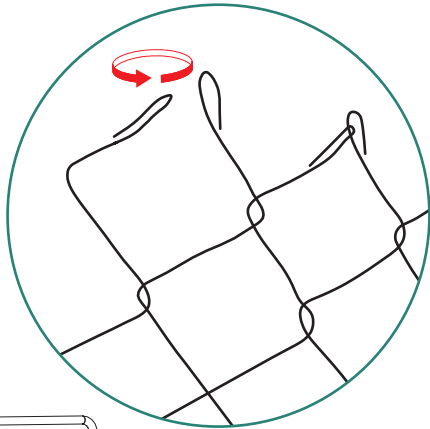
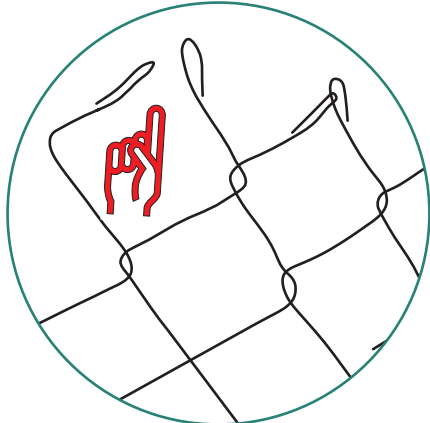

10



Ⓚ1pc

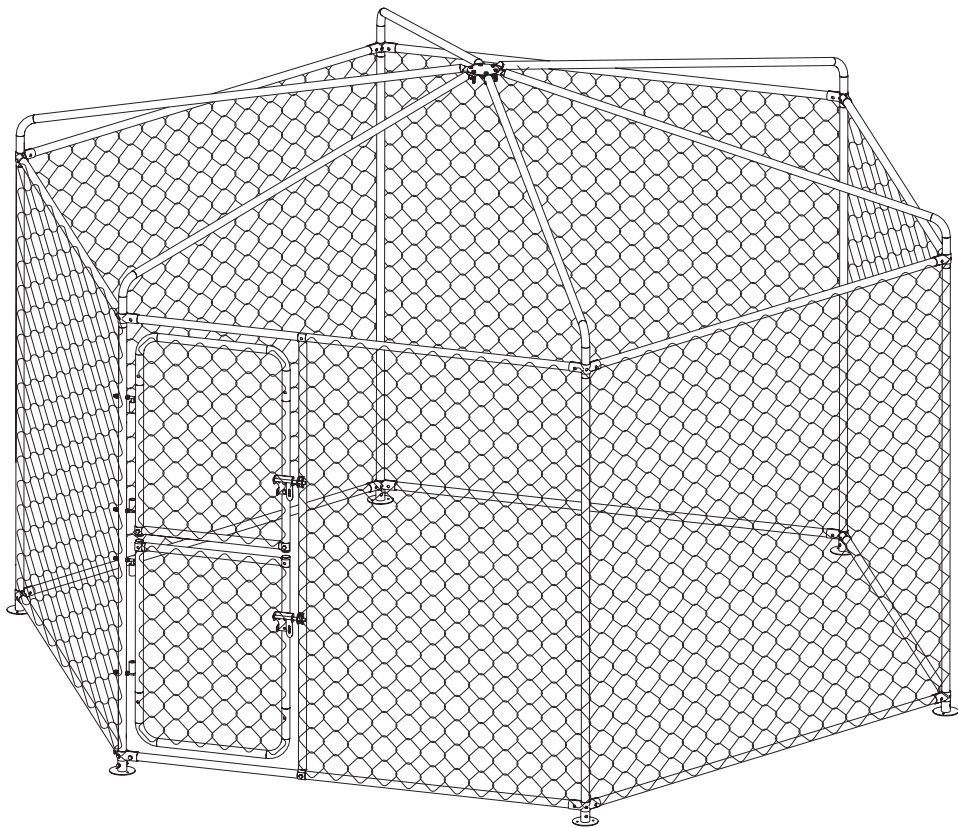
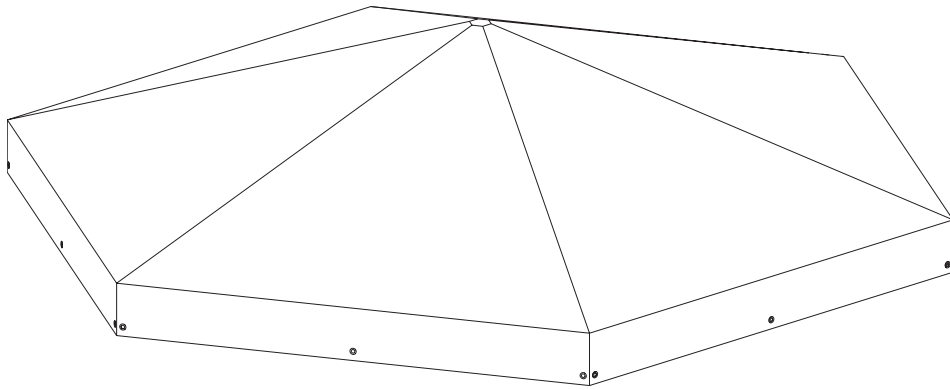

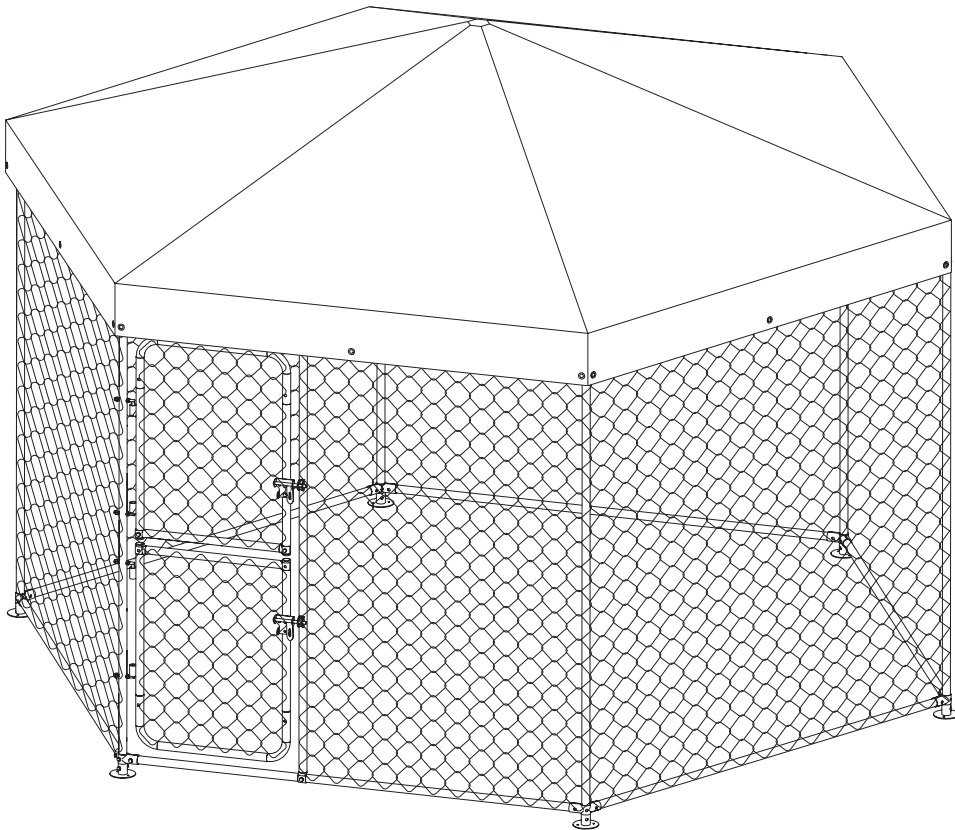
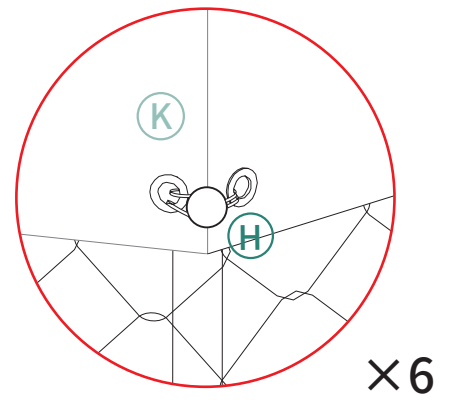
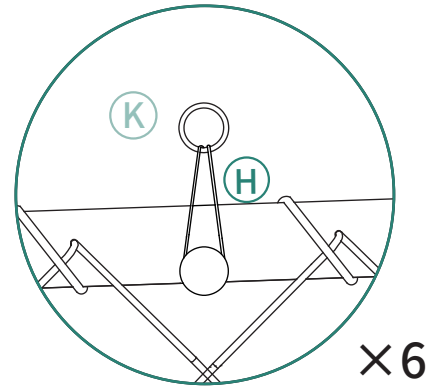
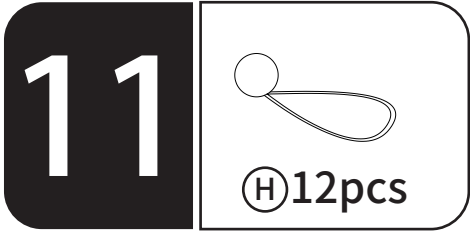

12



Ⓡ 6pcs

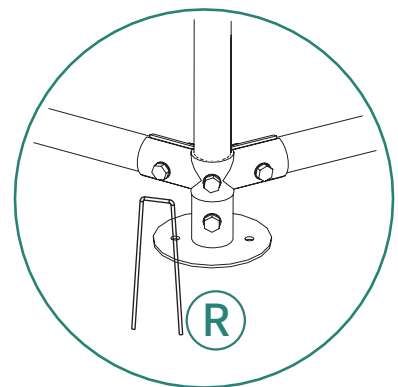
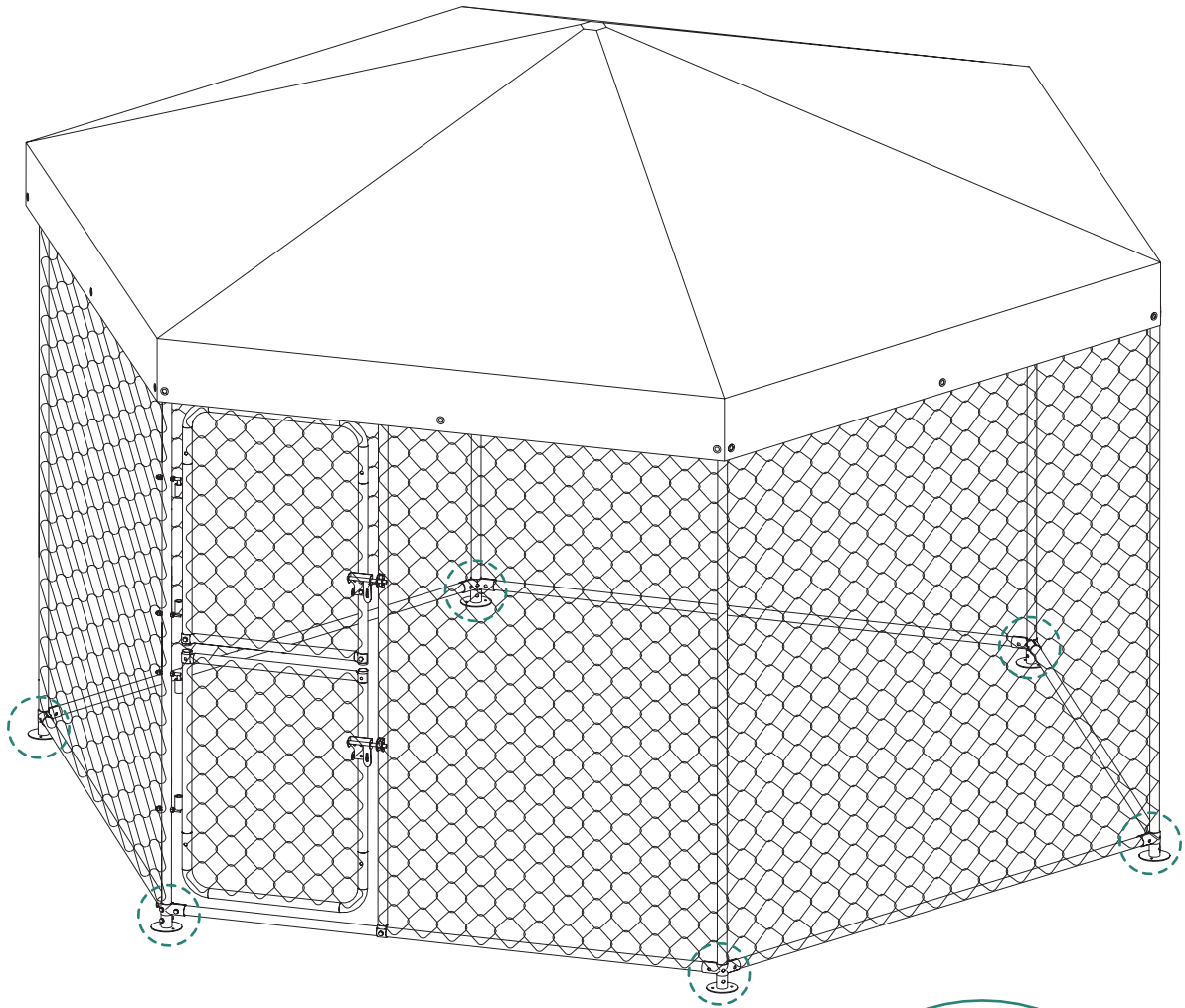

HELP CENTER



Inquiry



Assembly issue



Missing parts

If you encounter any difficulties during assembly, please contact us.

Wenn Sie während der Montage auf Schwierigkeiten stoßen, kontaktieren Sie uns bitte.

Si vous rencontrez des difficultés lors du montage, veuillez nous contacter.

Se incontri difficoltà durante il montaggio, ti preghiamo di contattarci.

Si encuentras alguna dificultad durante el ensamblaje, por favor contáctanos.

DISCLAIMER

Manufacturer and seller expressly disclaim any and all liability for personal injury, property damage or loss, whether direct, indirect, or incidental, resulting from the incorrect attachment, improper use, inadequate maintenance, unapproved modification, or neglect of this product.

Der Hersteller und Verkäufer lehnen ausdrücklich jegliche Haftung für Personenschäden, Sachschäden oder Verluste ab, egal ob direkt, indirekt oder zufällig, die durch falsche Anbringung, unsachgemäßen Gebrauch, unzureichende Wartung, nicht genehmigte Änderungen oder Vernachlässigung dieses Produkts entstehen.

El fabricante y vendedor renuncian expresamente a toda responsabilidad por lesiones personales, daños materiales o pérdidas, ya sean directos, indirectos o incidentales, derivados de la incorrecta colocación, uso inadecuado, mantenimiento insuficiente, modificación no aprobada o negligencia de este producto.

Il produttore e il venditore declinano espressamente ogni responsabilità per lesioni personali, danni materiali o perdite, dirette, indirette o incidentali, derivanti dall'errato fissaggio, uso improprio, manutenzione inadeguata, modifica non autorizzata o negligenza di questo prodotto.

Le fabricant et le vendeur déclinent expressément toute responsabilité en cas de blessures corporelles, de dommages matériels ou de pertes, qu'ils soient directs, indirects ou accessoires, résultant de la fixation incorrecte, de l'utilisation inappropriée, de l'entretien insuffisant, de la modification non approuvée ou de la négligence de ce produit.