

# Installation Instruction

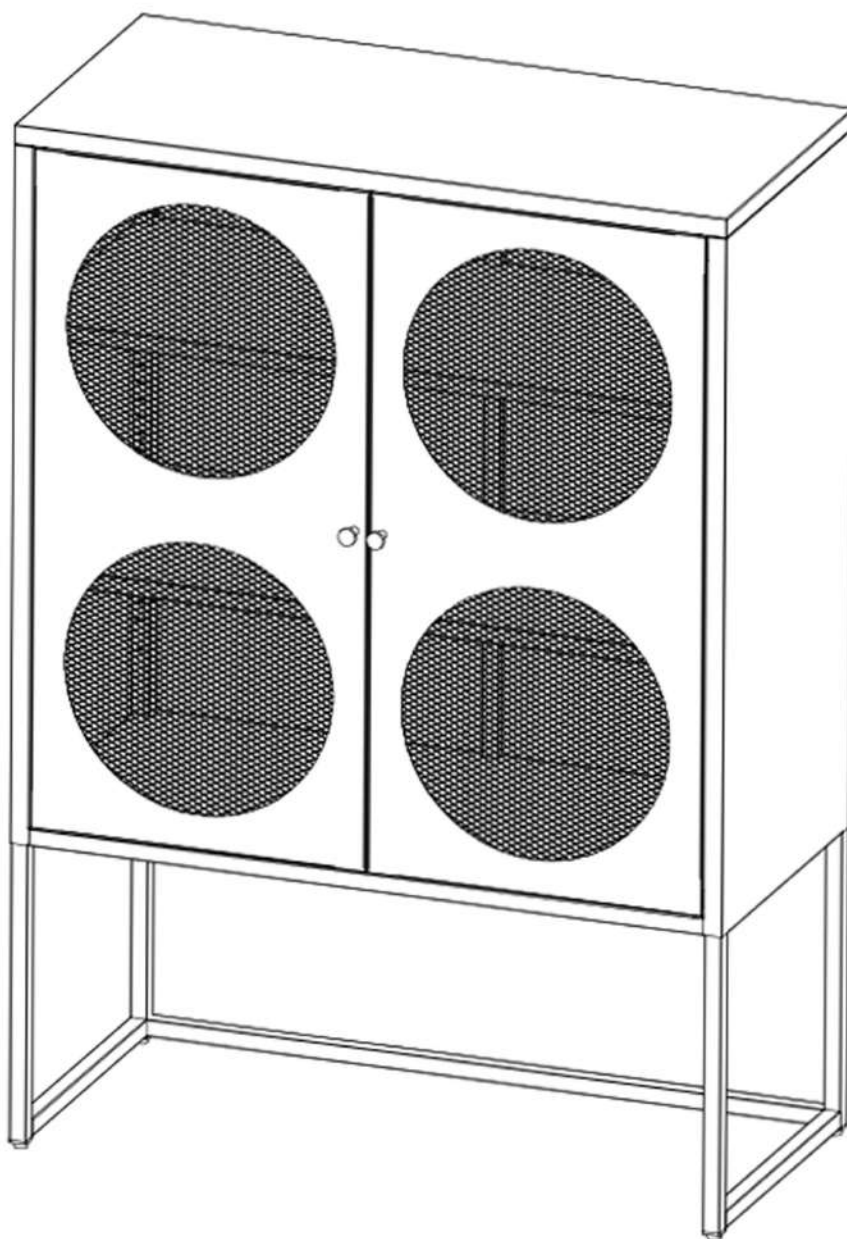







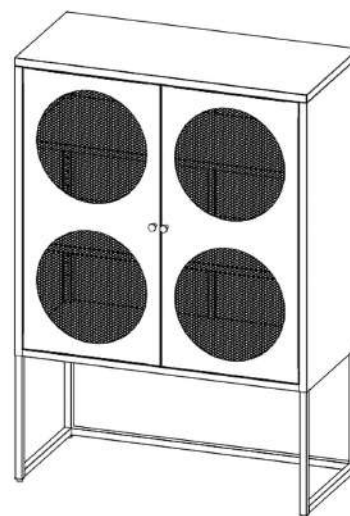

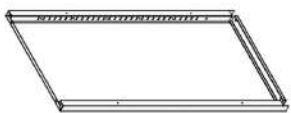

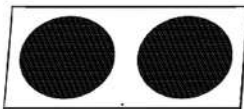

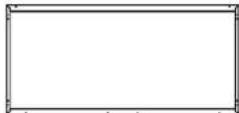

Hi friend, thank you for purchasing me, we finally meet!  
After you received me, please take a few minutes to read the instruction manual so that you can use me better. If you have any questions, please contact my seller, they are always there.

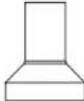
# Installation Instruction

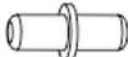
- Please read the complete assembly instructions carefully before assembling the cabinet.
- Check the materials to make sure they are working correctly and are not damaged.
- Cabinets should be assembled on a flat surface.
- Refer to the illustrations to identify the parts and accessories of the cabinet.



 Side Plate	 Clapboard & Bottom Plate	 Door Plate	 Left Back Plate
2 PCS	3 PCS (Same)	2 PCS	1 PC
 Right Back Plate	 Top Plate	 Cross Bar	 Back Floor Frame
1 PC	1 PC	2 PCS	1 PC
 Front Floor Frame	 Door Handle	 Buckle	 Door Spindle
1 PC	2 PCS	8 PCS	2 PCS
 Door Spindle Pad	 M5*10 Screw	 M4*22 Screw	 Adjustable Foot
4 PCS	20 PCS	4 PCS	4 PCS

# Installation Instruction

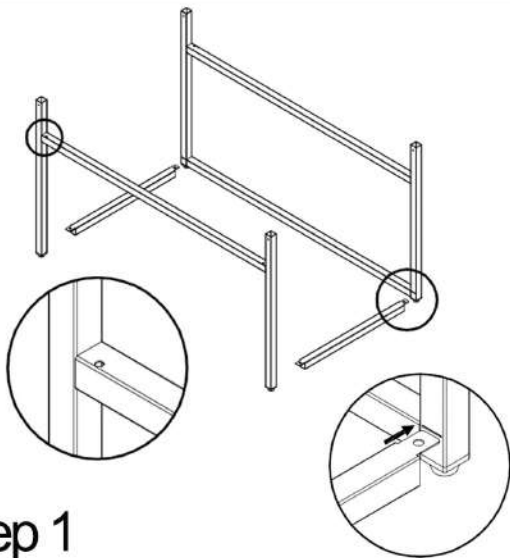

## Step 1

Insert the cross bar into floor frames.

Note: Opening of door-hinge should be outward. Before installation, install the adjusting foot under the floor frames first.

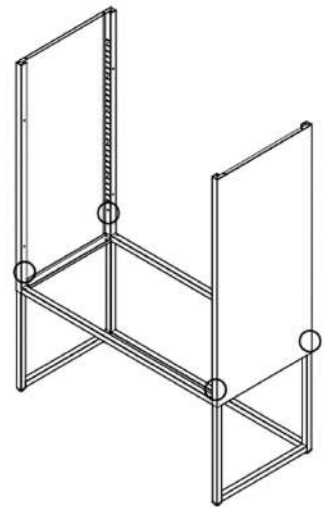

## Step 2

Install the side plate.  
Using M5\*10 screw to fix it.

 x 4

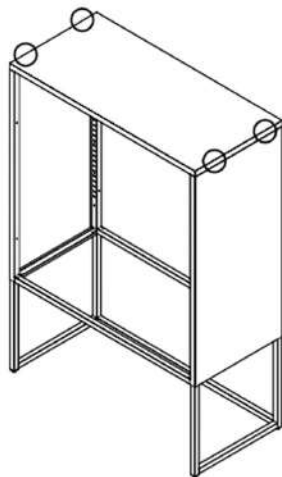
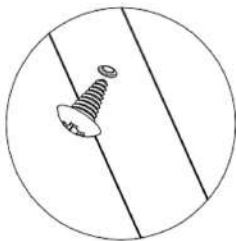

## Step 3

Install the top plate.  
Using M5\*10 Screw to fix it.

 x 4

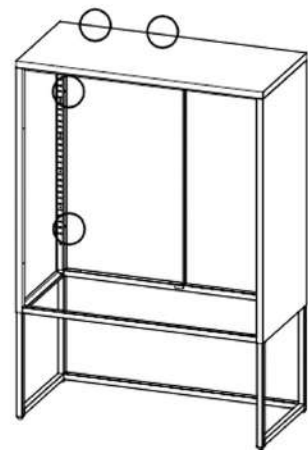

## Step 4

Install the left back plate.  
Using M5\*10 Screw to fix it.

 x 4

# Installation Instruction

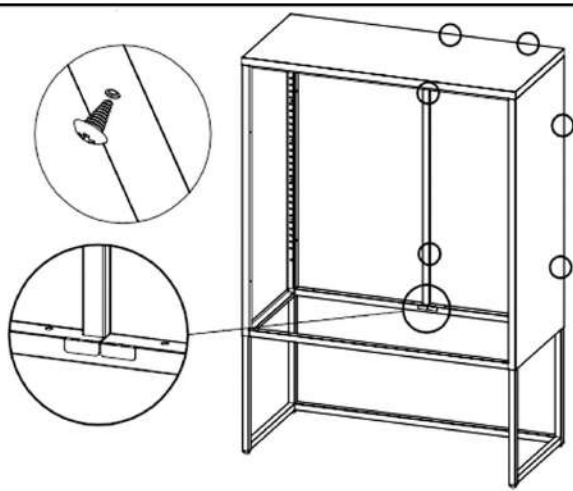

## Step 5

Install the right back plate.  
Using M5\*10 Screw to fix it.

Note: Bend the convex parts  
and fix on the frame.

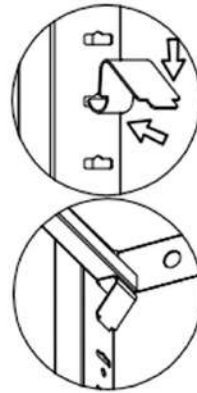

## Step 6

Install the clapboard buckle  
and place the clapboards.

Note: The clapboards look  
same as bottom panel.

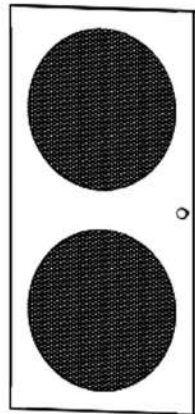

## Step 7

Install the door handle,  
Using M4\*22 Screw to fix it.

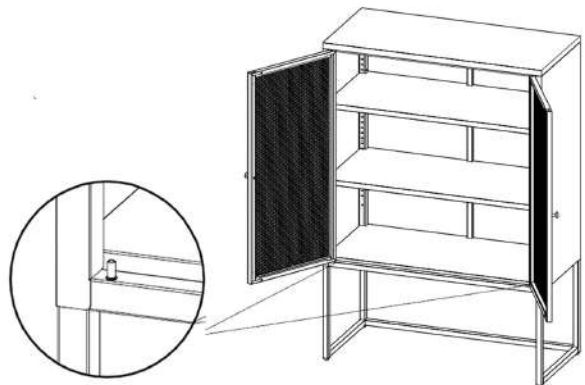

## Step 8

Install the door spindle, and place  
the door spindle pad appropriately.  
Align top and bottom of the door  
with the door spindle hole, install  
bottom first, then top.

