

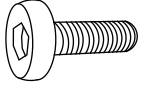
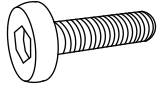
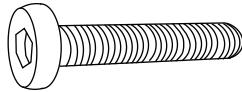

ASSEMBLY INSTRUCTIONS

NO.: DK-10307

<p>A</p>  <p>M6*20mm X4</p>	<p>B</p>  <p>M6*25mm X4</p>	<p>C</p>  <p>M8*60mm X1</p>	<p>D</p>  <p>M8*22mm X5</p>	<p>E</p>  <p>M6*16mm X4</p>
<p>F</p>  <p>M6 X4</p>	<p>G</p>  <p>M4 X1</p> <p>H</p>  <p>M6 X1</p>	<p>I</p>  <p>X1</p>	<p>J</p>  <p>X1</p>	<p>K</p>  <p>X1</p>

STEP 1

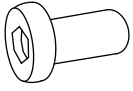
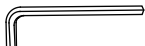
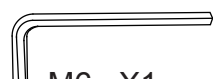
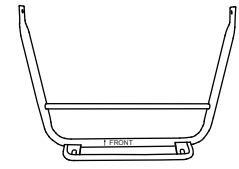
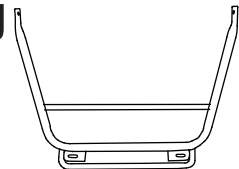
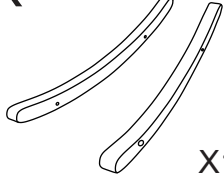
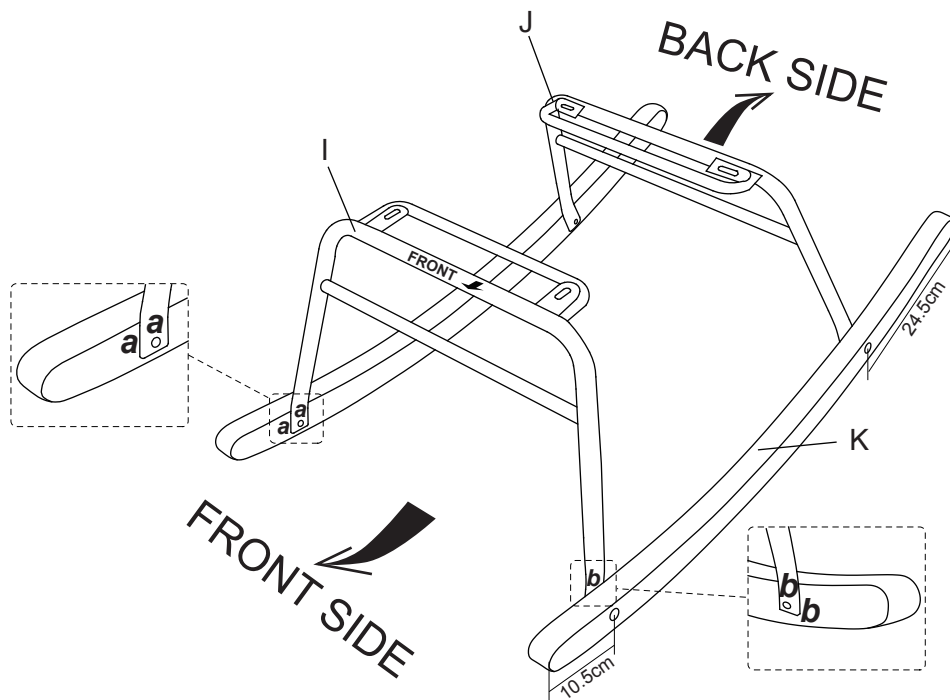

STEP 2

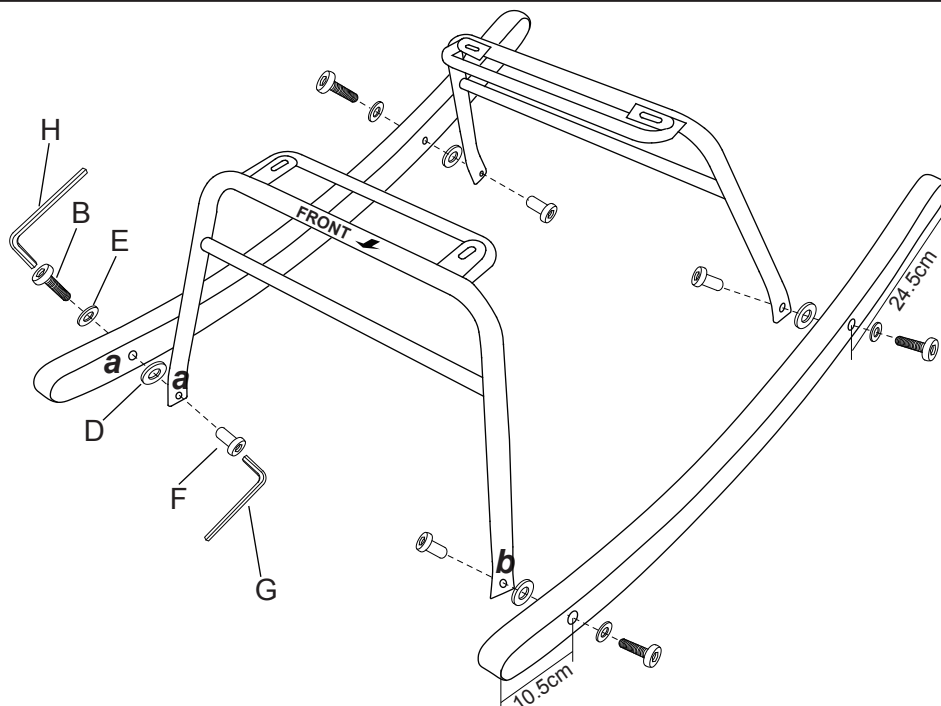

STEP 3

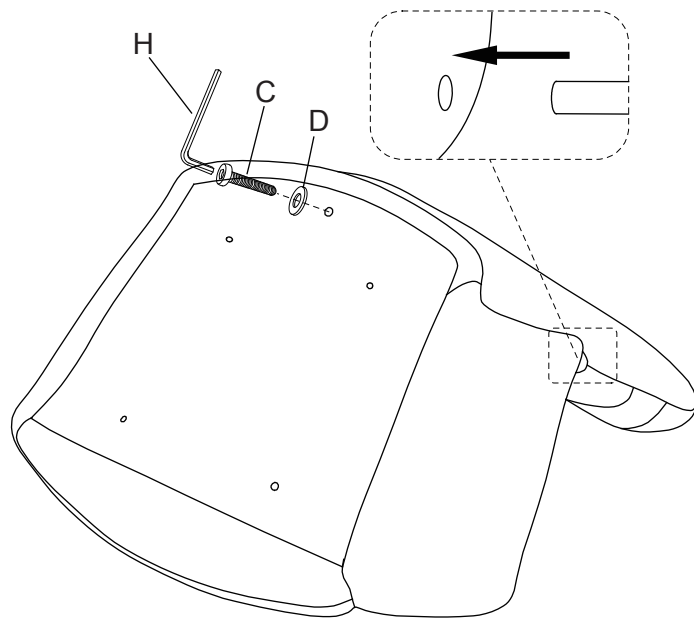

STEP 4

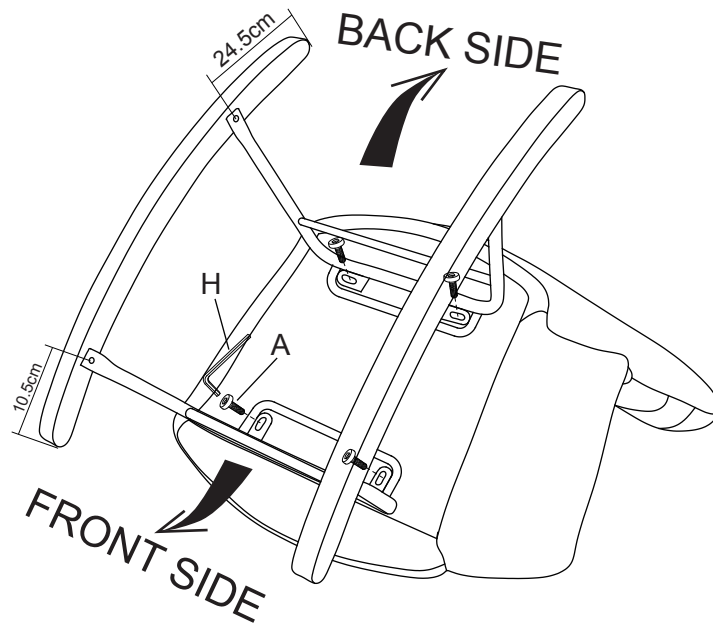

STEP 5

