

# USER GUIDE

## SURFACE-MOUNT MEDICINE CABINET DOUBLE DOOR WITH LED LIGHTING



# IMPORTANT SAFETY INFORMATION

Please read through this installation instruction so you will know how to install and operate your model properly. Keep this document in a safe place for future reference after use.

## **WARNING**

This product must be installed in accordance with the installation instruction by qualified technician. Failure to follow instruction could result in death or serious bodily injury.

## **CAUTION**

This product must be serviced by qualified personnel. ALWAYS unplug the power cord or turn off the circuit breaker before service.

# PACKAGE CONTENTS

## Cabinet

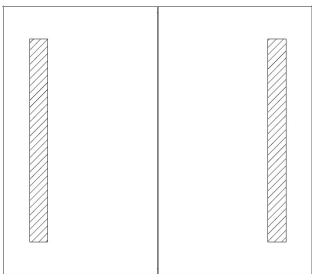

(x1)

## Glass Shelf



(x2)

## Shelf Support Pin



(x8)

## Wood Screw



(x4)

# INSTALLATION

1

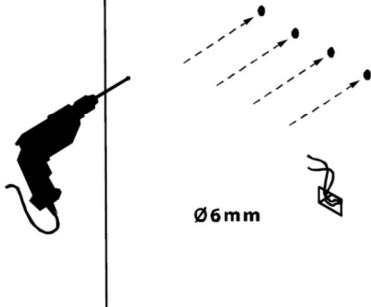

Ø6 mm

For drywall installation, mark the hole locations and drill  $\Phi$  6mm holes for the drywall anchors. Install a junction box behind the mirror for power connections.

2

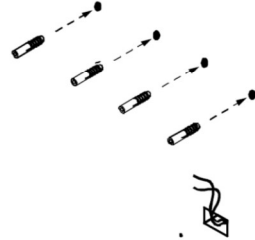

Insert provided drywall anchors.

3

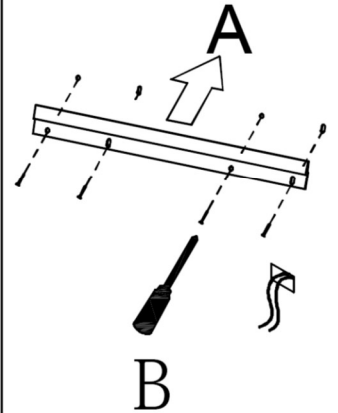

Install the mounting bracket.

4

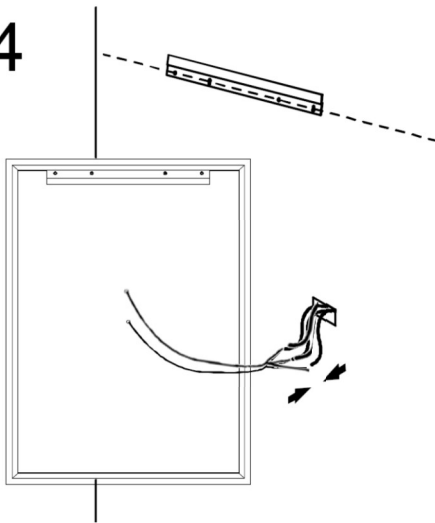

Connect the load (black) wire of the Dimming driver cable (white) to wall switch if used. Connect the load (black) wire of the Touch Switch cable (black) to hot wire.

5

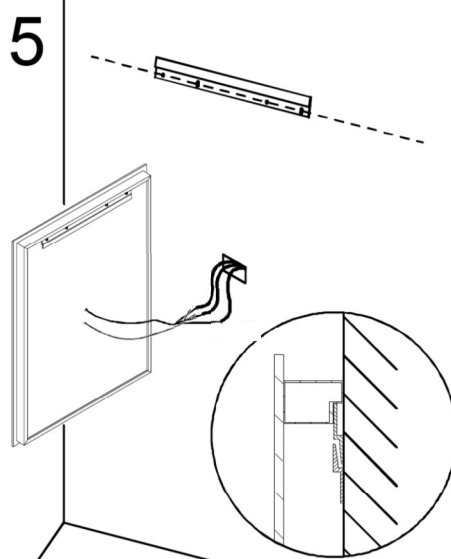

Hang the mirror to the wall and make sure the bracket in the back of the mirror lineup with the mounting bracket properly.

6

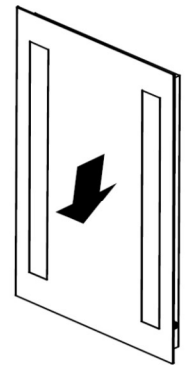

Press the mirror down slightly and make sure the brackets fit properly.



- Using the wall studs to hang the mirror is highly recommended.

# INSTALLATION DIMENSIONS

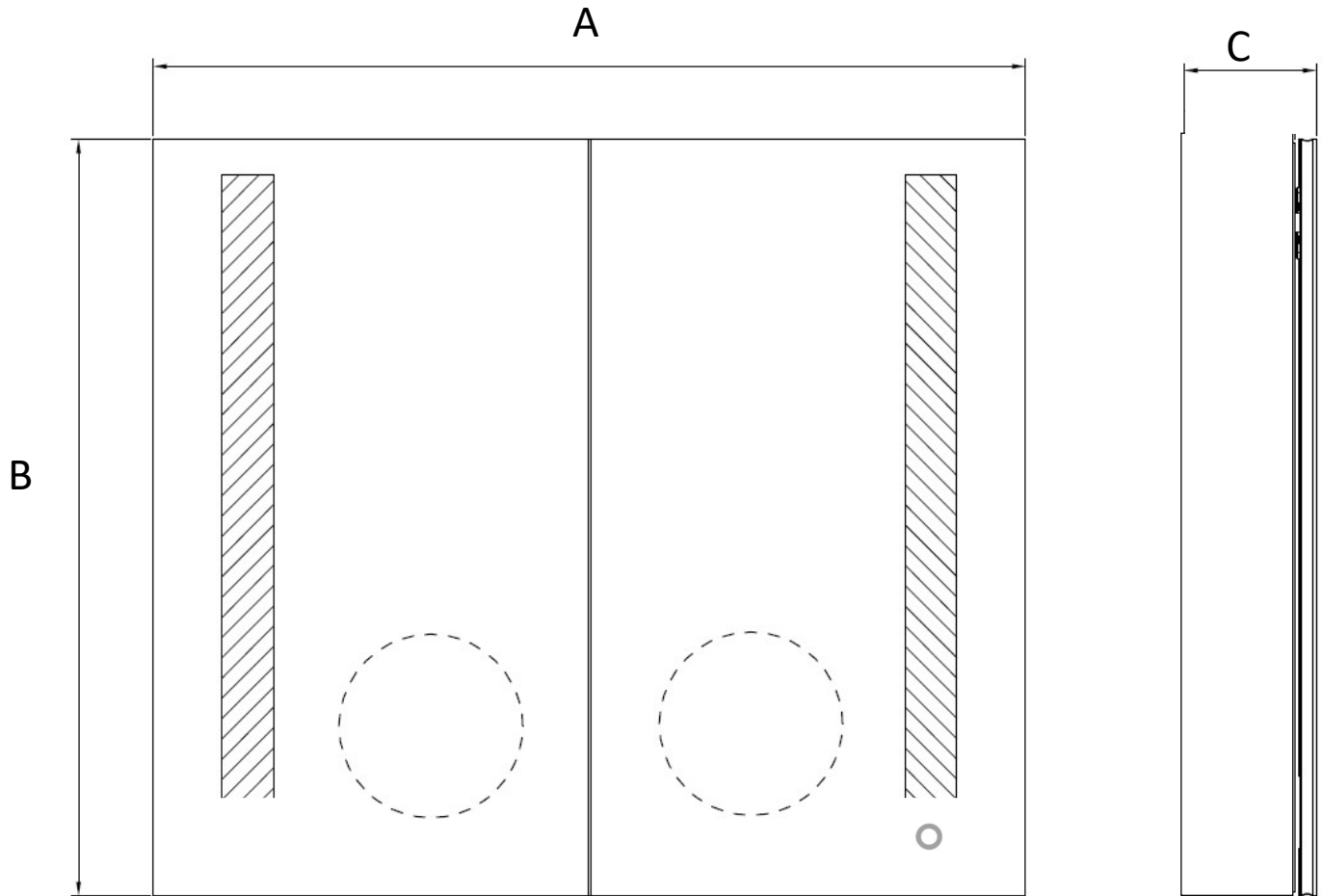

A	B	C
40	26	5-1/4

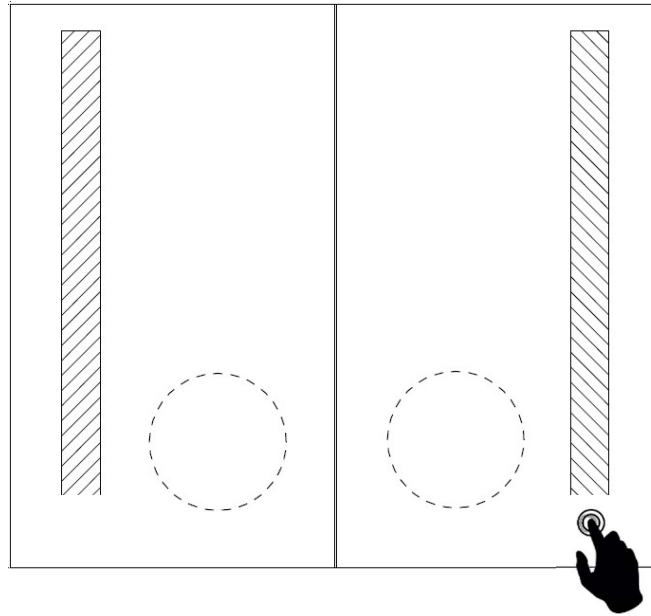

## 1. Touch switch

- a. Press the switch once to turn on/off the LED lights.
- b. When the lights are on, press and hold the switch for about 3 seconds to change the color temperature.

## CARE AND MAINTENANCE

Clean the mirror with a soft, damp cloth and dry thoroughly with a soft towel. Do NOT allow the edges of the mirror to get or remain wet over a period of time. Please do NOT use glass cleaner that contains ammonia or vinegar. Never spray any cleaner directly onto a mirror. Instead apply the cleaner to a soft cloth and then wipe the mirror. Make sure no commercial cleaner comes in contact with the edge or backing.

## WARRANTY

### **5 years Limited Warranty**

LED mirrors have been manufactured under the highest standards of quality and workmanship. We warrant to the original purchaser that our LED mirrors are free from any defects in material and workmanship by normal use for 5 years from date of purchase. A replacement for any defective part will be supplied FREE OF CHARGE for installation by you. This warranty is valid to the original purchaser only and does not cover product damage due to installation error, product abuse, product misuse, etc. whether or not performed by professionals. We will not be responsible for labor charges and/or damage incurred in installation, repair or replacement nor for any incidental or consequential damages. All warranty claims should be sent to us or call our customer service representative will contact you promptly to help you go through the process until you are completely satisfied with our products.

**SHORTAGE OR DAMAGED PRODUCTS** All shipments are carefully inspected and counted before leaving our distribution centers. Please inspect carefully on receipt of merchandise, noting any discrepancy or damage on the carrier's freight bill at that time, and file a claim with the carrier within 10 days from receipt of order. Then contact our office. Deductions from invoices for shortages or damage claims will not be allowed.

# Exploded view

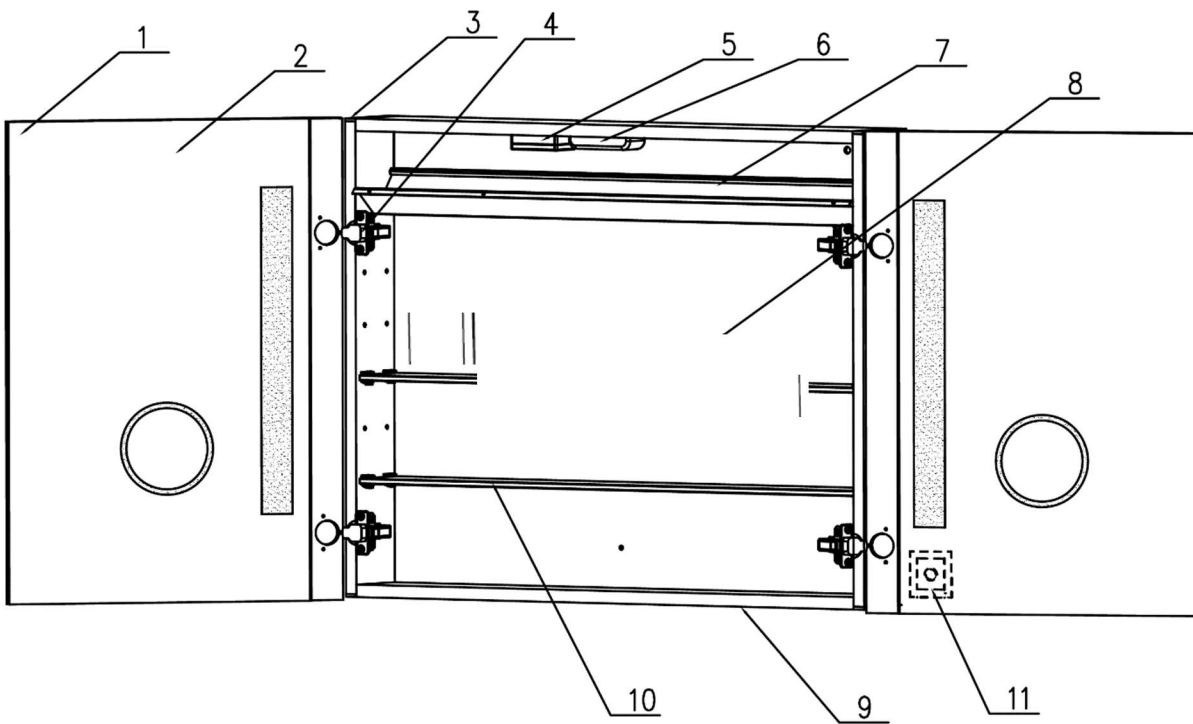

Part	Description
1	Mirror Door
2	LED Light
3	Cover
4	Hinge
5	AC & USB Outlets
6	LED Driver
7	Electrical Cover
8	Back Mirror
9	Aluminum Frame
10	Glass Shelf
11	Touch Switch