

ASSEMBLY INSTRUCTIONS

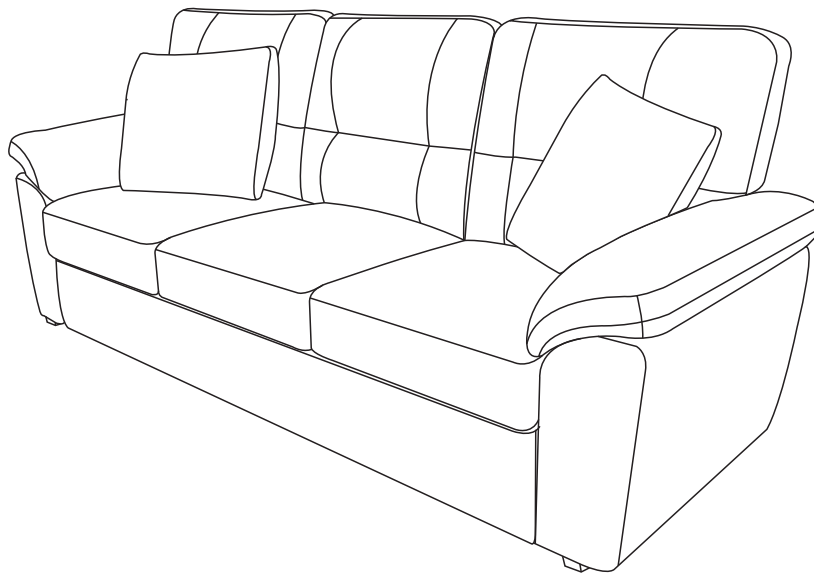

ASSEMBLY INSTRUCTIONS

ASSEMBLY TIPS:

1. Remove hardware from box and sort by size.
2. Please check to see that all hardware and parts are present prior to start of assembly.
3. Please follow attached instructions in the same sequence as numbered to assure fast & easy assembly.





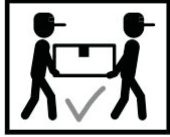

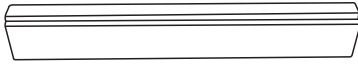

WARNING!

1. Don't attempt to repair or modify parts that are broken or defective. Please contact the store immediately.
2. This product is for home use only and not intended for commercial establishments.

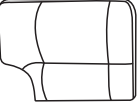
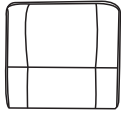
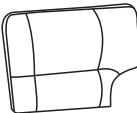

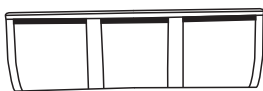
ASSEMBLY TIME | 12 MINUTES

Sofa is packed in 2 cases

CARTON	PARTS IDENTIFICATION	QUANTITY
SOFA	A  SEAT BACK BOTTON RAIL	1PC
	B  SEAT FRONT BOTTON RAIL	1PC
	C  LAFT BACK CUSHION	1PC
	D  MIDDLE BACK CUSHION	1PC
	E  RIGHT BACK CUSHION	1PC
	F  SEAT BASE	1PC
	G  BACK FRAM	1PC
	H  LEGS	4PCS
	ARM	I  LEFT ARM
J  RIGHT ARM		1PC
K  PILLOWS		2PCS

ASSEMBLY INSTRUCTIONS

STEP 1

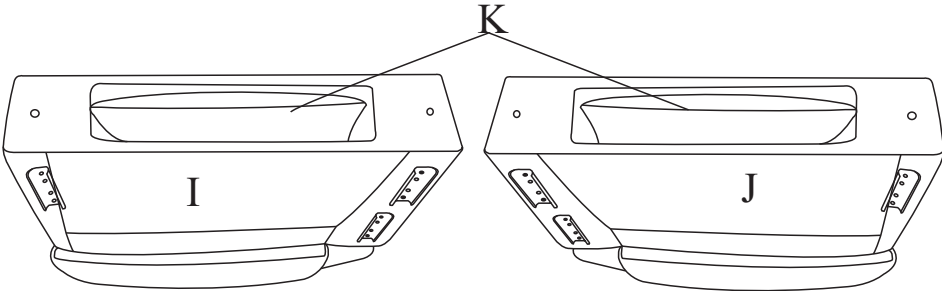

PILLOWS TAKE OUT FROM ARM INSIDE

STEP 2

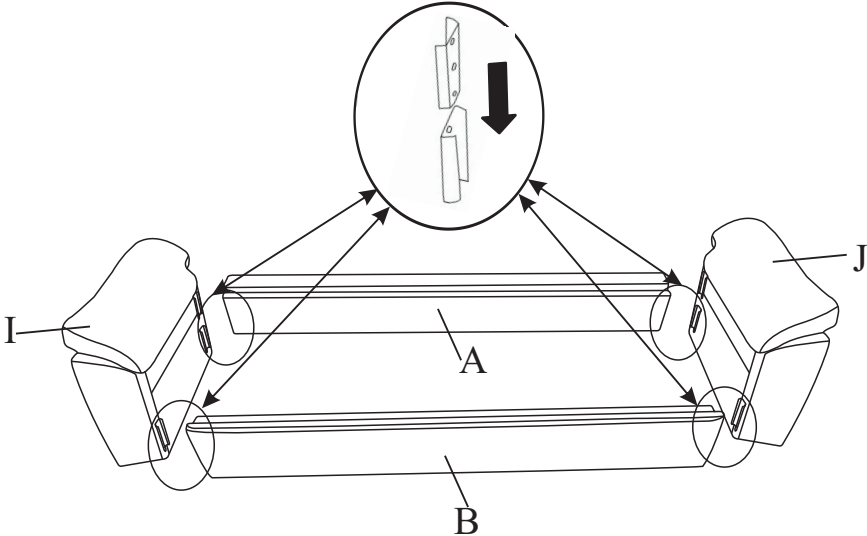

ASSEMBLY INSTRUCTIONS

STEP 3

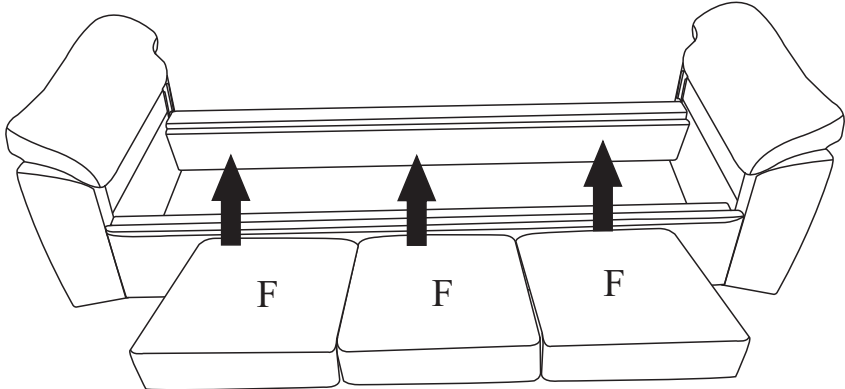

STEP 4

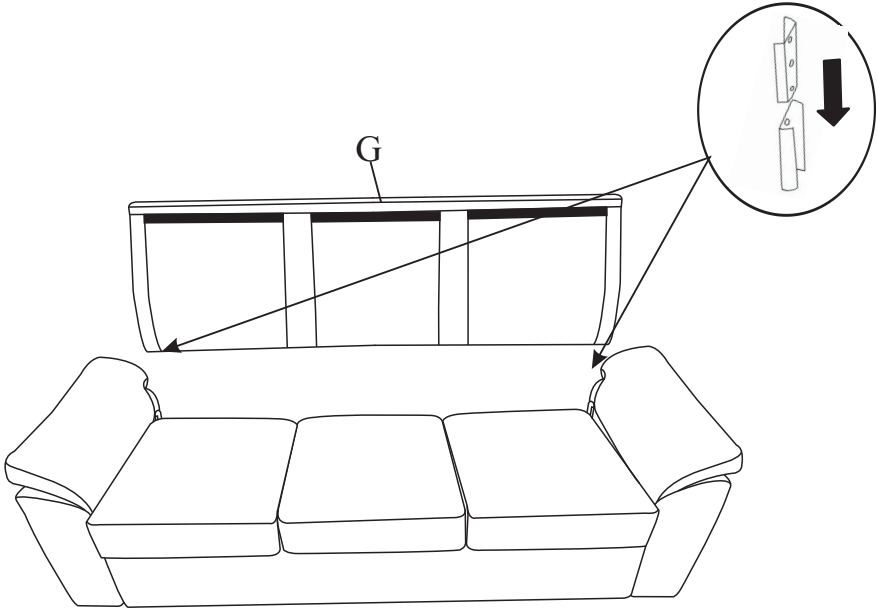

STEP 5

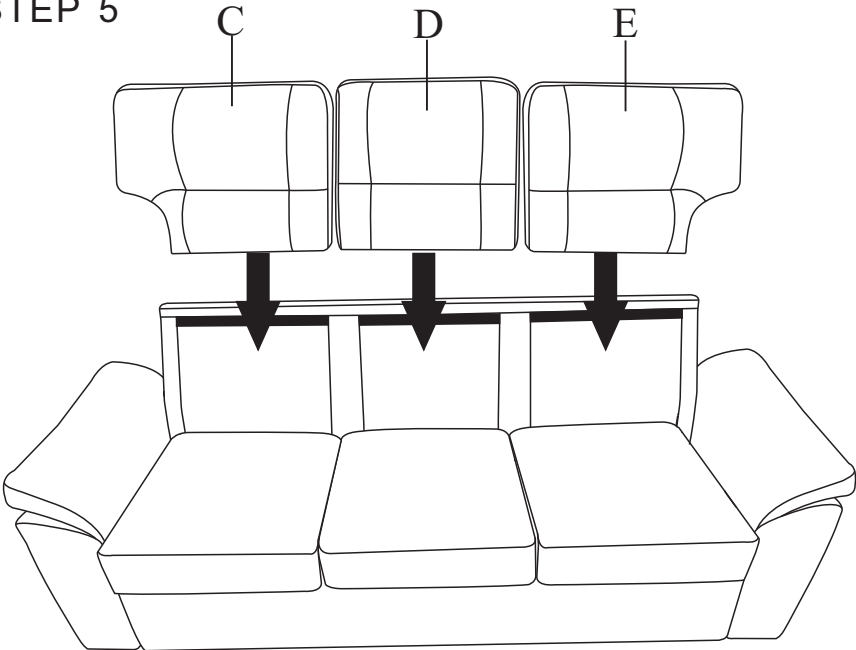

ASSEMBLY INSTRUCTIONS

STEP 6

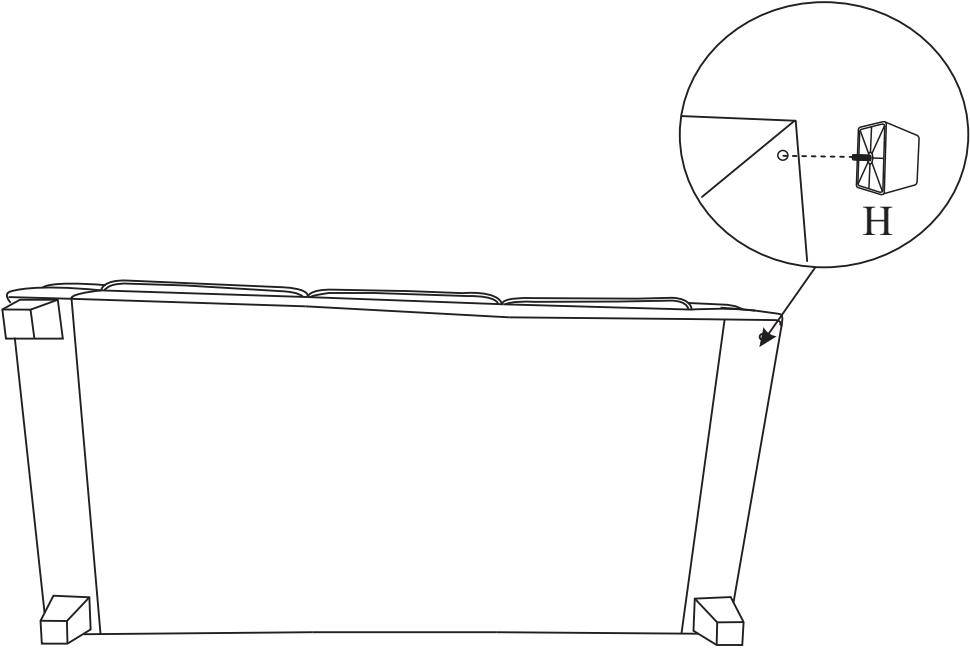

STEP 7

