

# ASSEMBLY INSTRUCTIONS

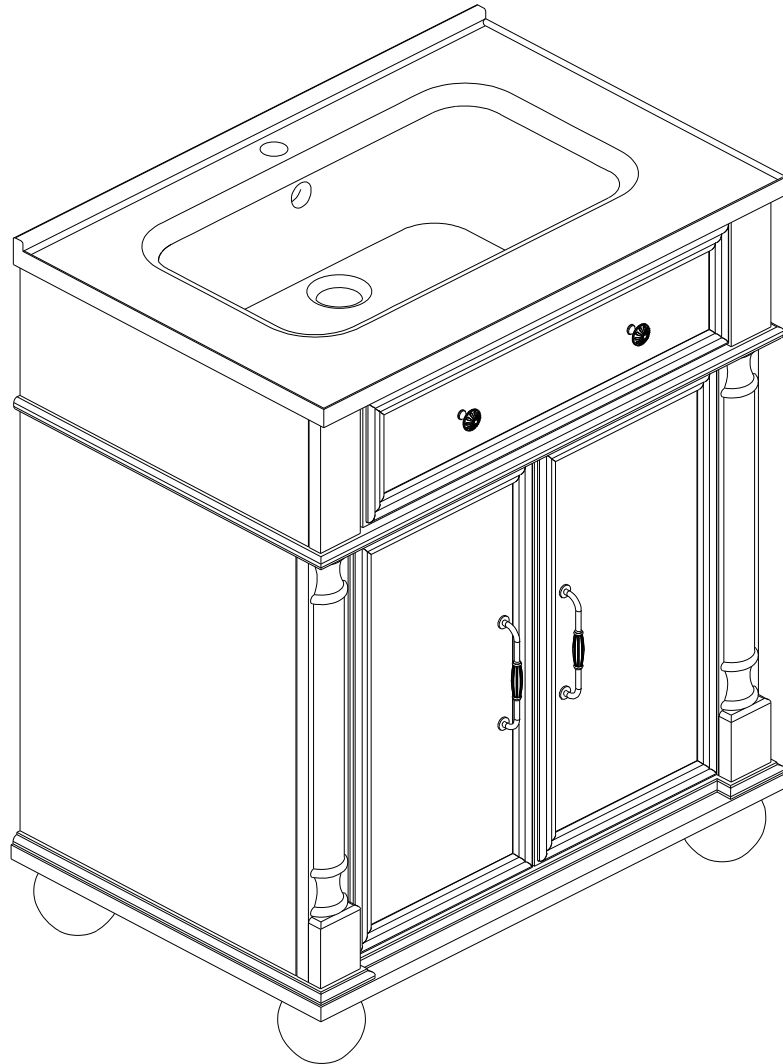

## Notice:

1. Follow the installation instructions. Please confirm all accessories are preset before installation.
2. Do not fully tighten the screws during initial assembly. Fully tighten screws only once all pieces which are correctly assembled.
3. If you encounter any problems during installation, please contact our customer service.
4. Please unbox the item from the side with an open-label and put a carpet on the floor to avoid scratching it.

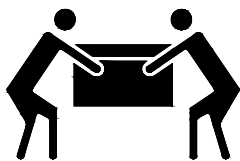

Recommended installers:2

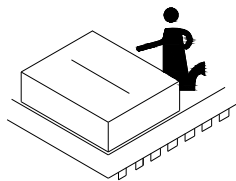

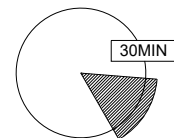

Put a carpet on the floor  
before unpacking



Estimate installation time:  
30minutes



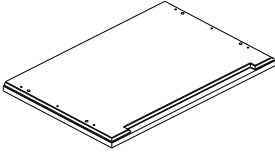
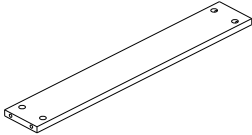
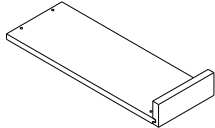
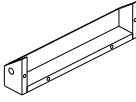
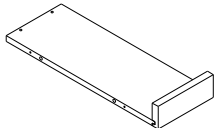
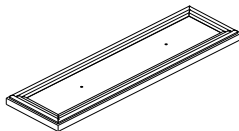
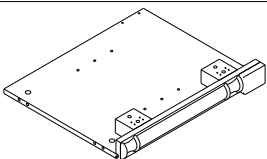
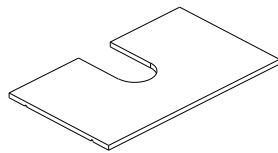
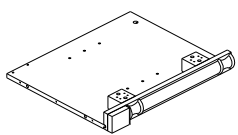
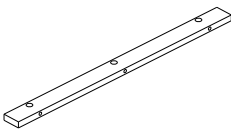
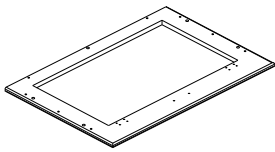
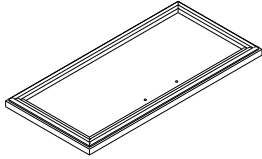
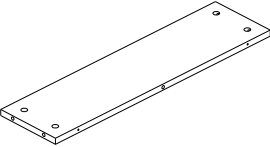
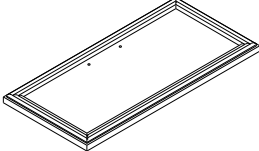
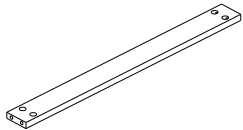







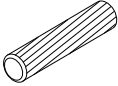

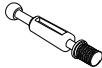
# ASSEMBLY INSTRUCTIONS

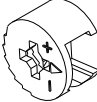
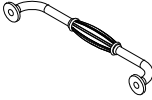
## PART LIST

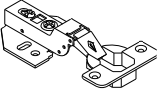
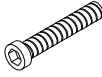
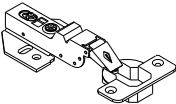
Item no.	Reference Image	Qty	Item no.	Reference Image	Qty
A		X1	I		X1
B		X1	J		X1
C		X1	K		X1
D		X1	L		X1
E		X1	M		X1
F		X1	N		X1
G		X1	O		X1
H		X1	P		X4

# ASSEMBLY INSTRUCTIONS

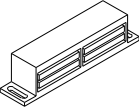
## HARDWARE LIST

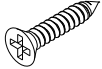
Item no.	Reference Image	Qty	Item no.	Reference Image	Qty
1	 Ø8*30mm	X13+1	10		X4
2		X23+2	11		X2
3		X23+2	12		X2
4	 Ø3.5*50mm	X14+1	13	 Ø5*3/4"	X6
5		X4	14	 Ø1/4"*2"	X4
6		X2	15		X4
7	 Ø3*14mm	X36+3	16	 Ø1/4"*1.0T*D12mm	X4
8		X1	17		X1
9	 Ø3*16mm	X2			

# ASSEMBLY INSTRUCTIONS

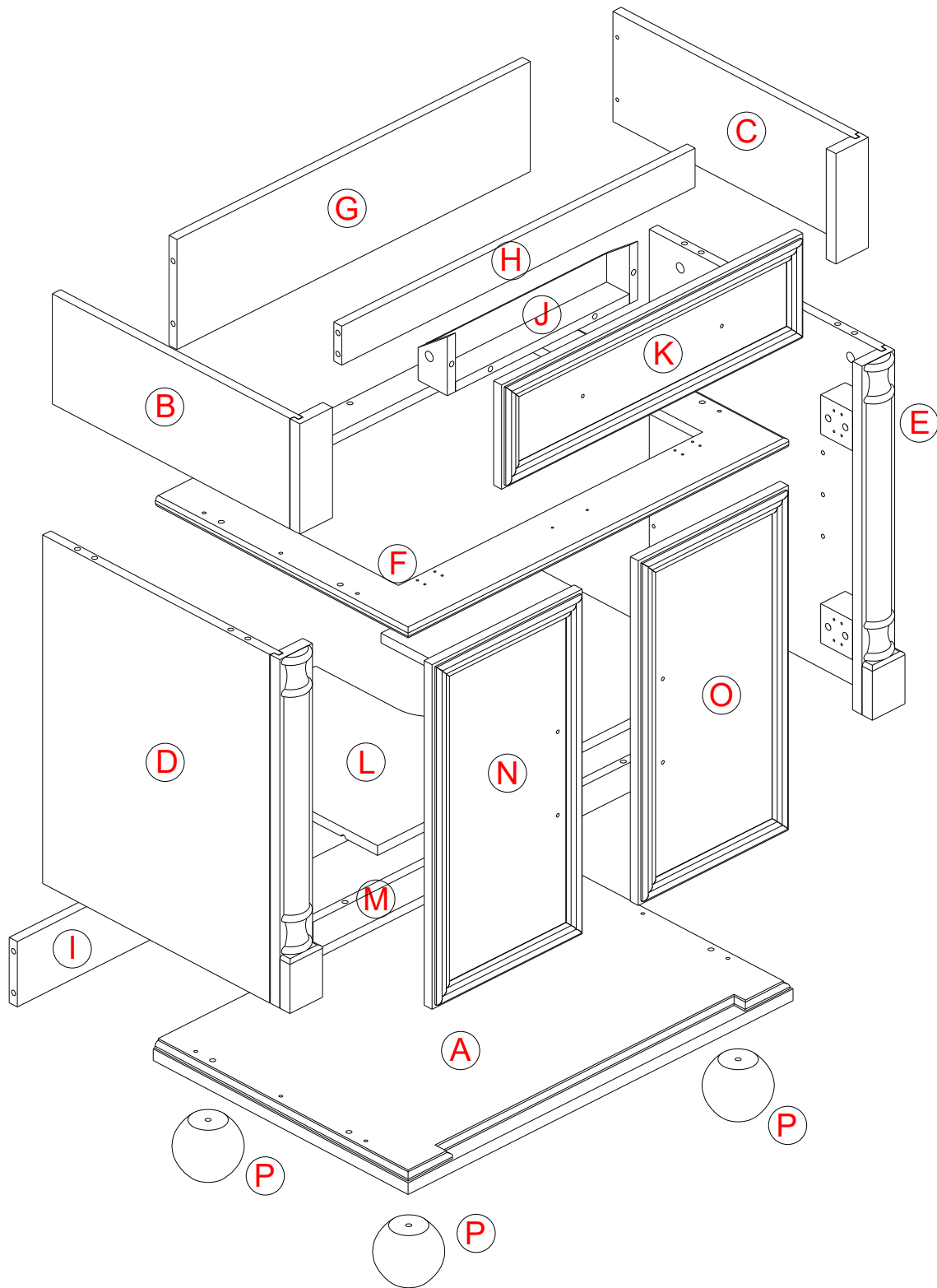

# ASSEMBLY INSTRUCTIONS

1

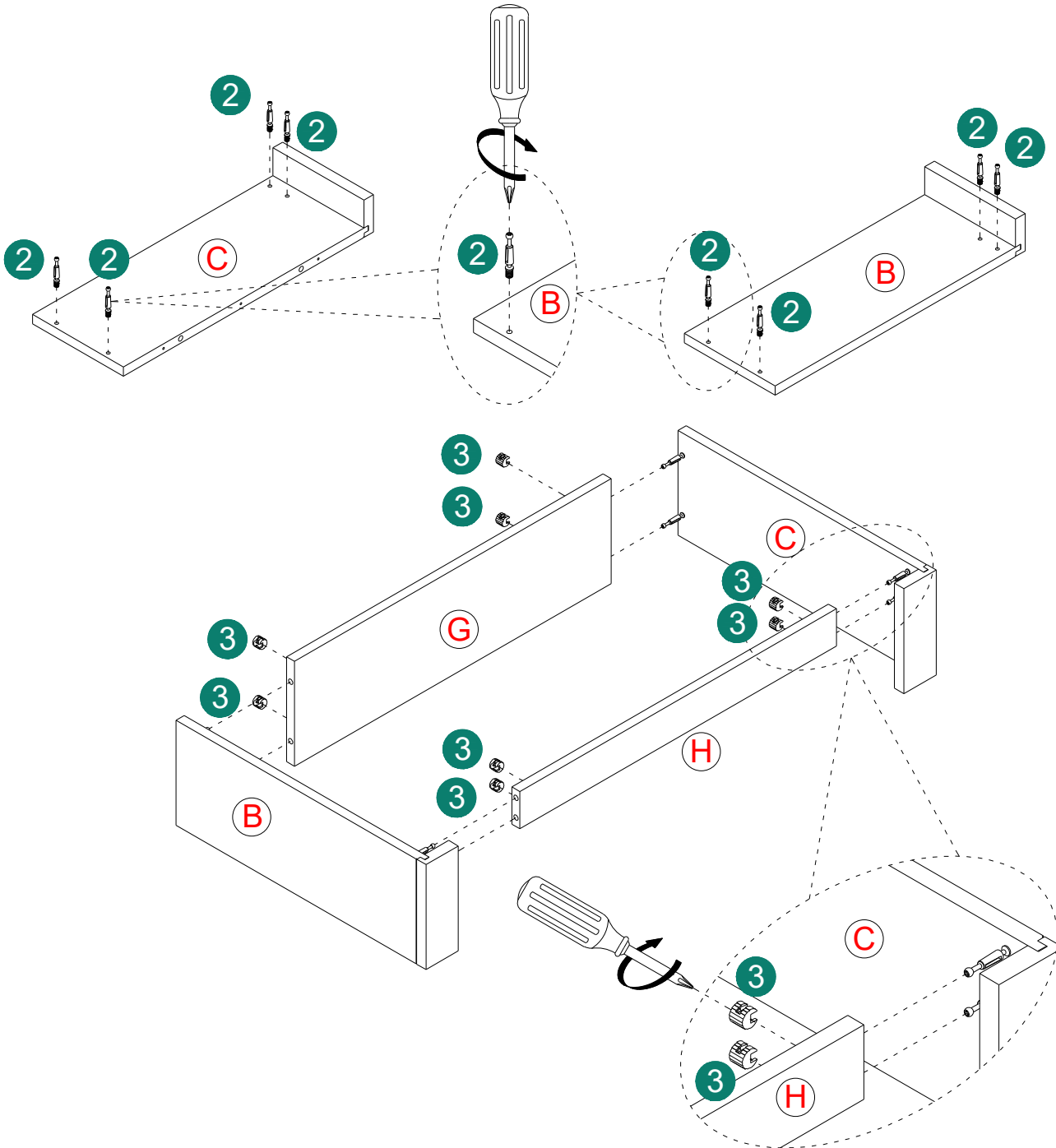
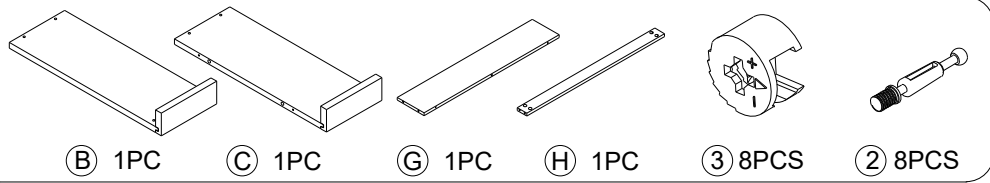

# ASSEMBLY INSTRUCTIONS

2

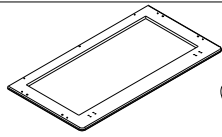

F 1PC



Ø3.5\*50mm  
4 8PCS

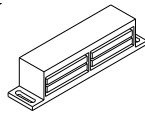

8 1PCS



Ø3\*16mm  
9 2PCS

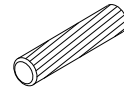

1 5PCS



2 4PCS

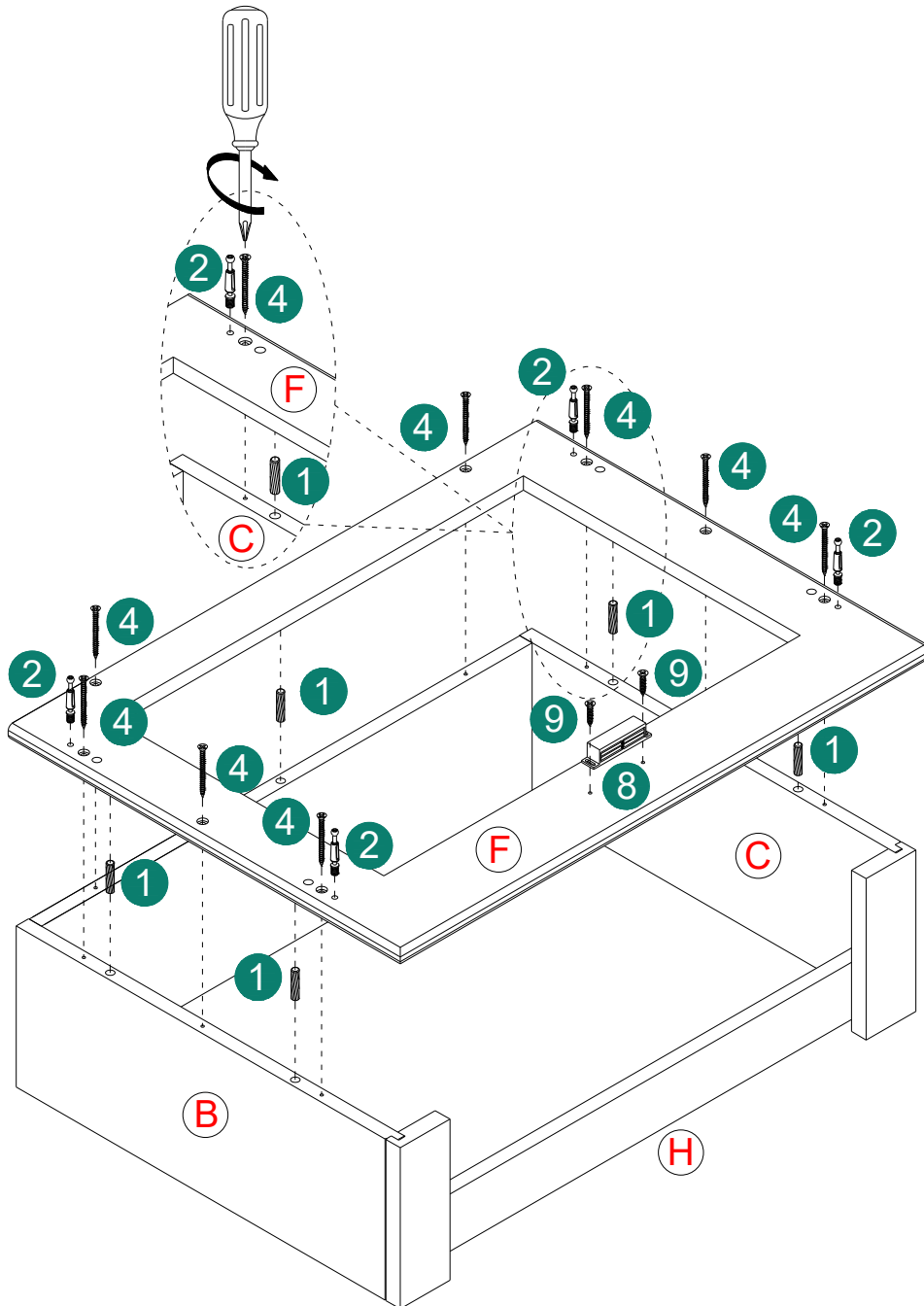

# ASSEMBLY INSTRUCTIONS

3

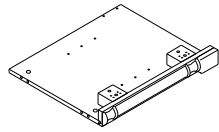

ⓓ 1PC

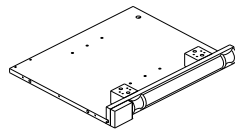

ⓔ 1PC



② 4PCS

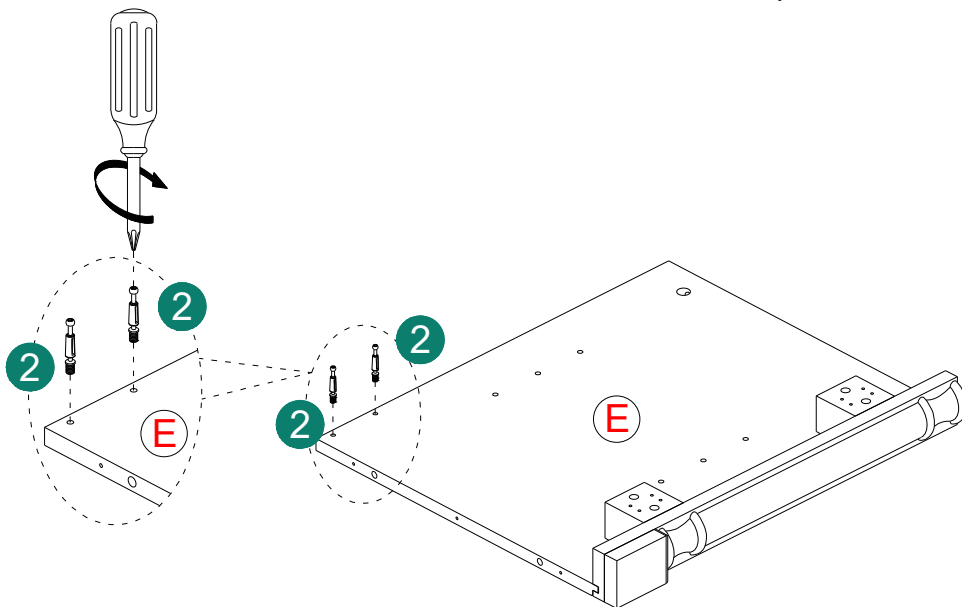
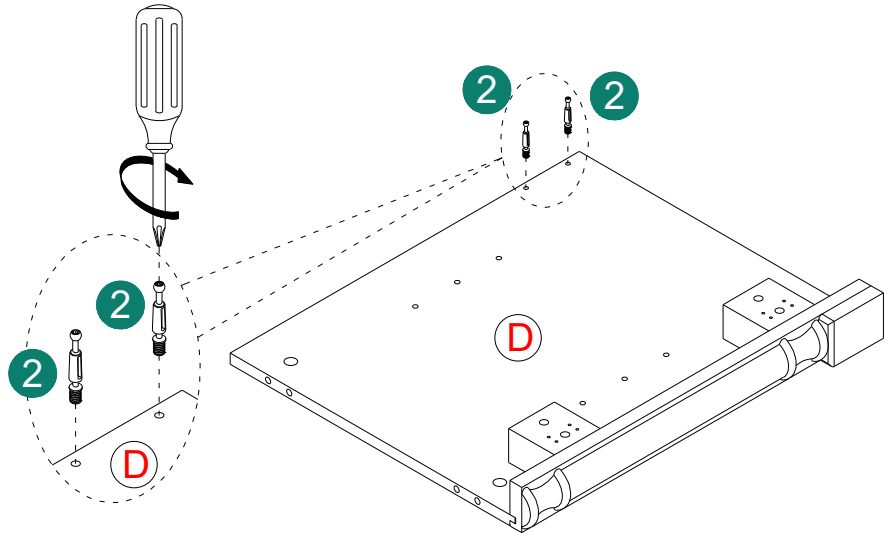

# ASSEMBLY INSTRUCTIONS

4

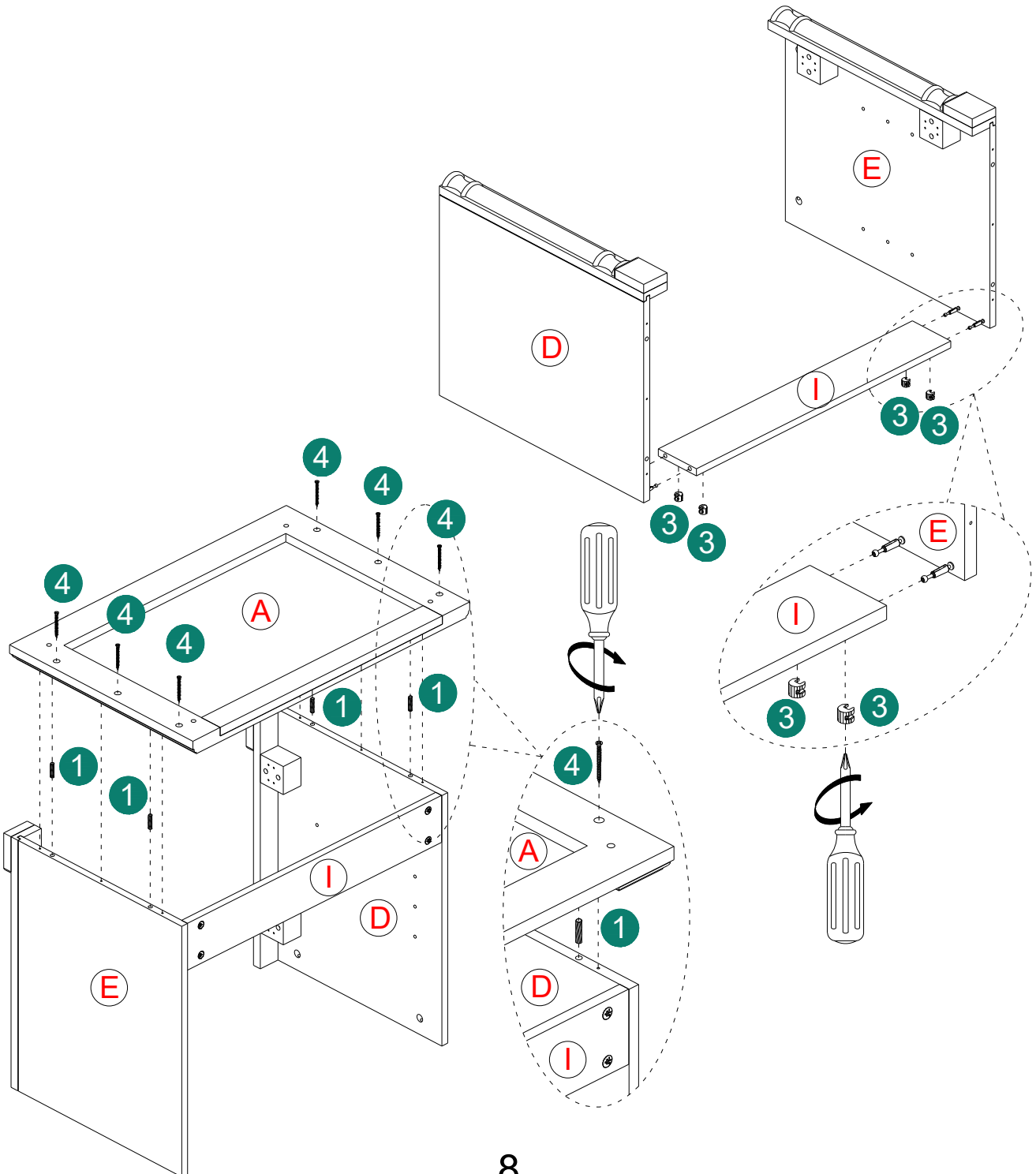
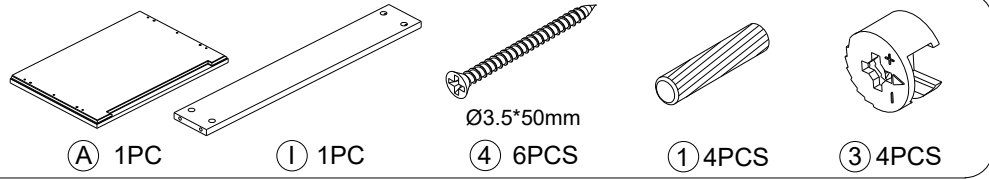

# ASSEMBLY INSTRUCTIONS

5

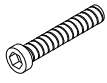

Ø1/4"×2"

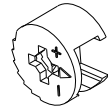
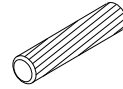

(P) 4PC

(14) 4PCS

(15) 4PCS

(16) 4PCS

(17) 1PCS

(1) 4PCS

(3) 4PCS

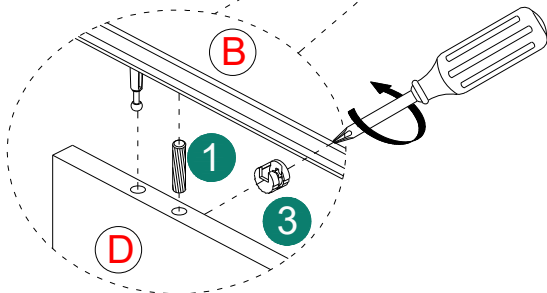
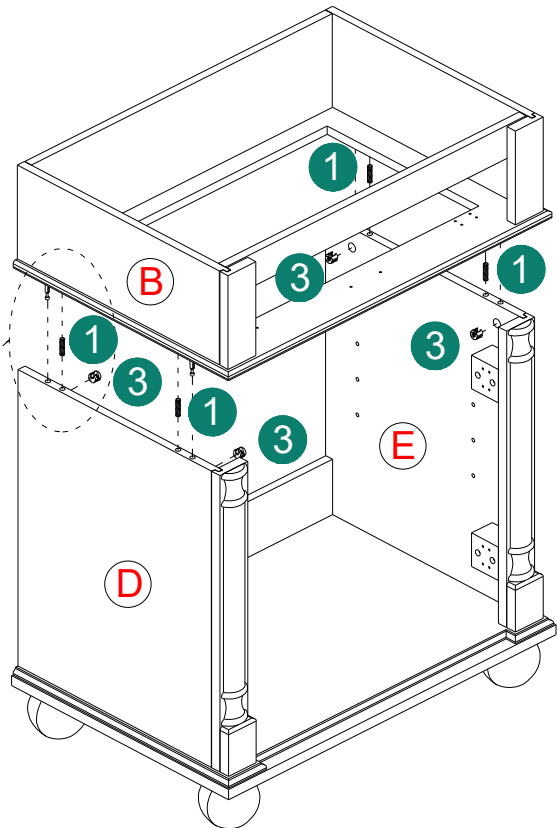
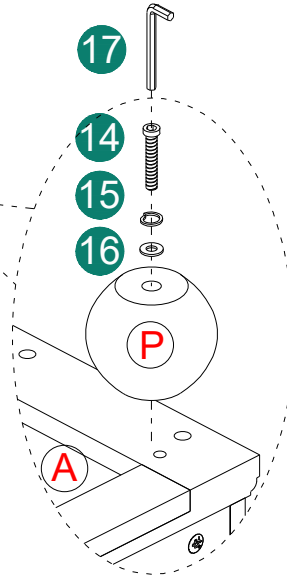
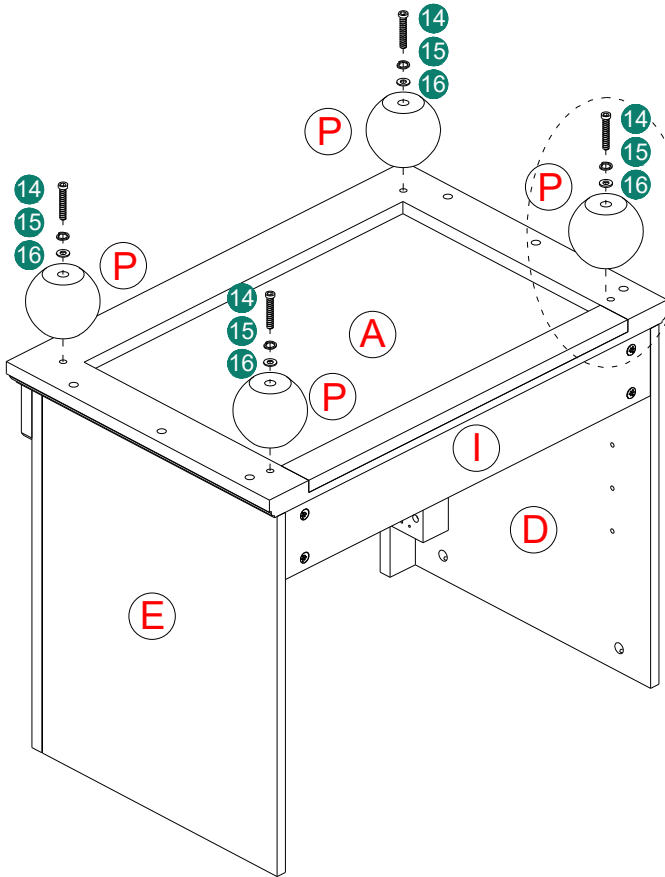

# ASSEMBLY INSTRUCTIONS

6

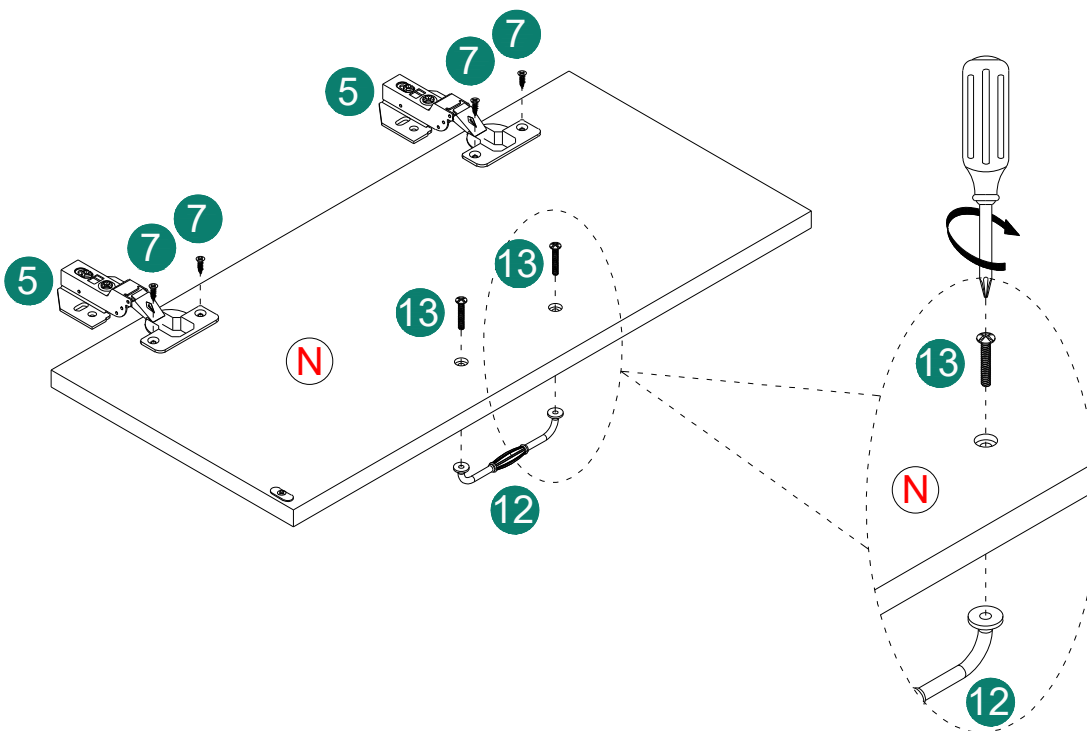
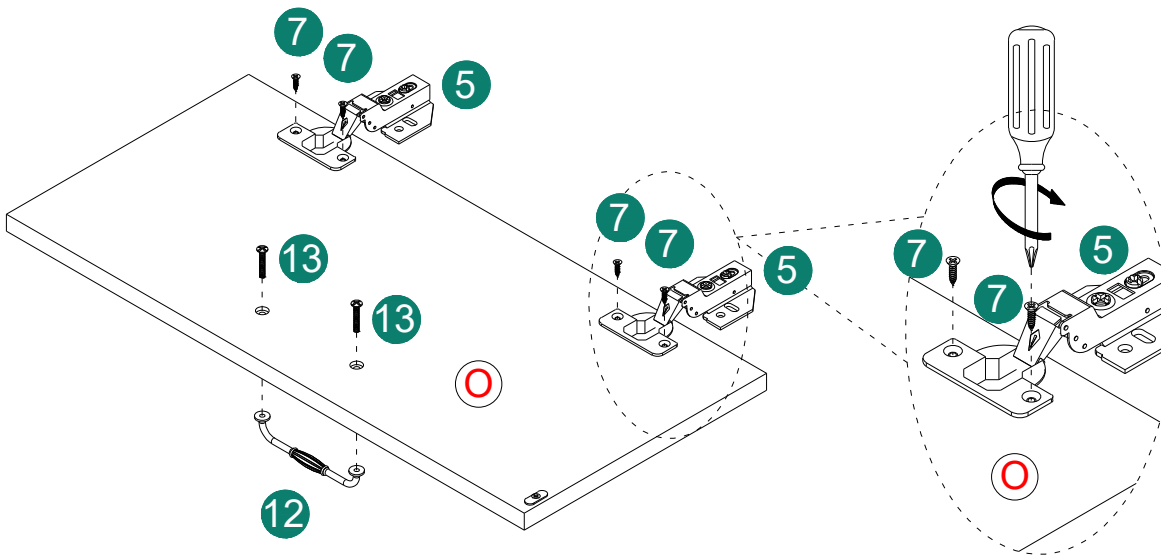
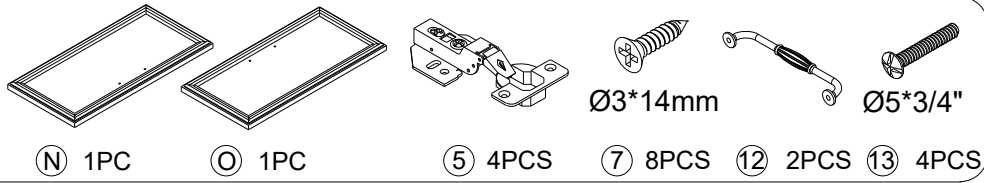

# ASSEMBLY INSTRUCTIONS

## 7

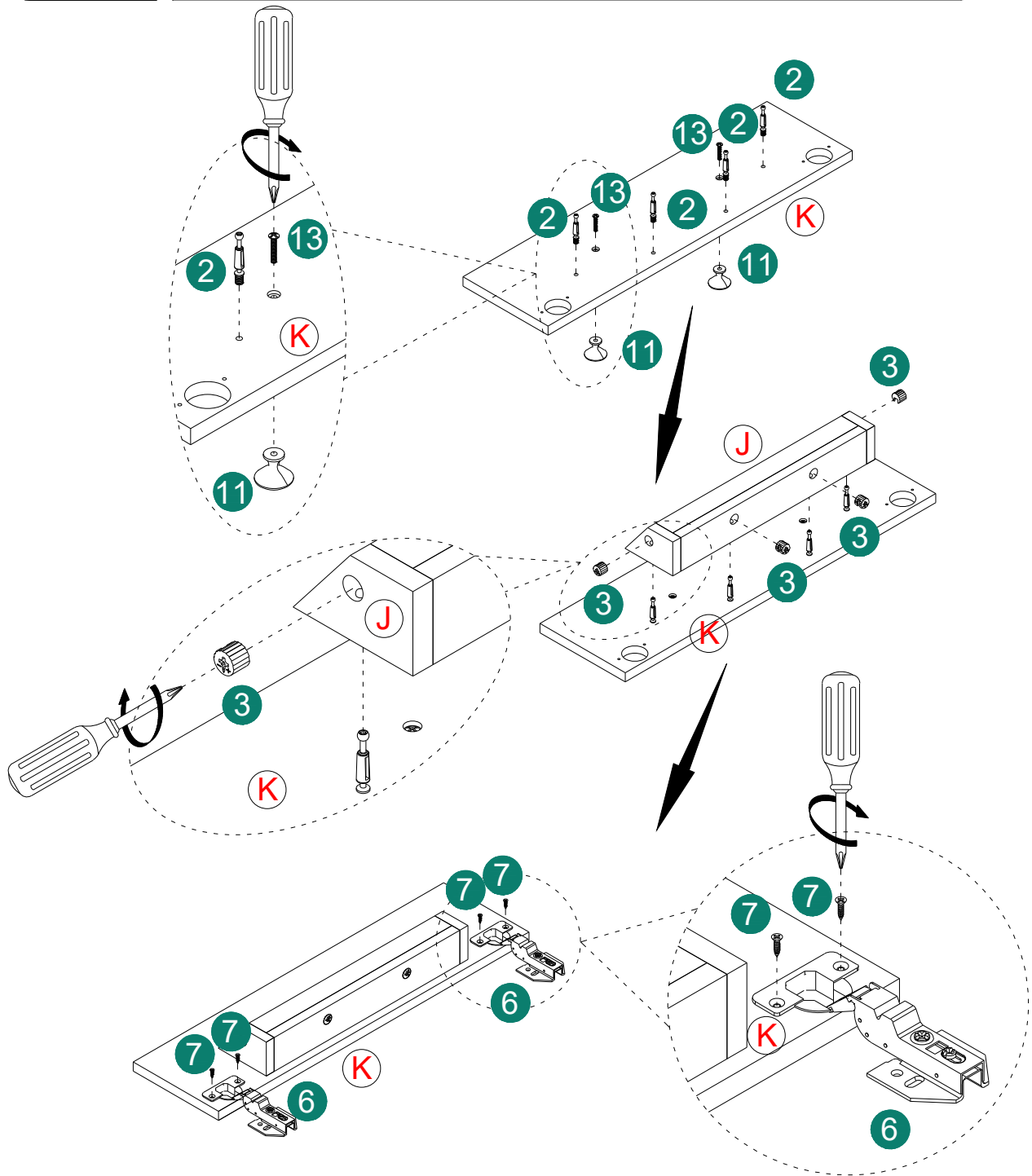
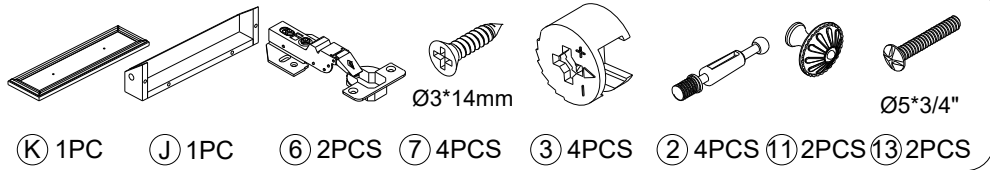



# ASSEMBLY INSTRUCTIONS

9

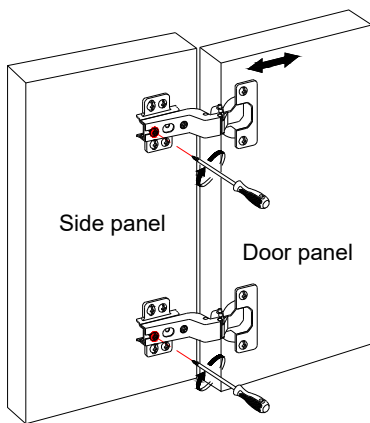

1

## Front-to-Back Direction Adjustment:

Rotate the screws on the door hinges shown in the image. The door panel can be moved front-back.

Adjustment range: 4mm

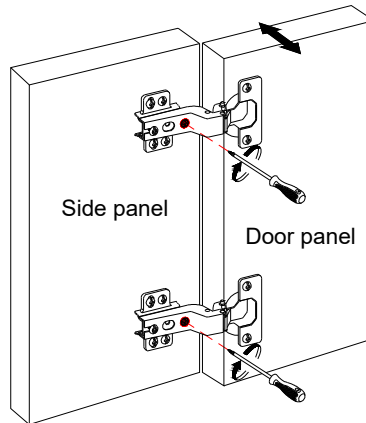

2

## Left-Right Direction Adjustment:

Rotate the screws on the door hinges shown in the image. The door panel can be moved left-right.

Adjustment range: 3mm

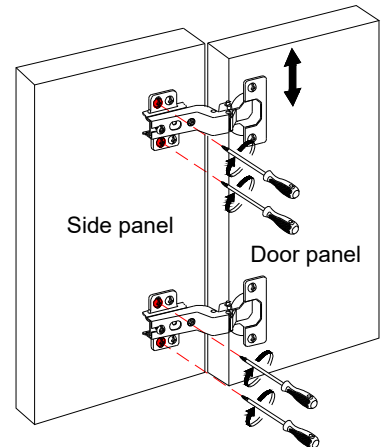

3

## Up-Down Direction Adjustment:

Rotate the screws on the door hinges shown in the image. The door panel can be moved up-down.

Adjustment range: 4mm

# ASSEMBLY INSTRUCTIONS

# 10

## Common Door Panel Issues:

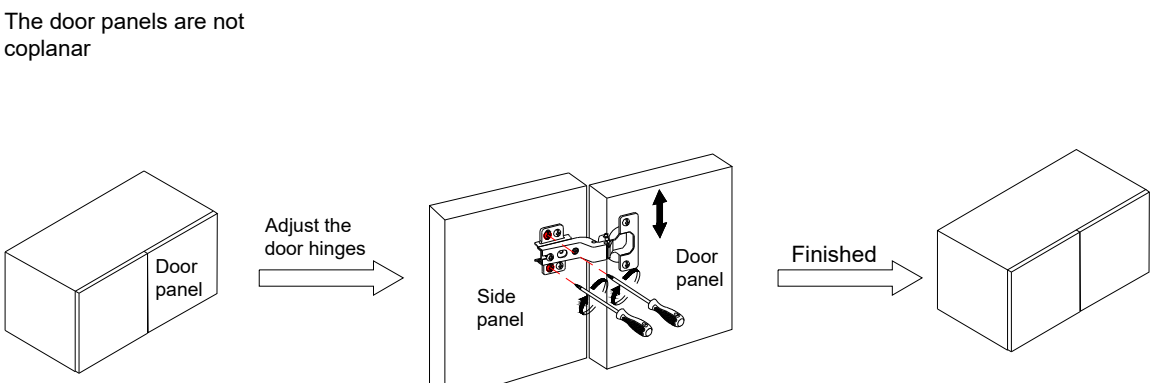
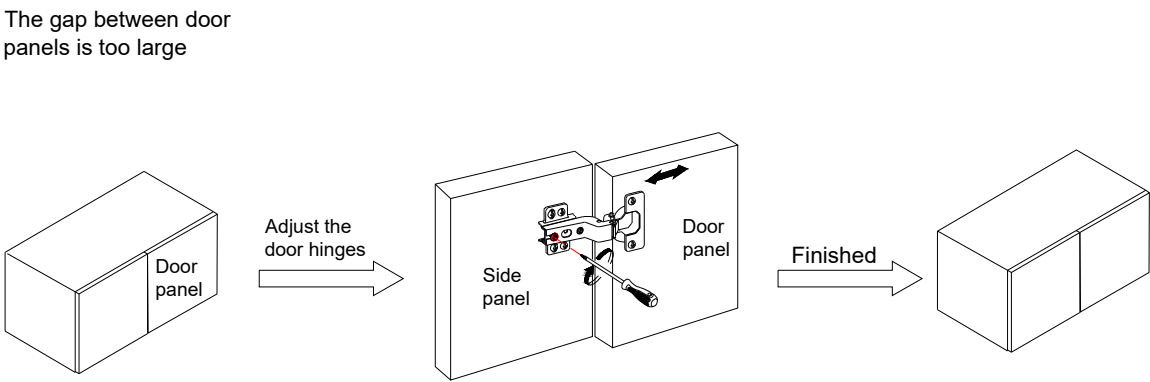
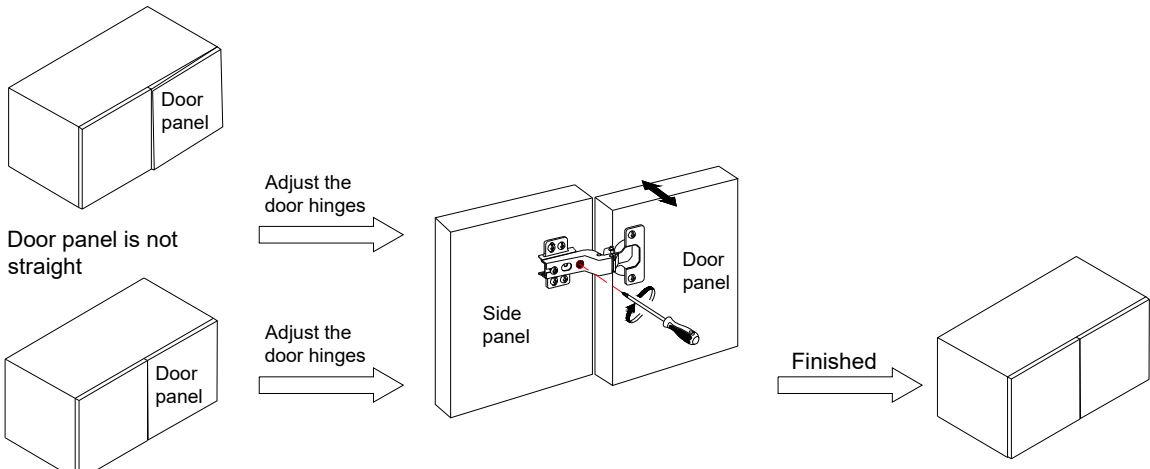

# ASSEMBLY INSTRUCTIONS

11

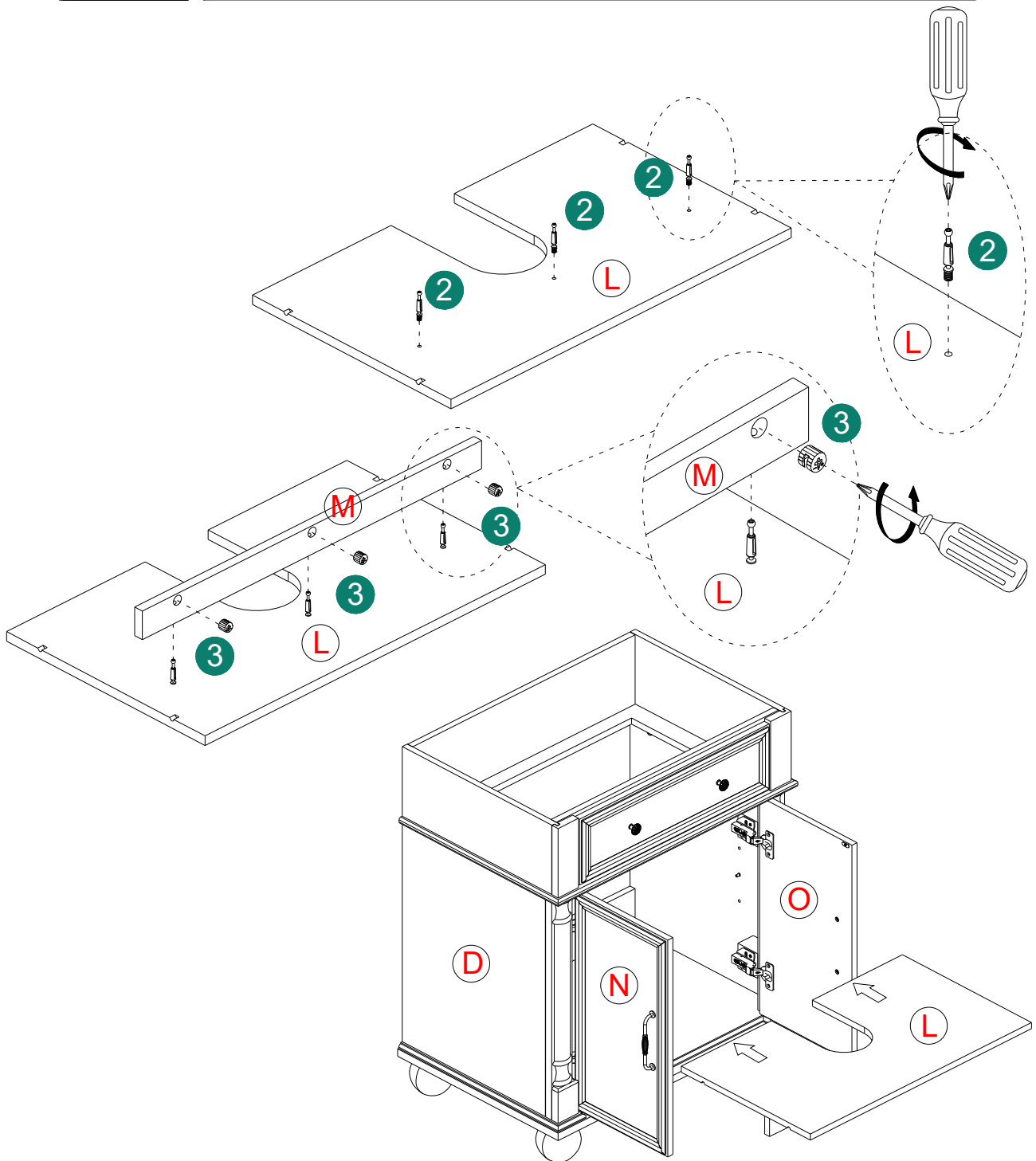

# ASSEMBLY INSTRUCTIONS

12

