

# ASSEMBLY INSTRUCTION FOR ACME FURNITURE

## MODEL#LV01442

Thank you for purchasing the quality product. Be sure to check all packing material carefully for small parts which may have come loose inside the carton during shipment. Separate, identify and count all parts and metal hardware. Compare with all parts list to be sure all parts are present. If any part(s) are missing or damaged, please contact your local furniture dealer. For efficient and speedy service, please indicate the model number and code letter of part(s) needed.

**\*\*\*Do not fully tighten screws until fully assembled\*\*\***

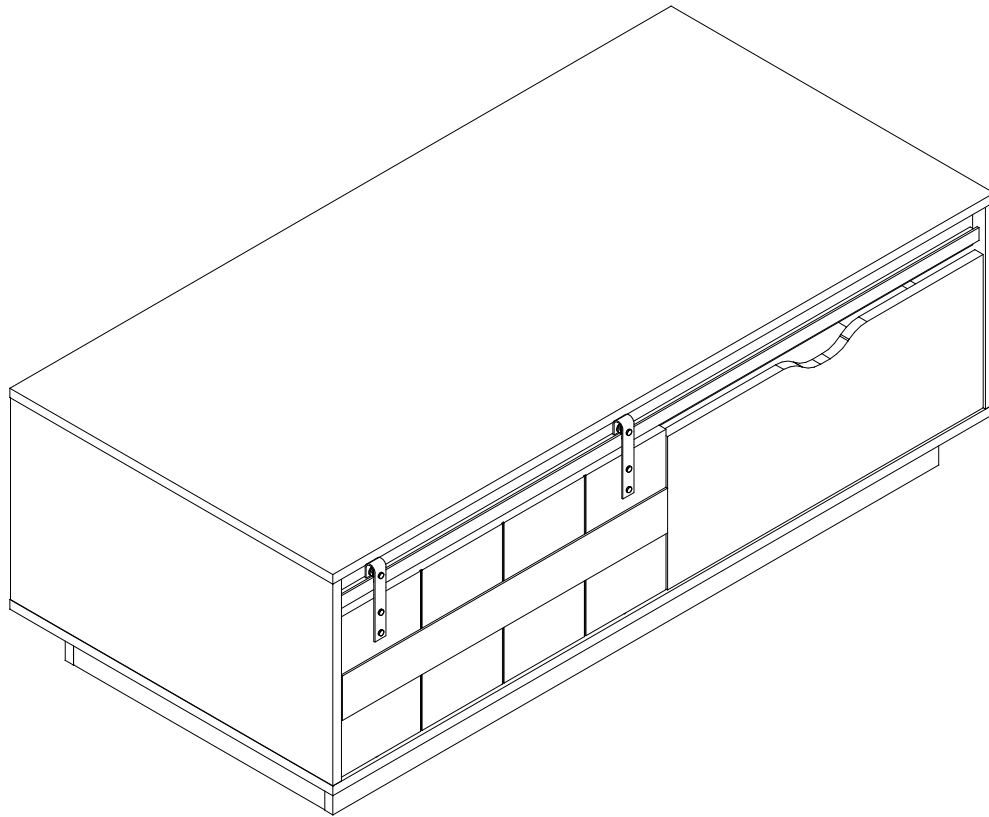

### Attention:

**\*\*\*Some number parts listed on the instruction sheet may not be in parts bag as they may already be assembled. Carefully check parts and packing materials prior to ordering replacements.**

# General Assembly Guidelines

- I. Ensure that all parts and hardware are available before beginning assembly.
- II. Follow each step carefully to ensure the proper assembly of this product.
- III. Two people are recommended for ease in the assembly of this product.
- IV. The three main types of hardware used to assemble this product are: wood dowels, screws and bolts.
- V. The provided glue is to secure wood dowels in place. When first inserting dowels, locate the appropriate hole for the dowel, place a small amount of glue in the hole and insert the dowel. Wipe away excess glue immediately.

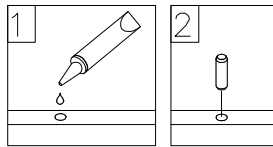

In future assembly steps when dowels are necessary to attach assembly parts together, place a small amount of glue on the end of the dowel before attaching parts together. Wipe away excess glue immediately.

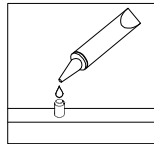



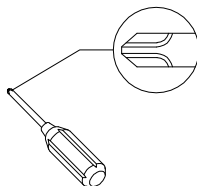

- VI. A Phillips head screwdriver is required for the assembly of this product.

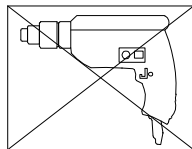



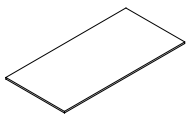

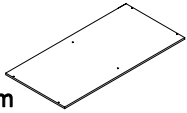
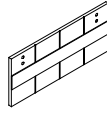
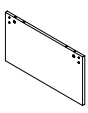
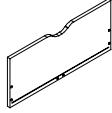
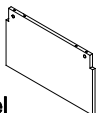
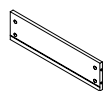
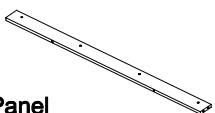
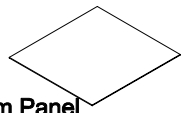

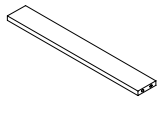
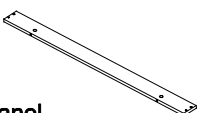





- VII. Power tools should not be used to assemble this product.



# COMPONENT PARTS

DESCRIPTION	PART NAME	QTY(PCS)	DESCRIPTION	PART NAME	QTY(PCS)
①	Table Top 	1	⑧	Support Panel 	2
②	Table Bottom 	1	⑨	Door 	2
③	Side Panel 	2	⑩	Drawer Front Panel 	2
④	Middle Side Panel 	1	⑪	Drawer Side Panel 	2
⑤	Support Panel 	2	⑫	Drawer Bottom Panel 	1
⑥	Metal Tube 	2	⑬	Support Panel 	1
⑦	Support Panel 	2			

## Hardware List

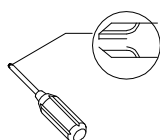

A	 Ø8x30mm	Wooden dowel	28 pcs	G	 Ø1/4"x25mm	Bolt	4 pcs
B	 Ø6x35mm	Cam bolt	36 pcs	H	 Ø1/4"x12mm	Bolt	8 pcs
C	 Ø15x12mm	Cam lock	36 pcs	I		Glue tube	1 pcs
D		Sticker	8 pcs	J		Hanging wheel	4 pcs
E	 Ø6x50mm	Screw	6 pcs	K		Plastic wedge	8 pcs
F	 4mm	Allen Key	1 pcs	L	 Ø3x18mm	Screw	8 pcs



Philips head screwdriver required for assembly  
(not included)



*The hardware quantities listed above are required for proper assembly.  
Some extra hardware may also have been included.*

# Step 1

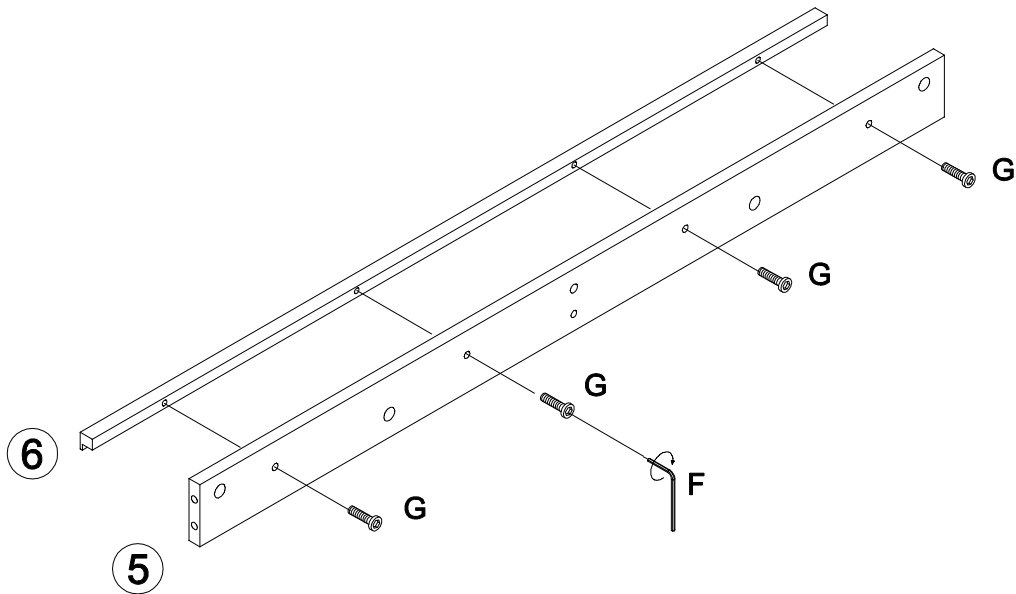
<b>F x 1</b>  4mm	<b>G x 4</b>  Ø1/4"x25mm
--	--



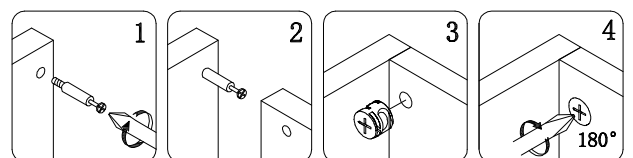
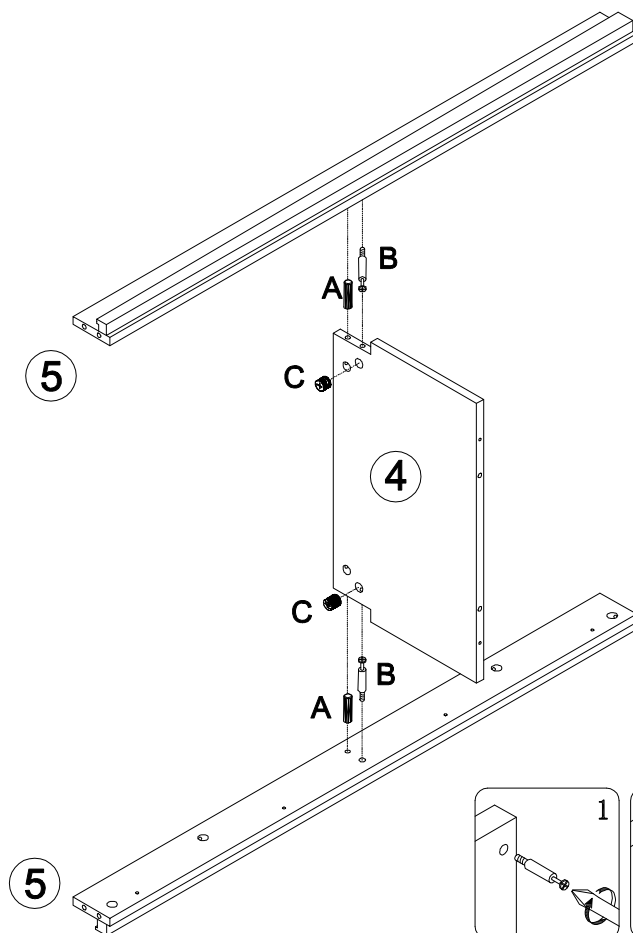

# Step 2

<b>A x 2</b>  Ø8x30mm	<b>B x 2</b>  Ø6x35mm	<b>C x 2</b>  Ø15x12mm
--	--	---



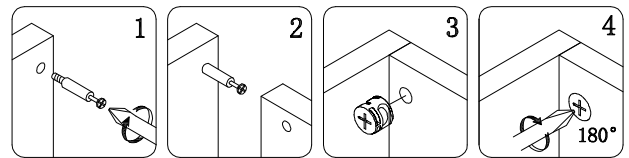
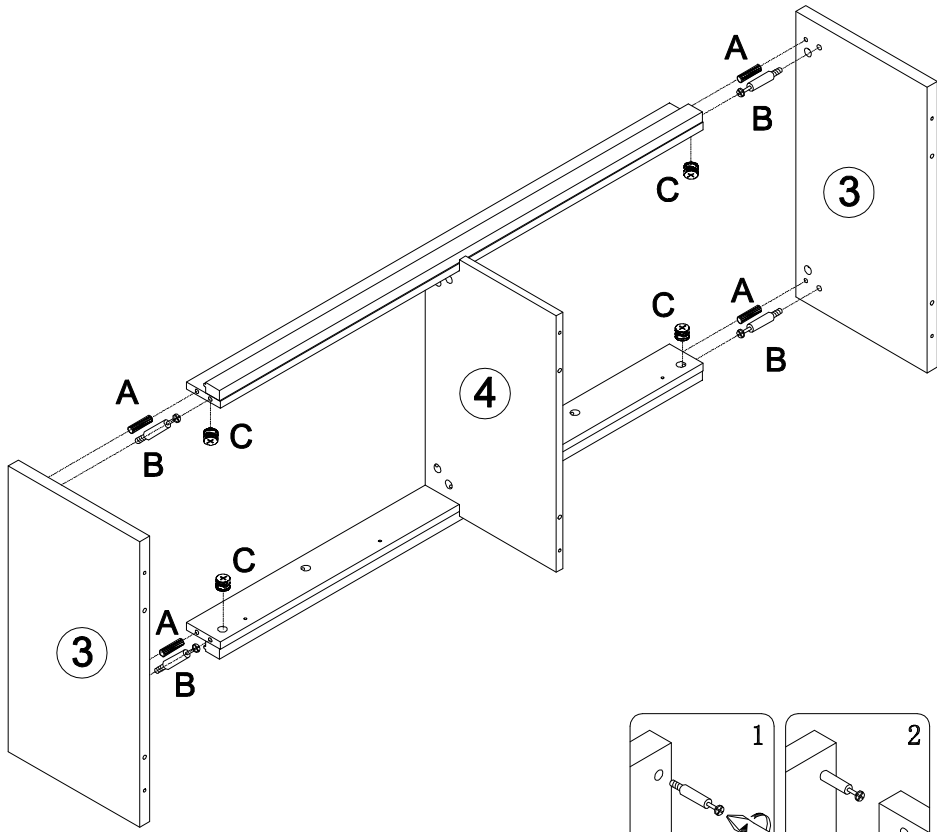

# Step 3

<b>A x 4</b>	<b>B x 4</b>	<b>C x 4</b>
		
Ø8x30mm	Ø6x35mm	Ø15x12mm



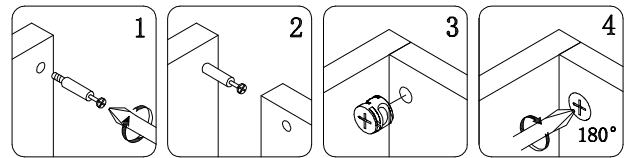
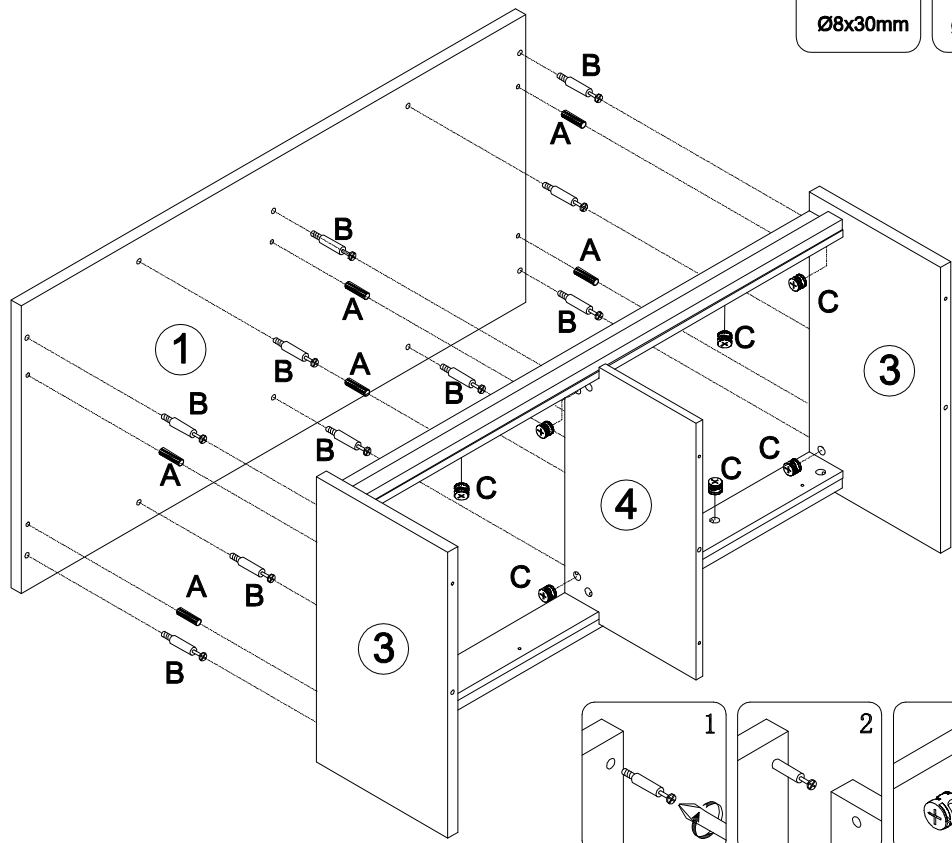

# Step 4

<b>A x 6</b>	<b>B x 10</b>	<b>C x 10</b>
		
Ø8x30mm	Ø6x35mm	Ø15x12mm



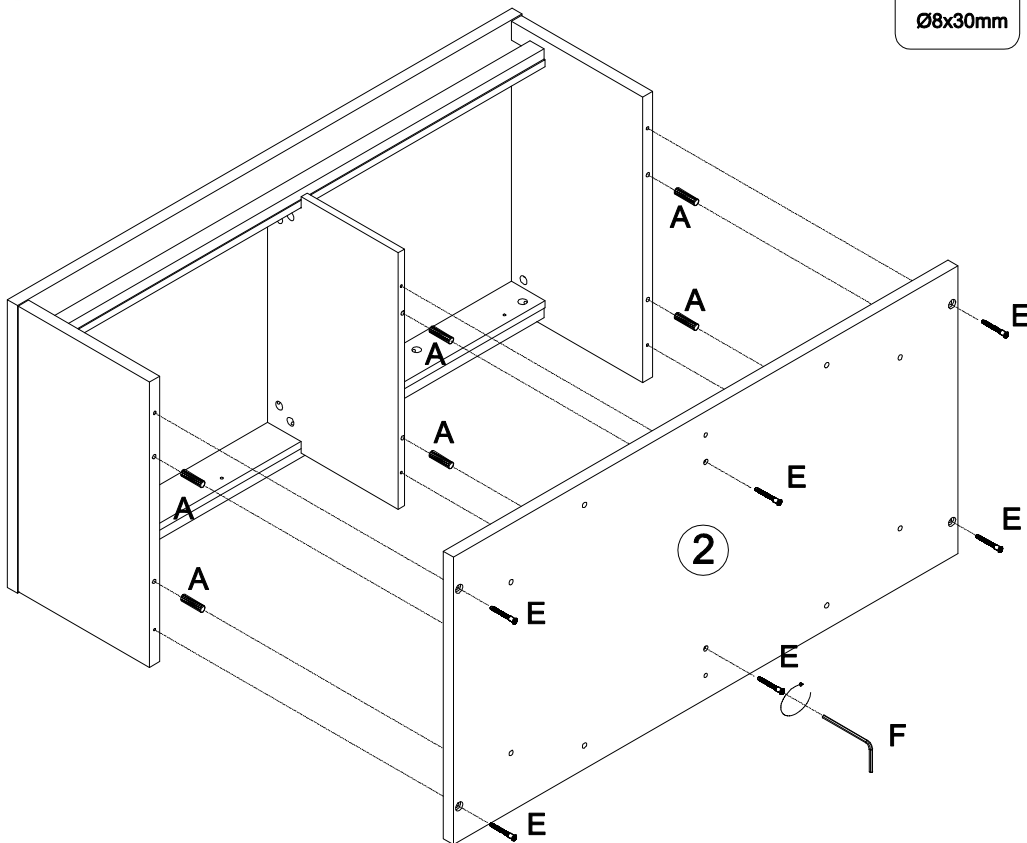

# Step 5

<b>A x 6</b>	<b>E x 6</b>	<b>F x 1</b>
		
Ø8x30mm	Ø6x50mm	4mm



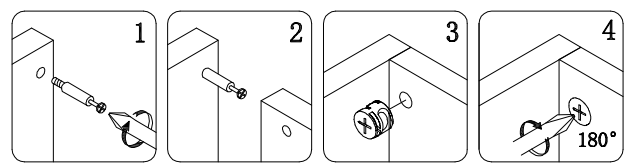
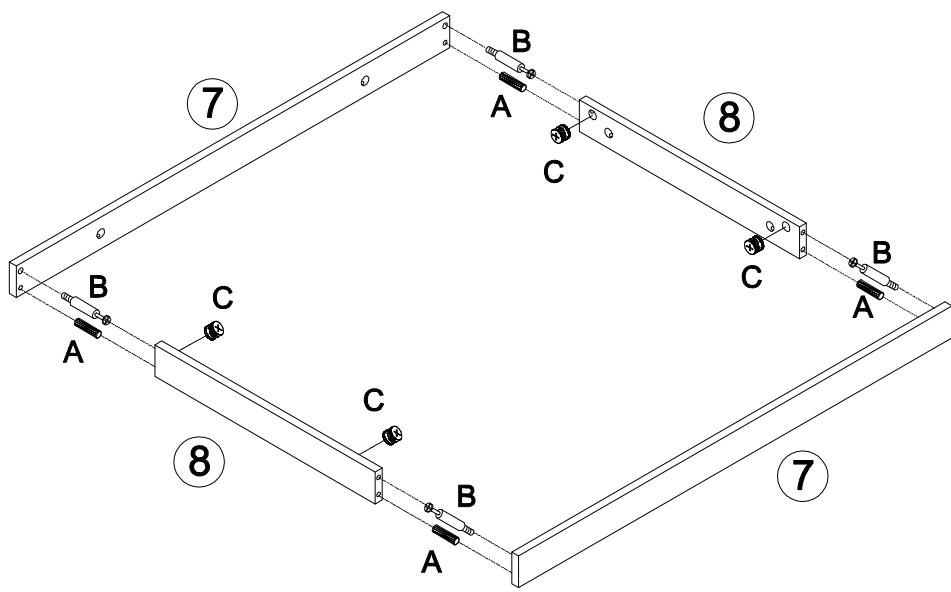

# Step 6

<b>A x 4</b>	<b>B x 4</b>	<b>C x 4</b>
		
Ø8x30mm	Ø6x35mm	Ø15x12mm



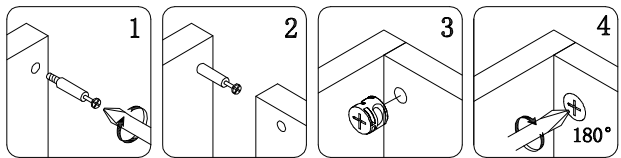
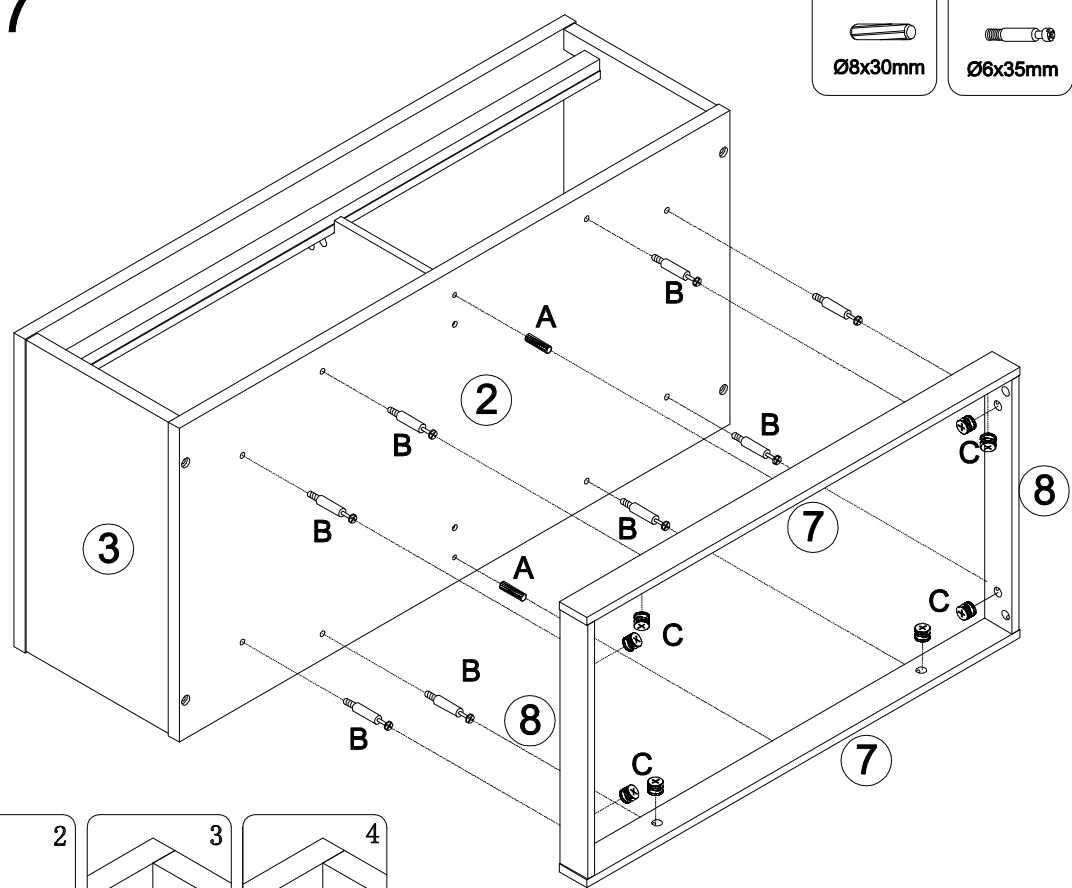

# Step 7

<b>A x 2</b>  Ø8x30mm	<b>B x 8</b>  Ø6x35mm	<b>C x 8</b>  Ø15x12mm
--	--	---



# Step 8

<b>B x 4</b>  Ø6x35mm	<b>C x 4</b>  Ø15x12mm
--	---

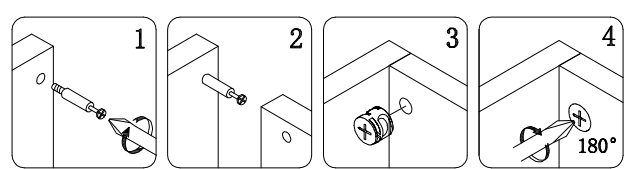
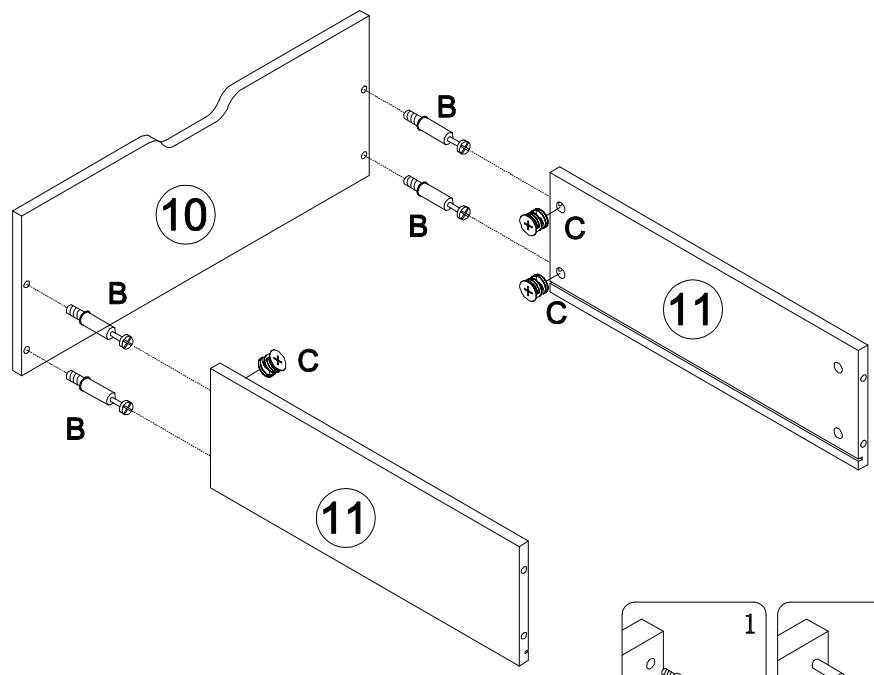

# Step 9

A x 2

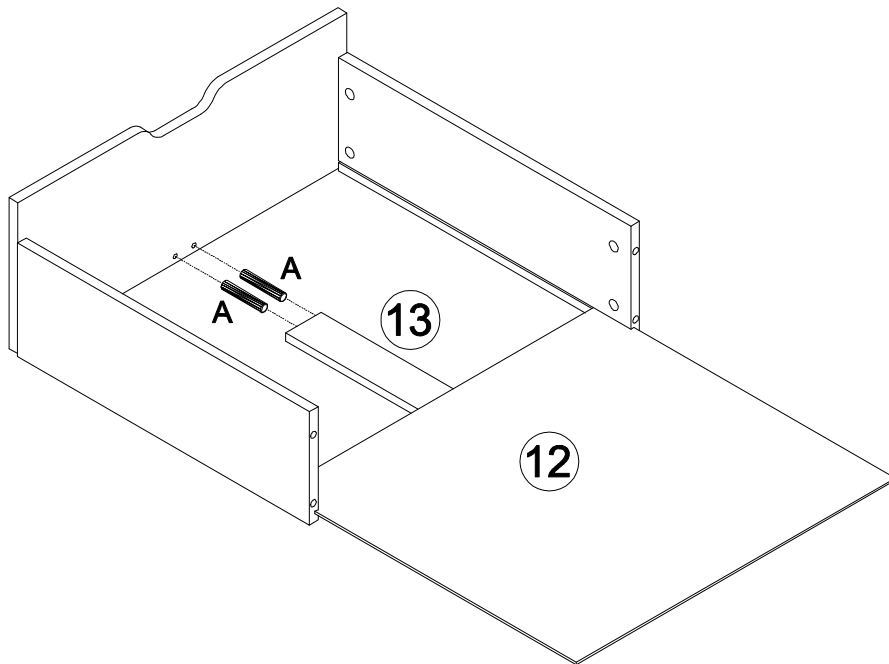

# Step 10

A x 2



D x 8





B x 4

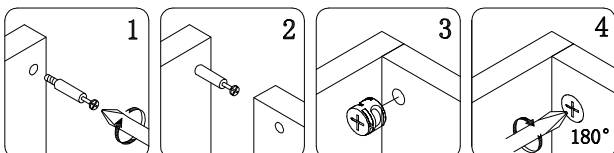
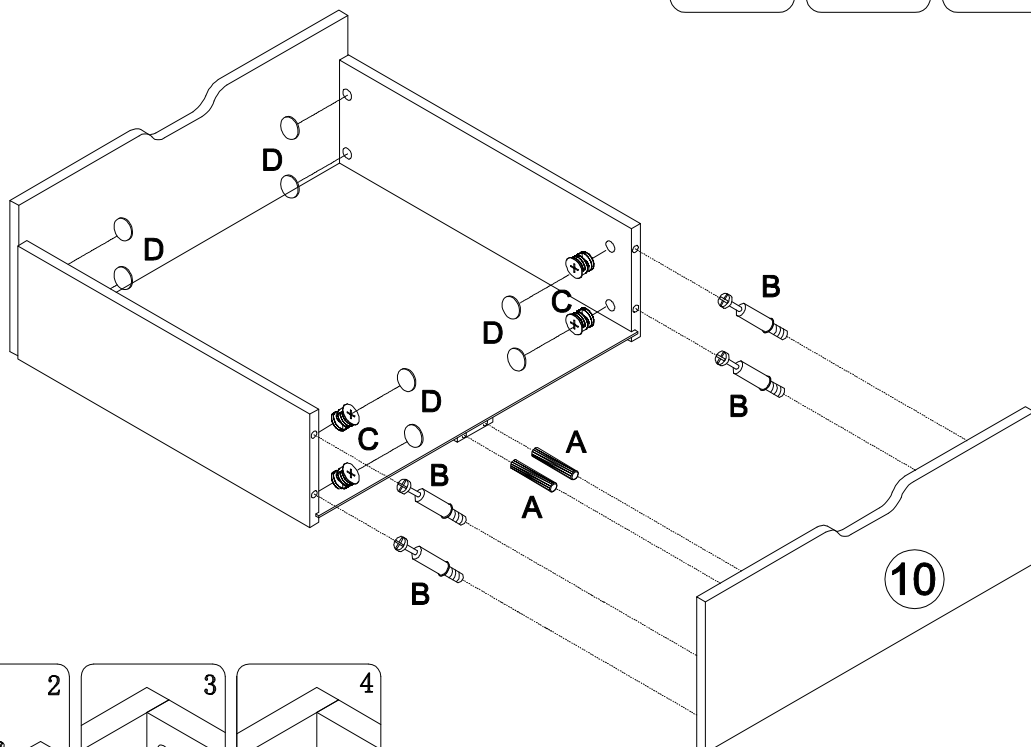

C x 4



# Step 11

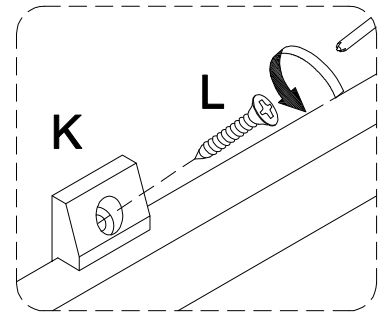
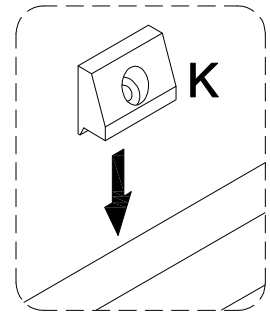
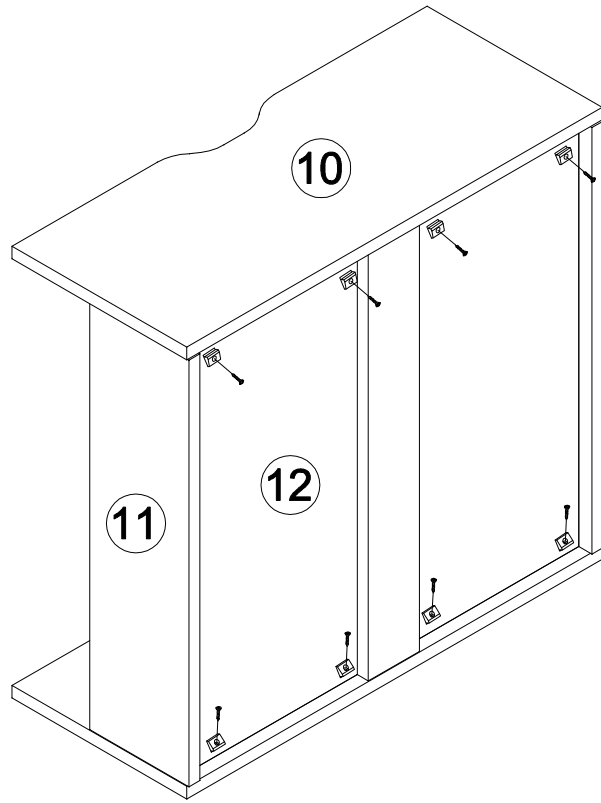

<b>K x 8</b> 	<b>L x 8</b>  Ø3x18mm
---	--

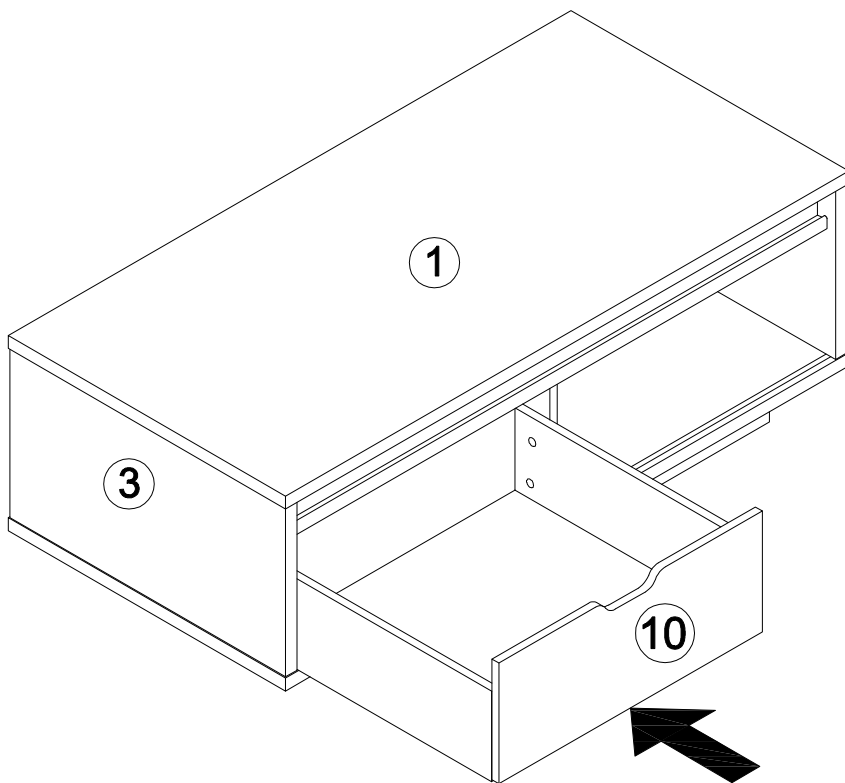

# Step 12



# Step 13

<b>F x 1</b>  4mm	<b>H x 8</b>  Ø1/4"x12mm	<b>J x 4</b> 
--	---	---

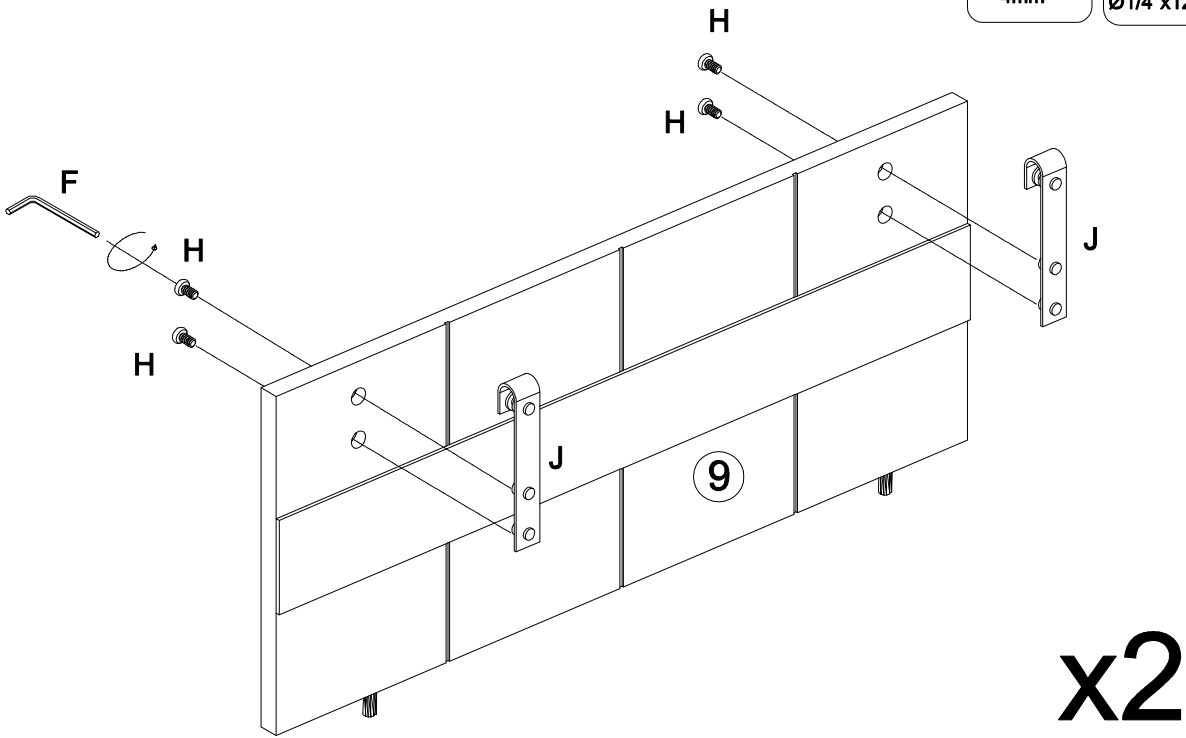

# Step 14

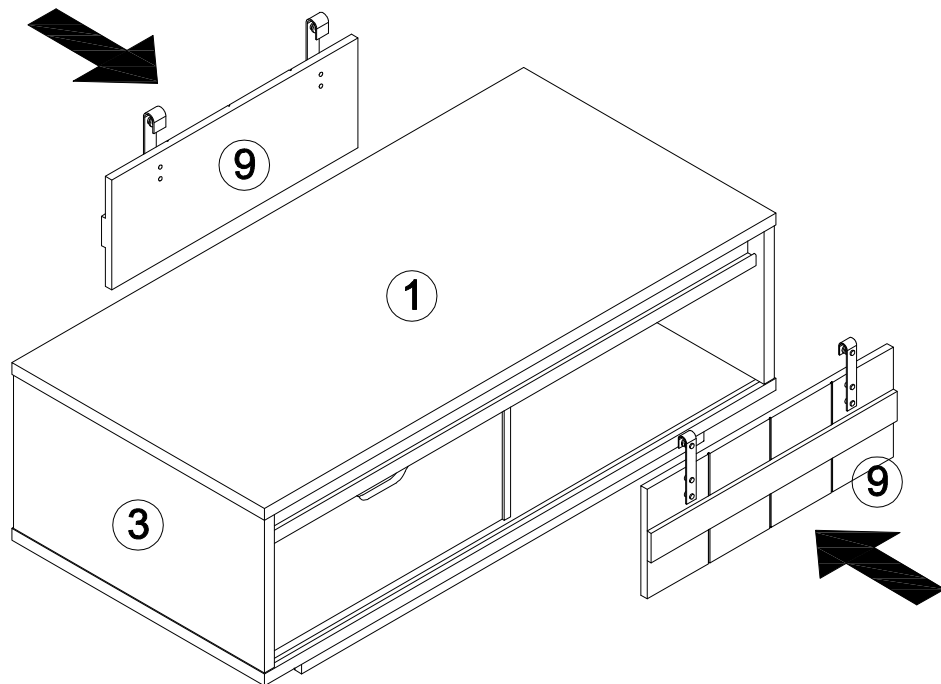

# Step 15

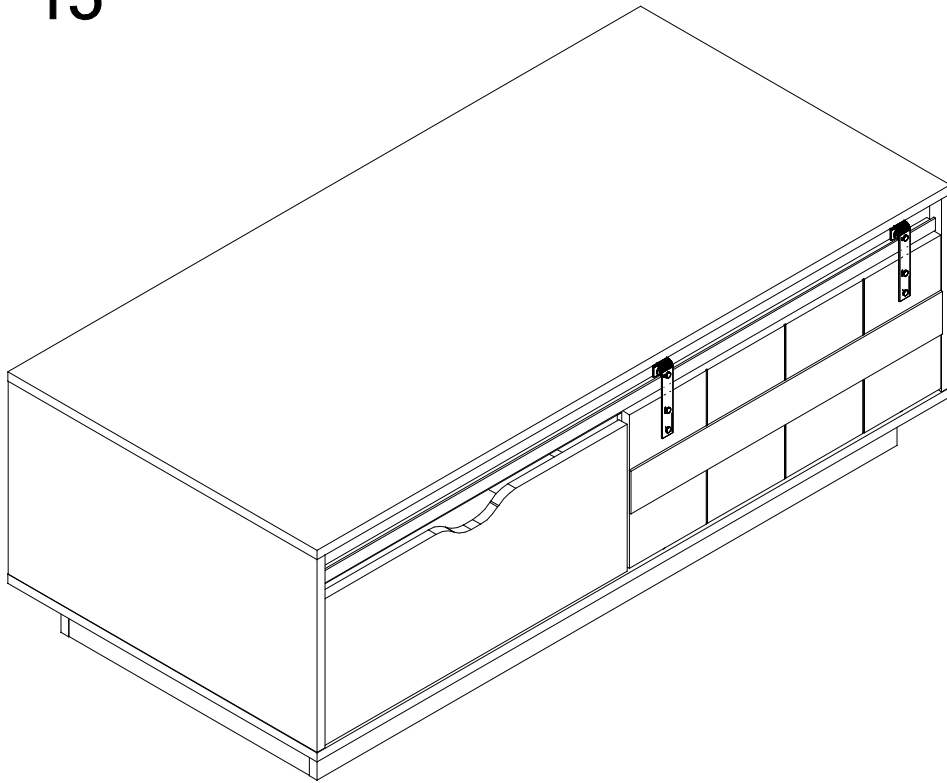

OR

