

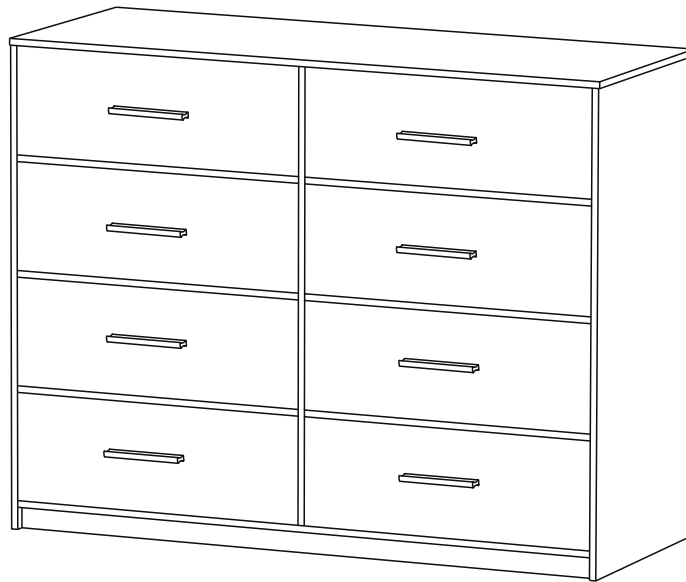

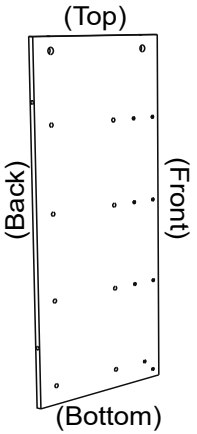

ASSEMBLY INSTRUCTIONS

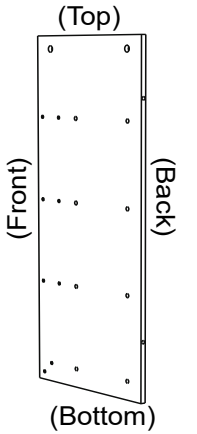

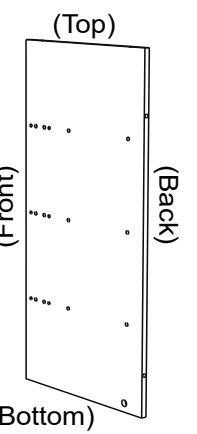
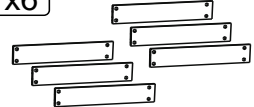
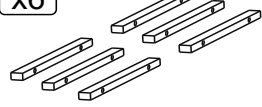
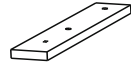

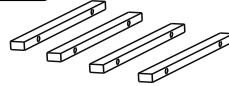
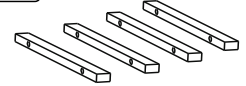
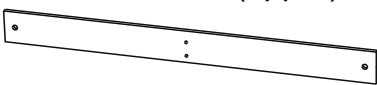
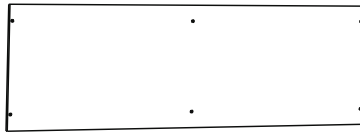
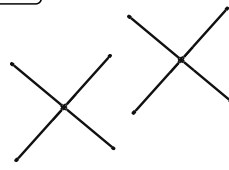
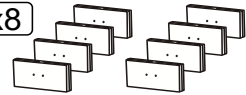



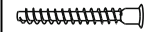

Thank you for purchasing our product!

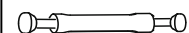

MAIN PARTS LIST

A Right side panel 	B Left side panel 	C Middle panel 	D Back supports x6 	E Middle supports x6 
		F Bottom support (upper) 	G Bottom support (lower) 	
		H Left supports x4 	I Right supports x4 	
J Bottom base (upper) 	L Top panel 		M Cross bars x2 	N Drawers x8 
K Bottom base (lower) 			O Drawer bottoms x8 	

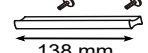

HARDWARE LIST

PART	QTY	SIZE / DESCRIPTION	ITEM
1	4	M7x40mm	 <small>mm 10 20 30 40 50 60</small>
2	23	M6x40 Bolt (Minifix)	 <small>mm 10 20 30 40 50 60</small>
3	35	Ø15x10mm Cam lock (minifix)	 <small>mm 10 20 30 40 50 60</small>
4	6	M6x63	 <small>mm 10 20 30 40 50 60</small>
5	6	M6 Nut cap	
6	6	M6x48 Double-Bolt (Minifix)	 <small>mm 10 20 30 40 50 60</small>
7	6	Ø8x40mm	 <small>mm 10 20 30 40 50 60</small>
8	8	M4x25mm	 <small>mm 10 20 30 40 50 60</small>
9	16	M6x25	 <small>mm 10 20 30 40 50 60</small>
10	8 Sets	138mm Handle (x8) + M4x10 screws (x16)	 <small>138 mm</small>

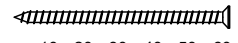
ANTI TIP-OVER HARDWARE

PART	QTY	SIZE / DESCRIPTION	ITEM
13	2	200x25mm Safety strip	 <small>200 mm</small>
14	2	M4x30mm Wall Anchor	 <small>mm 10 20 30 40 50 60</small>
15	2	M4x60mm	 <small>mm 10 20 30 40 50 60</small>

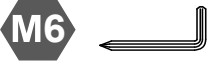
TOOLS INCLUDED

Combination Allen Key (Hex + Phillips)	
M10/M12 Hex wrench (Spanner)	

TOOLS REQUIRED BUT NOT INCLUDED

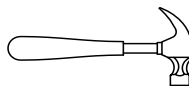
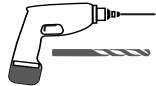
Pencil 	Hammer 	Power drill with M4 drill bits 
--	---	---

ASSEMBLY STEPS

WE RECOMMEND TO PLACE THE PIECES OVER BLANKETS OR TABLECLOTHS TO PROTECT THEIR FINISH DURING ASSEMBLY.

STEP 1

Hardware

1		2
	M7x40mm	Pcs

Tools (included)

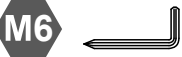

Assemble F to the bottom of C with #1.

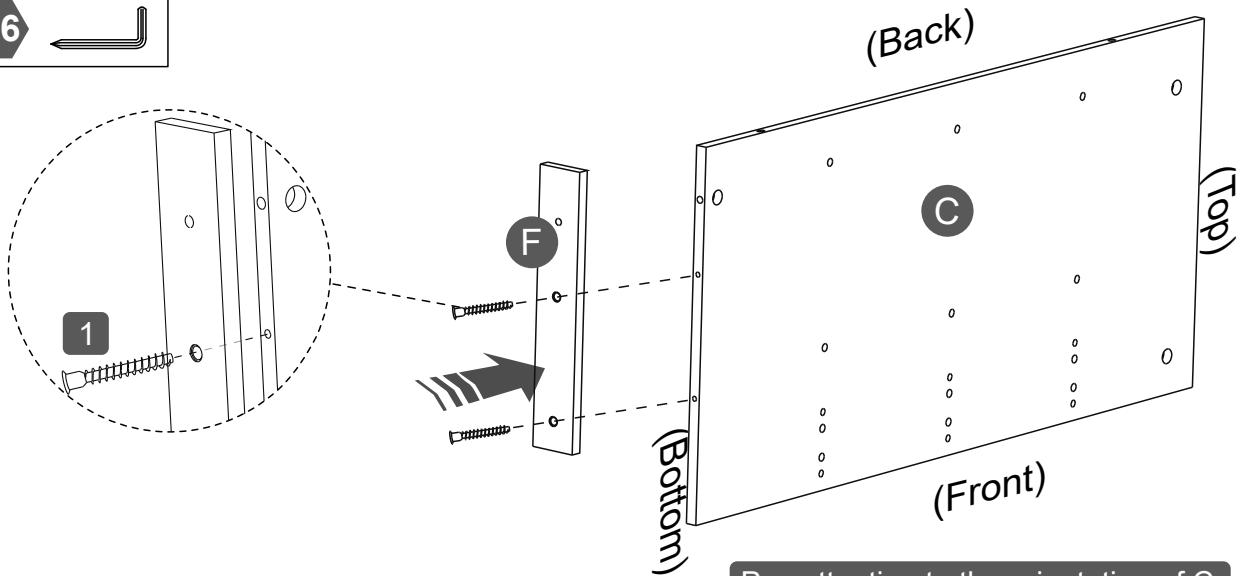

Pay attention to the orientation of C.

STEP 2

Hardware

1		2
	M7x40mm	Pcs

Tools (included)



Assemble J to G and K with #1.

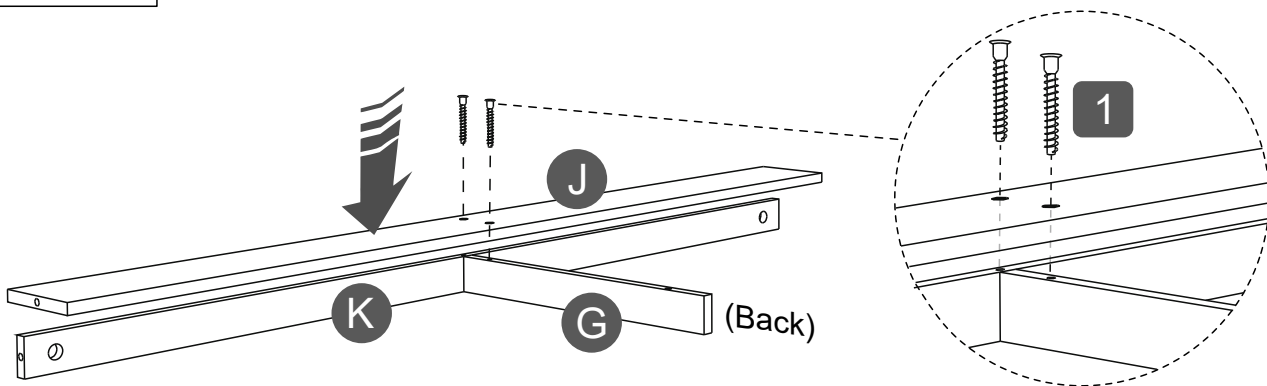

ASSEMBLY STEPS

STEP 3

Hardware

2		1 Pc
	M6x40	

3		1 Pc
	Ø15x10mm	

Tools (included)

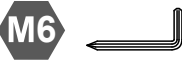

FIRST: Attach one bolt #2 to G.

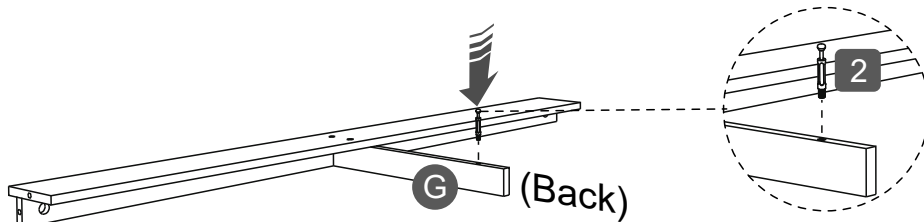

THEN: Join G to F, insert #3 into C, and turn it to lock the pieces.

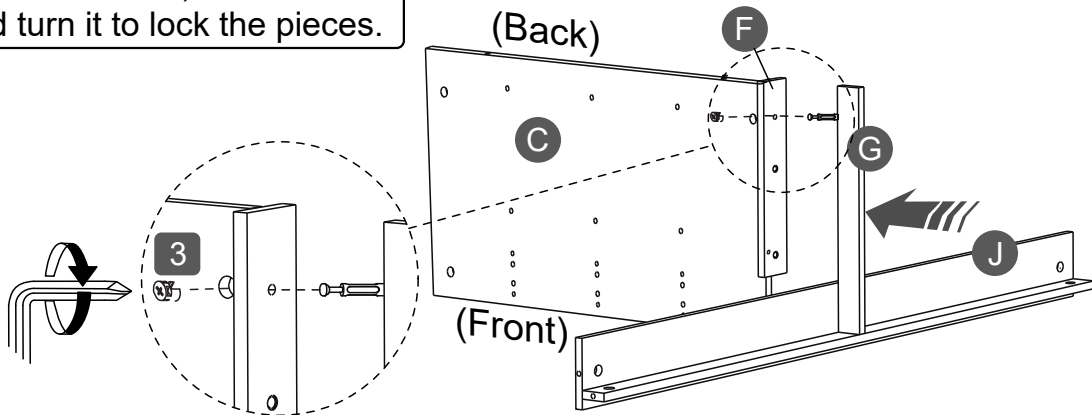

STEP 4

This step requires of  2 people

Hardware

4		6 Pcs
	M6x63	

5		6 Pcs
	Nut cap	

Tools (included)

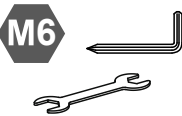



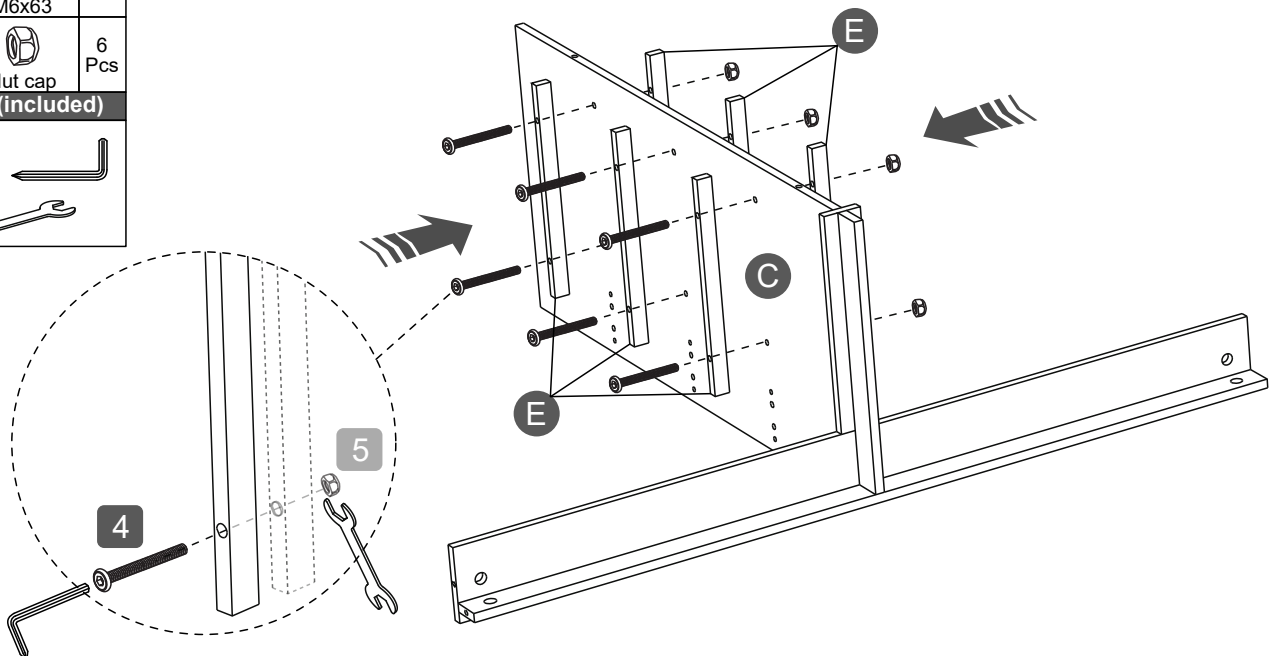

Assemble E to each side of C with #4 and #5. The screws #5 go from one side to the other through E, C, E, and cathes into nut #5.



ASSEMBLY STEPS

STEP 5

Hardware

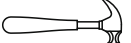
3		12 Pcs
	Ø15x10mm	
6		6 Pcs
	M6x48mm	
7		6 Pcs
	Ø8x40mm	
Tools (included)		
		
Tools (Not included)		
		

FIRST: Insert the double bolts #6 into the indicated holes on only 3 of the 6 panels D and lock the bolts with #3.

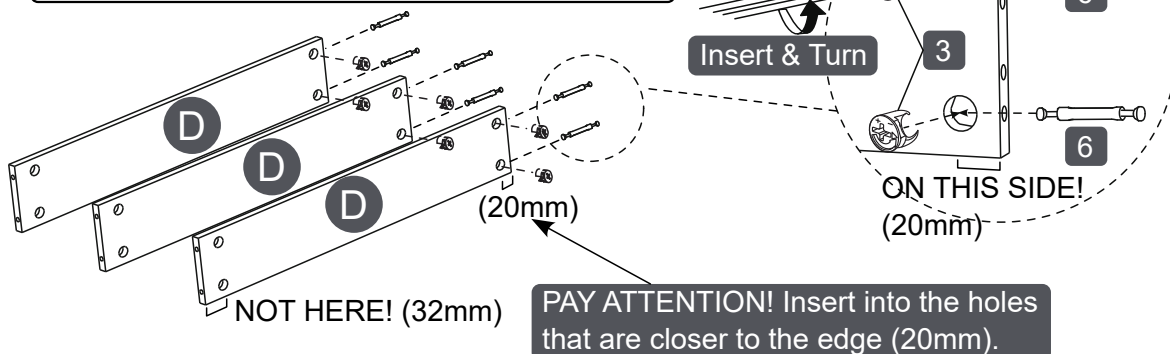

THEN: Insert the longer dowels #7 in the other holes on that same side.

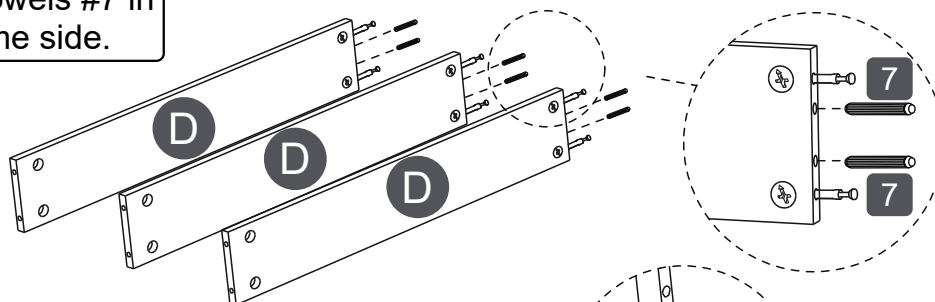

THEN: Connect those 3 panels D to C. The bolts and dowels will come out on the other side of C.

PAY ATTENTION! The surface with big holes facing towards the bottom.

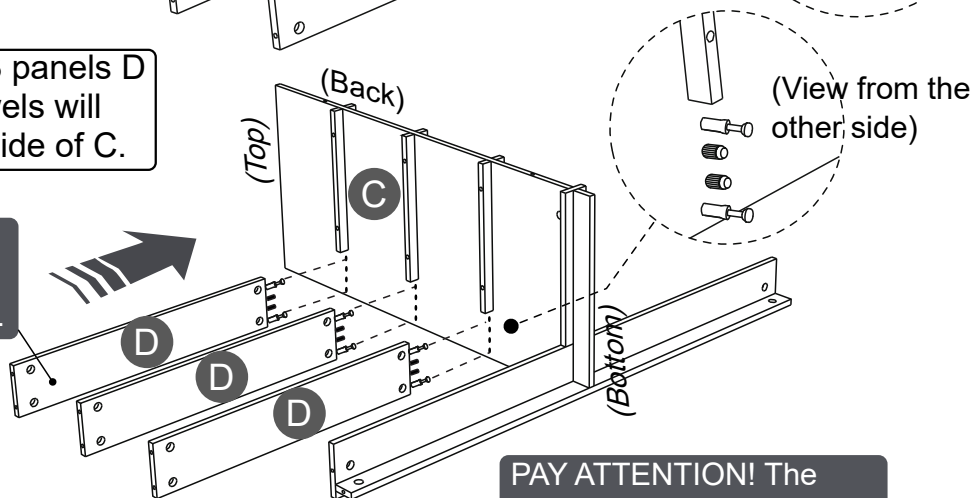

PAY ATTENTION! The surface with big holes facing towards the bottom.

LAST: On the other side of C, connect the other 3 panels D with #3 as shown.

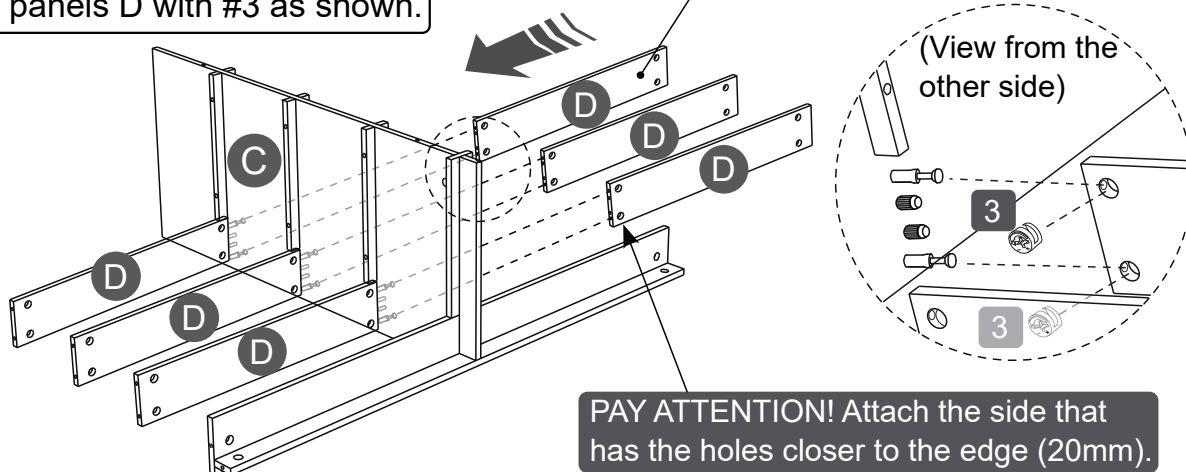

ASSEMBLY STEPS

STEP 6

Hardware

2		16 Pcs
	M6x40	

9		16 Pcs
	M6x25	

Tools (included)

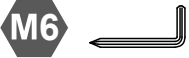

FIRST: Attach H to A with #9.

THEN: Attach I to B with #9.

⚠ PAY ATTENTION!
H goes on A;
I goes on B.

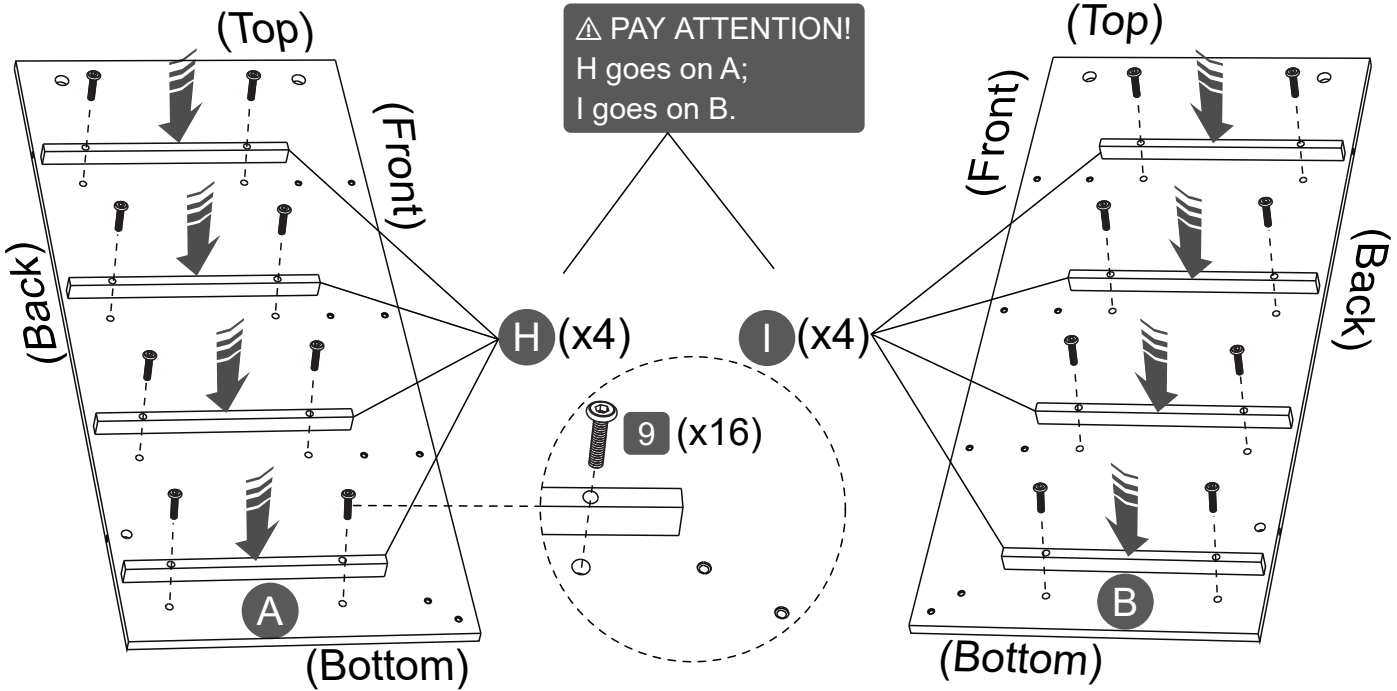

LAST: Attach #2 to both A and B.

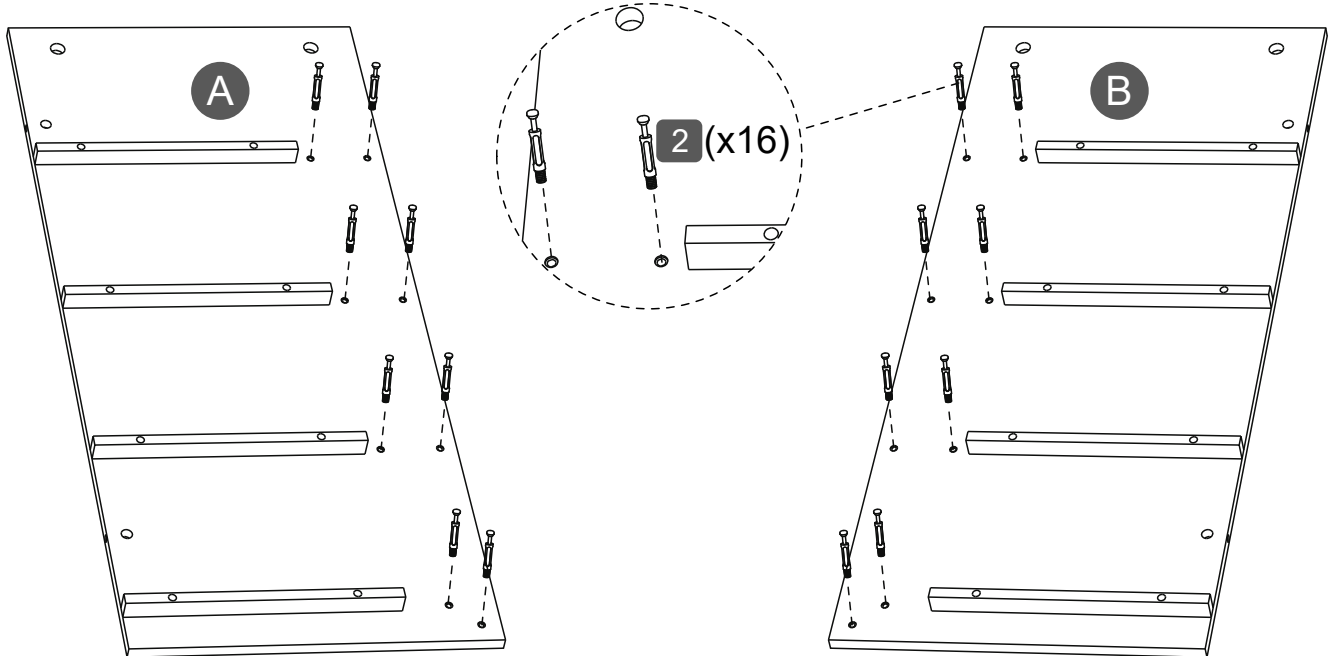

ASSEMBLY STEPS

STEP 7

This step requires of  2 people

Hardware

3  16 Pcs
Ø15x10mm

Tools (included)

 M6

FIRST: Use #3 to attach:
 • A to D, J and K on the RIGHT side;
 • B to D, J and K on the LEFT side.

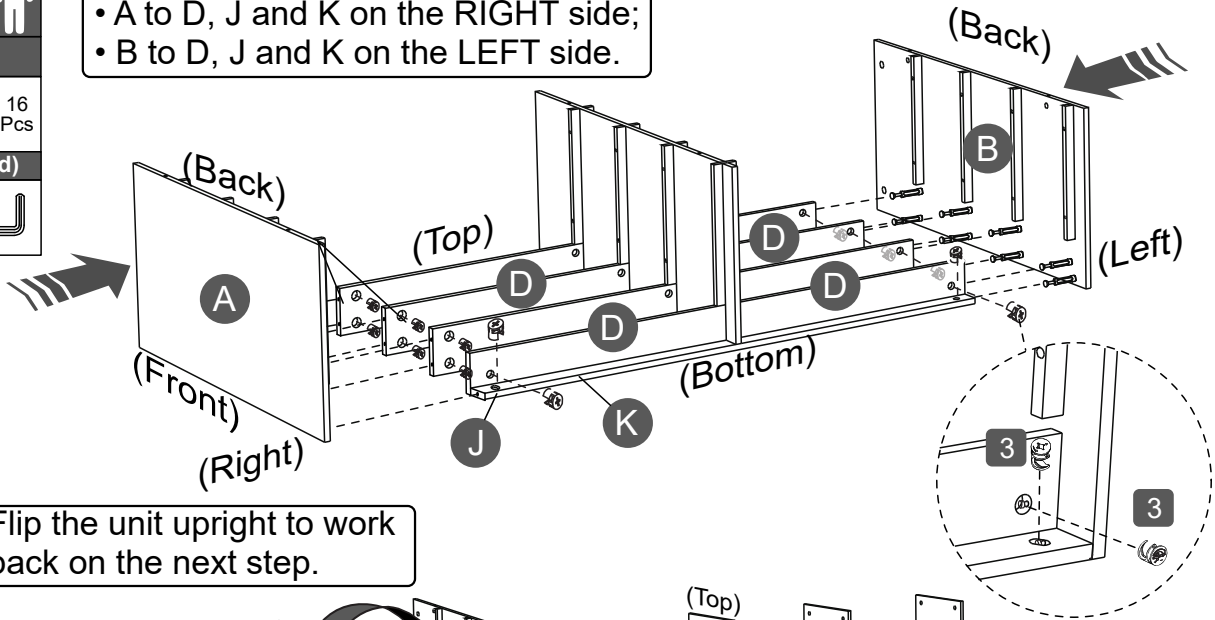

THEN: Flip the unit upright to work from its back on the next step.

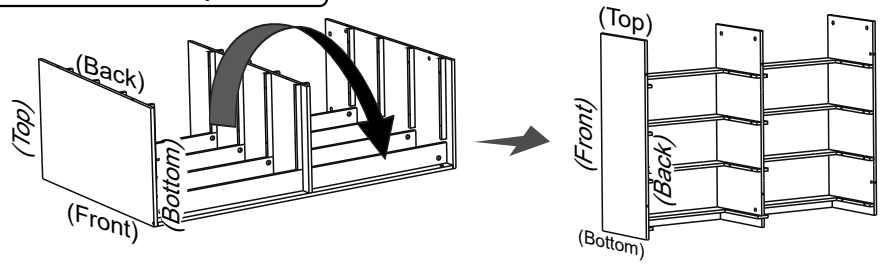

STEP 8

This step requires of  2 people

Hardware

2  6 Pcs
Ø6x40mm

3  6 Pcs
Ø15x10mm

Tools (included)

 M6

FIRST: Attach #2 to L.

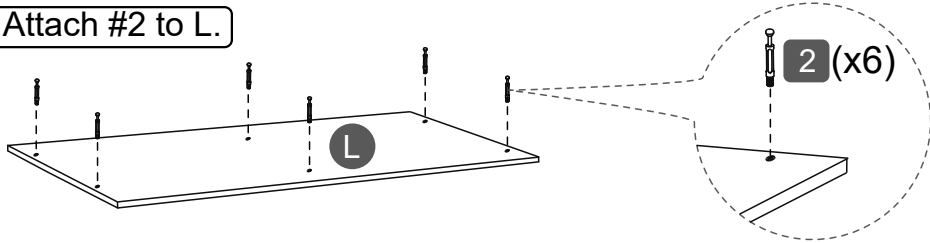

THEN: Attach L to A, B and C with #3.

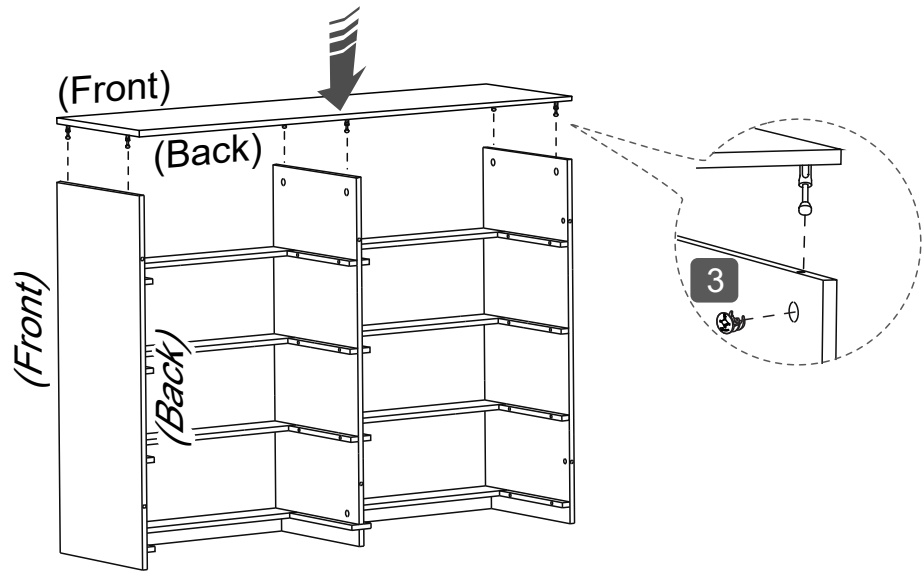

TIP OVER WARNING!

VERY IMPORTANT - PLEASE READ!

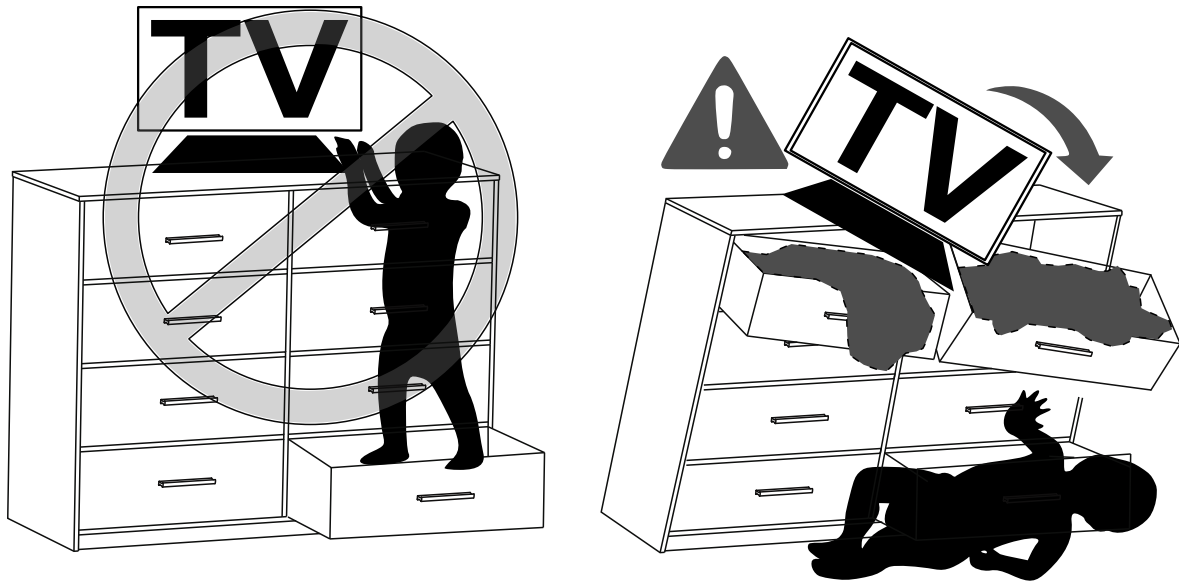

Children have died from furniture tip over. To reduce the risk of tip over:

- Install the anti tipping device that is included with this product.
- Follow the instructions on the next page of this manual for installing the anti tipping device and have the unit secure to a wall.
- NEVER allow children to stand, climb, or hang on drawers, doors or shelves.
- Place heaviest items in the lowest drawers.
- NEVER put a TV on this furniture.





Please continue with the rest of the assembly instructions on the next page. Thank you.

ASSEMBLY STEPS

STEP 9

This step requires of  2 people

Hardware

8		6 Pcs
13		2 Pcs
14		2 Pcs
15		2 Pcs

Tools (included)



Tools (Not included)

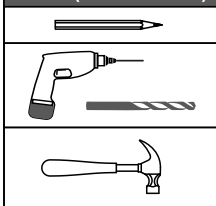

DO NOT SKIP THE INSTALLATION OF THE ANTI TIPPING DEVICE!

FIRST: On the back of the unit, attach the cross bars M to the panels A, B and C with screws #8, with the Safety Strips #13 also installed **AT THE TOP AND UNDER** the cross bars on A and B.

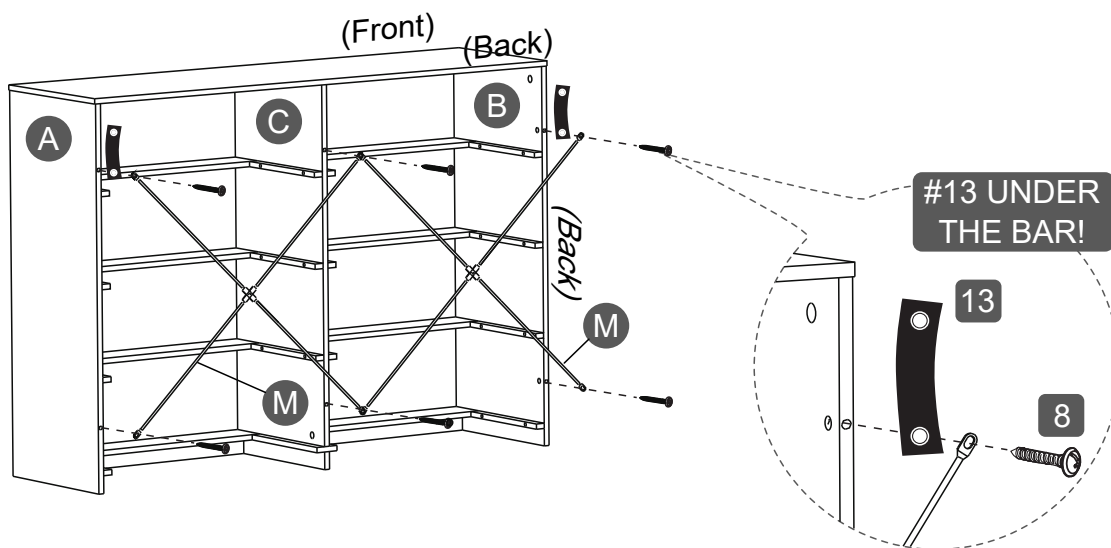

THEN: Put the unit against the wall where it will stay, and use a driller (not included) to make 2 holes on the wall and insert the anchor #14 for the 2 safety strips.

LAST: Secure the safety strips to the anchors with screws #15.

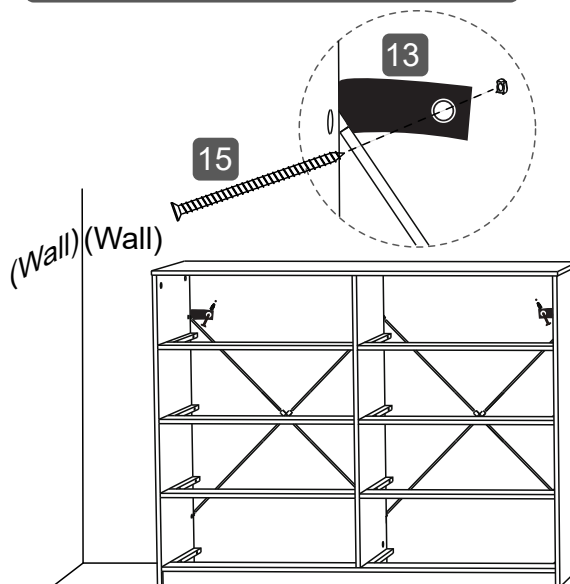
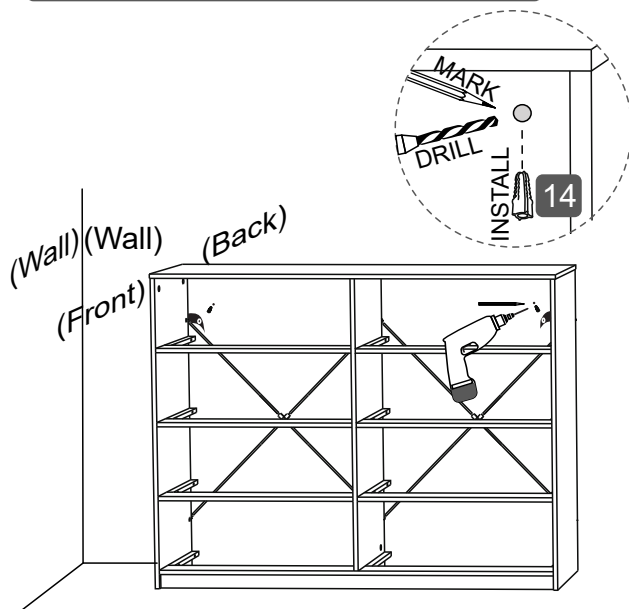

ASSEMBLY STEPS

STEP 10

Hardware

10		8 Sets
----	---	--------

Tools (Included)



FIRST: Unfold the drawers N and place the bottoms O into each of them.

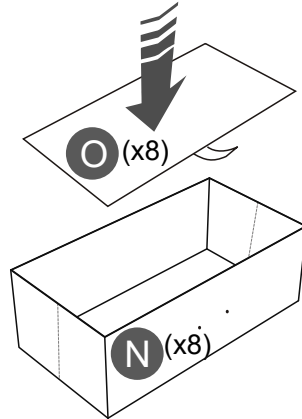
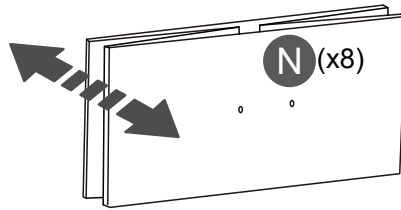

THEN: Attach the handles #10 to the drawers with their own screws.

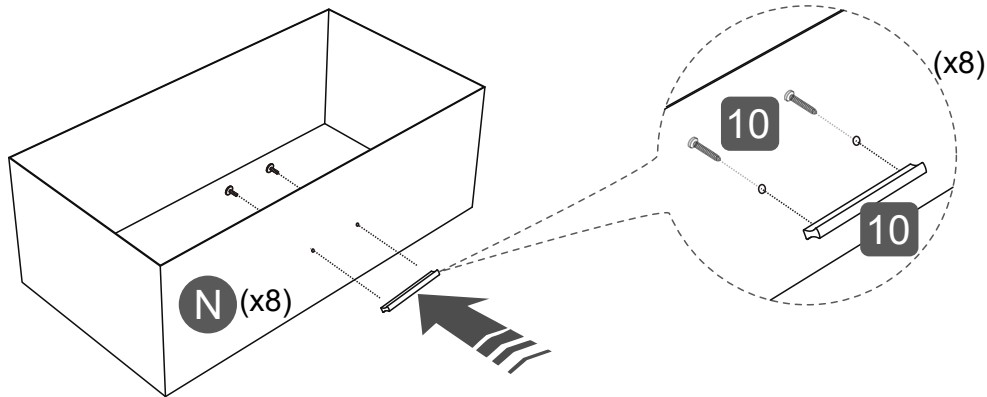

FINALLY: Insert the drawers into the unit.



WARNINGS

Not paying attention to the following warnings could result in injuries.

Children have died from furniture tip over. To reduce the risk of tip over:

- Make sure you have installed the anti tipping device that has been included with this product.
- NEVER allow children to stand, climb, or hang on drawers, doors or shelves.
- Place heaviest items in the lowest drawers.
- NEVER put a TV on this furniture.
- Every 4 months, inspect the anti tipping device to make sure it is still secured to both the unit and the wall.
- Do not exceed the indicated weight limits.

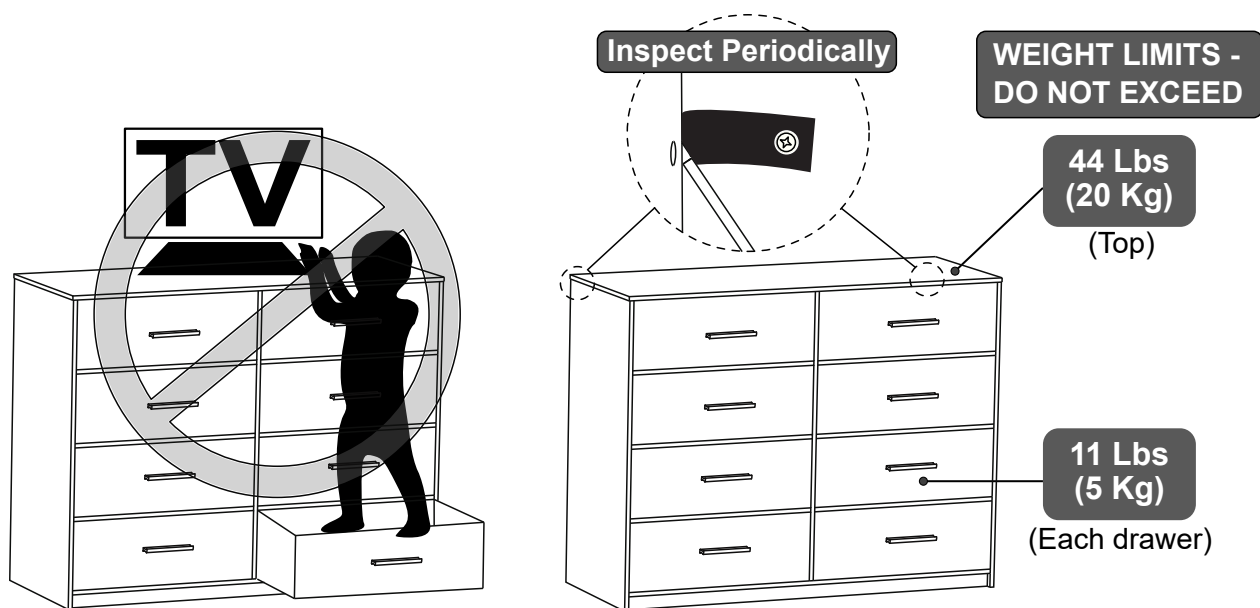

CARE AND MAINTENANCE

Clean with a cloth lightly dampened in a solution of mild soap and water.

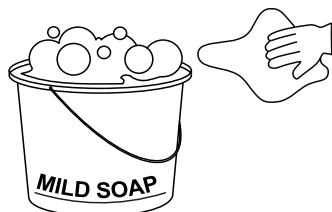

Do not use solvents or abrasive materials.



Do not expose to direct sunlight or extreme environmental conditions.

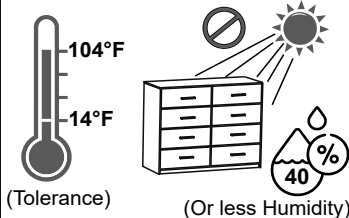

Inspect and re-tighten loose screws on the unit every 4 months.

