











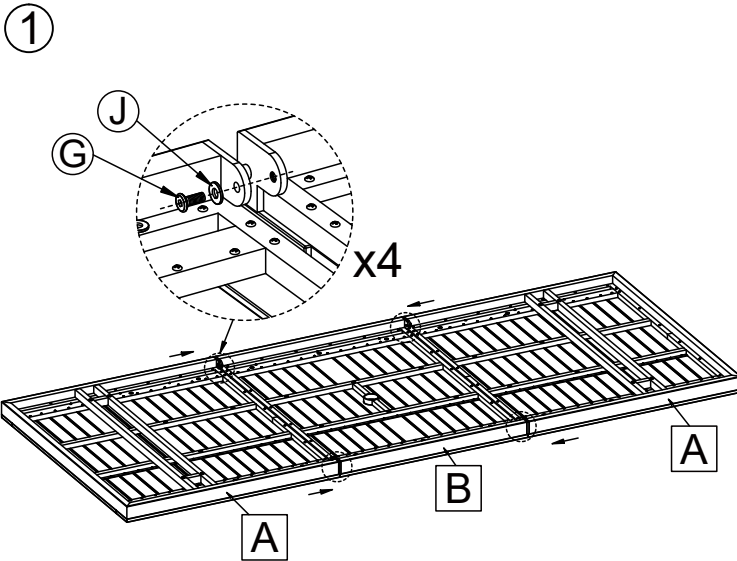
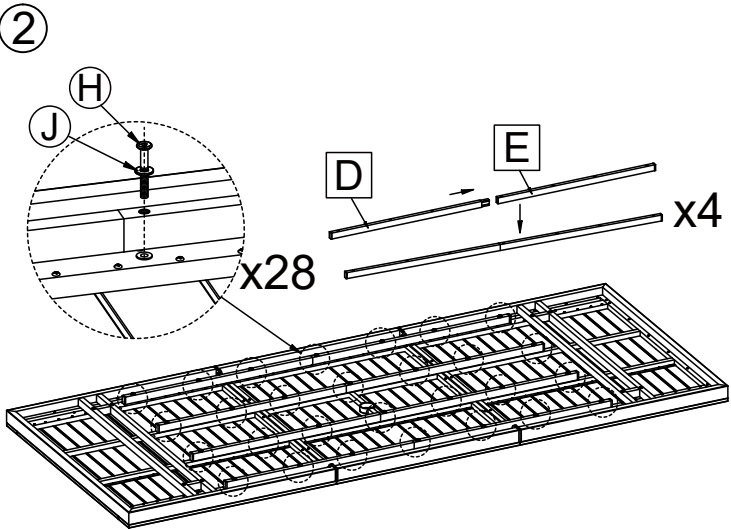

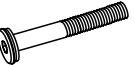
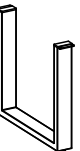
<p>A</p>  <p>2PCS</p>	<p>G</p>  <p>M6*15 4PCS</p>	<p>①</p>  <p>Do not tighten the screws completely in the step.</p>	<p>②</p>  <p>Do not tighten the screws completely in the step.</p>
<p>B</p>  <p>1PC</p>	<p>H</p>  <p>M6*45 28PCS</p>		
<p>C</p>  <p>2PCS</p>	<p>I</p>  <p>M8*25 8PCS</p>	<p>③</p>  <p>Do not tighten the screws completely in the step.</p>	<p>④</p>  <p>Tighten the screws into place with Allen Key (K) and Install the Caps (J) for protecting and concealing the screws.</p>
<p>D</p>  <p>4PCS</p>	<p>J</p>  <p>Ø15*Ø8.5*1.5 40PCS</p>		
<p>E</p>  <p>4PCS</p>	<p>K</p>  <p>M6 40PCS</p>		
<p>F</p>  <p>1PC</p>	<p>L</p>  <p>2PCS</p>		

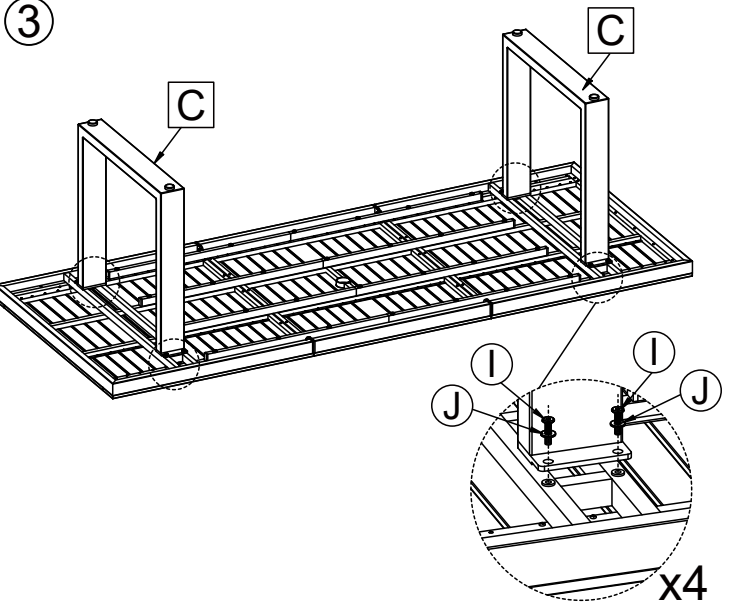
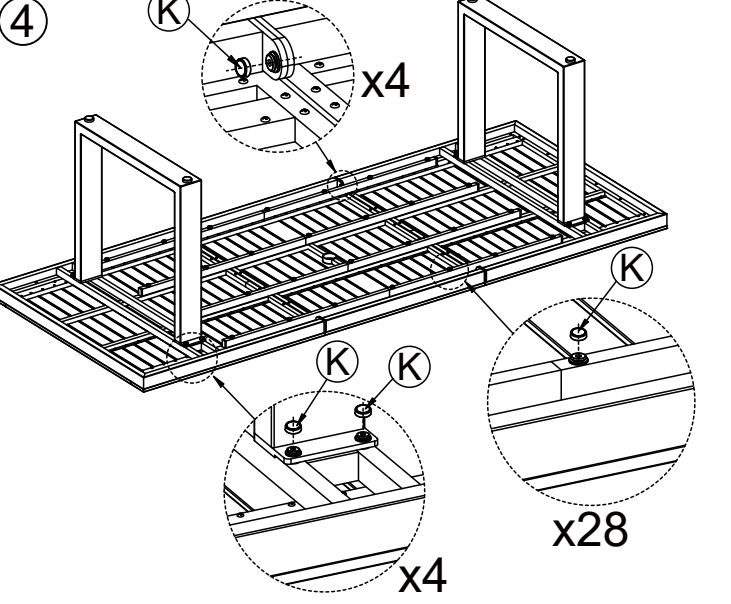

Tip: We recommend flattening the boxes to use as a protective work surface, or setting up your new furniture on a soft floor like a carpet.

5

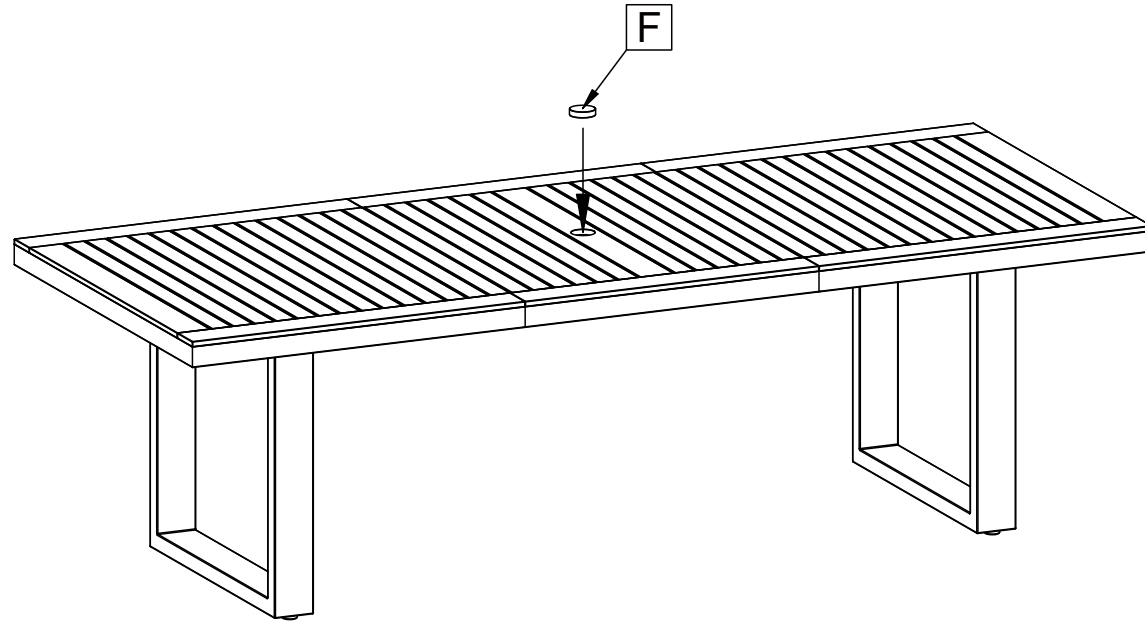

6

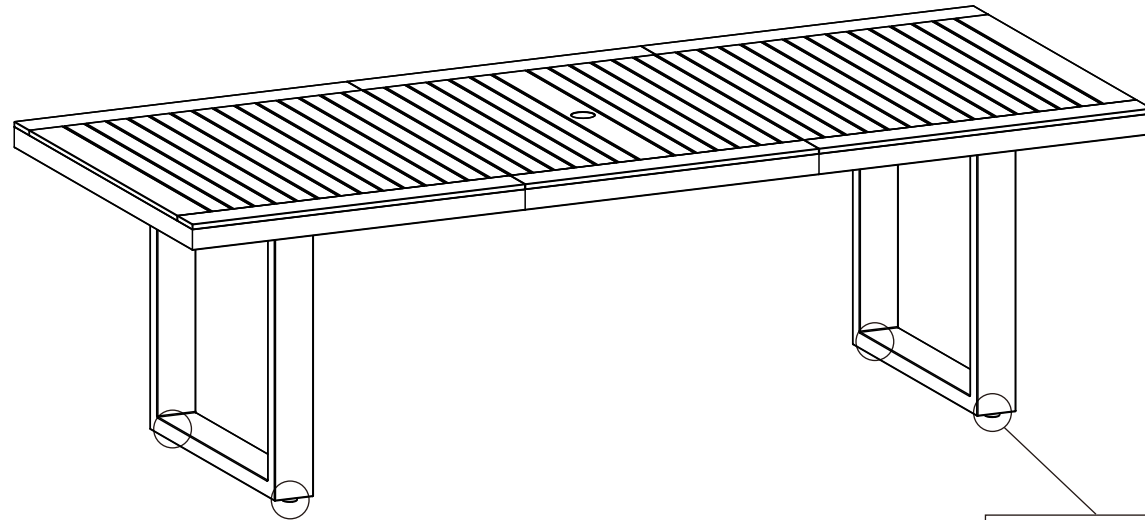

Adjust Pre-installed levers height for balance

