

ASSEMBLY INSTRUCTIONS
ITEM NO : WF309146
DESCRIPTION : KAYLEE DINING SET

Thank you for purchasing this quality product. Be sure to check all packing material carefully for small part that may have come loose inside carton during shipment.

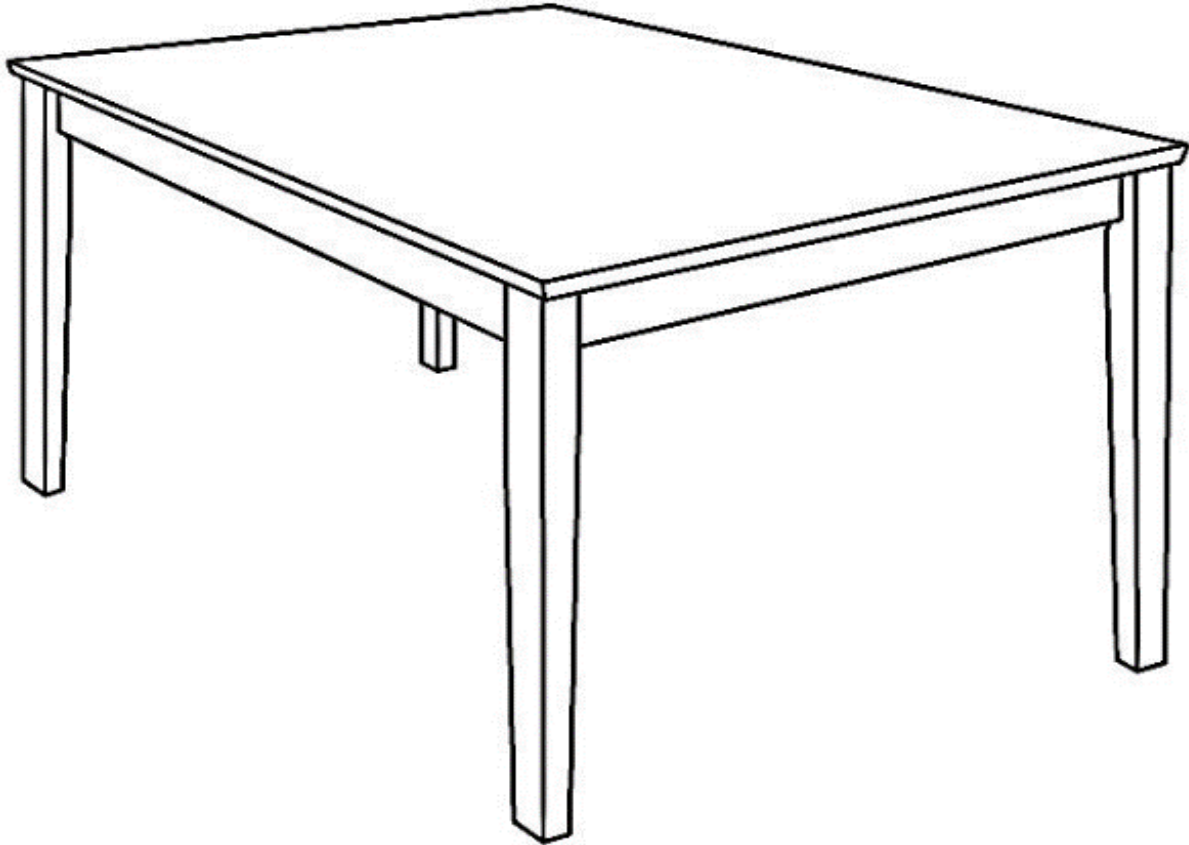

WF309146

ASSEMBLY INSTRUCTIONS

ITEM NO : WF309146





DESCRIPTION : KAYLEE DINING SET



Thank you for purchasing this quality product. Be sure to check all packing material carefully for small part that may have come loose inside carton during shipment.

PARTS LIST (FOR 1 TABALE)

NO.	COMPONENT	QTY.
A	TABLE TOP	1
B	TABLE LEG	4

HARDWARE LIST (FOR 1 TABLE)

NO.	DESCRIPTION	QTY.
1	M6 X 60 JCBC SCREW 	8
2	SPRING WASHER 	8
3	FLAT WASHER 	8
4	ALLEN KEY (SHARE WITH TABLE) 	1

1 x 8	 M6 x 60mm
2 x 8	
3 x 8	

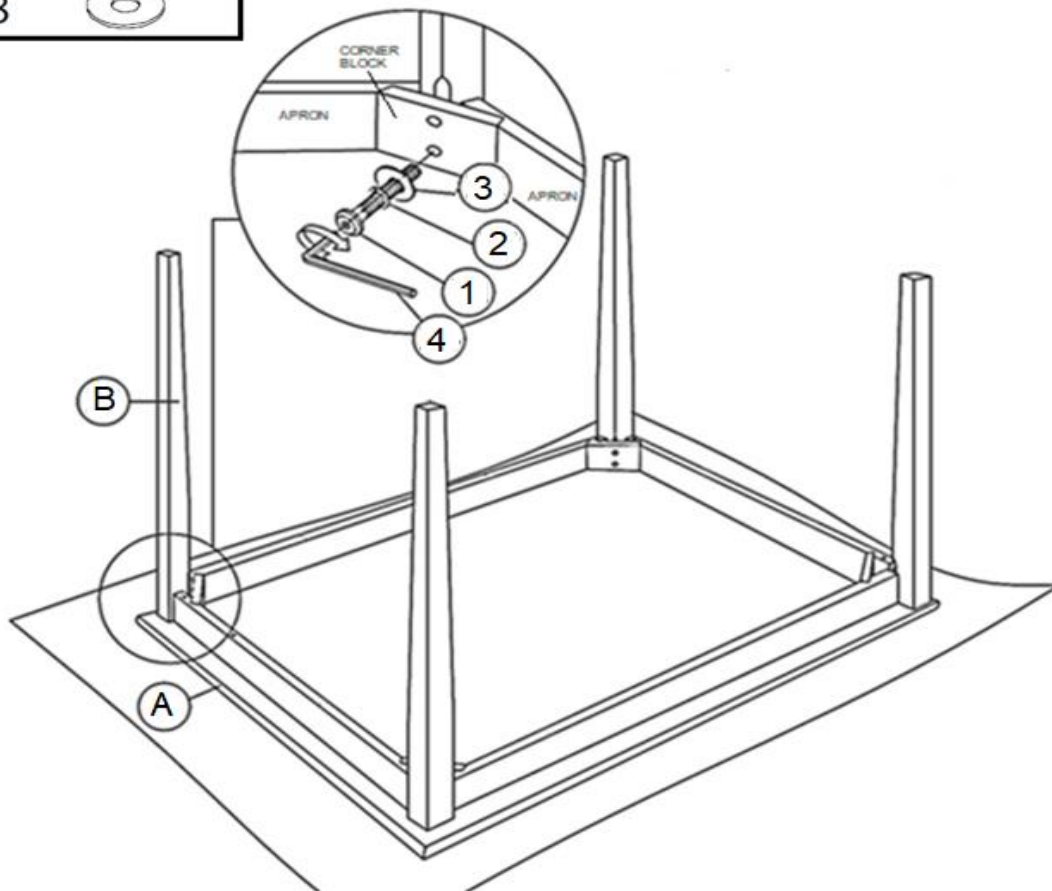

- With the assistance of another person, place Table Top (A) bottom-side up on a flat & soft surface to prevent scratch and damage.
- Position Table Leg (B) against each corner of the table aprons and align the screw holes on (B) to the screw holes on the corner block.
- Insert Screw (1) fitted with Spring Washer (2) and Flat Washer (3) through each hole on the corner block into screw hole on (B). Use Allen Key (4) to drive (1) to fasten (B) to the corner block.
Do not tighten (1) completely until both screws are in place . Do not over-tighten.
- Repeat the above assembly procedure for the other three legs
- With assistance, set the table right-side up when all 4 legs are installed.