



Contact Us: help-keking@outlook.com

Website: www.kkkening.com

Facebook: KE KING

INSTRUCTION

SMART TOILET

Concealed cistern series

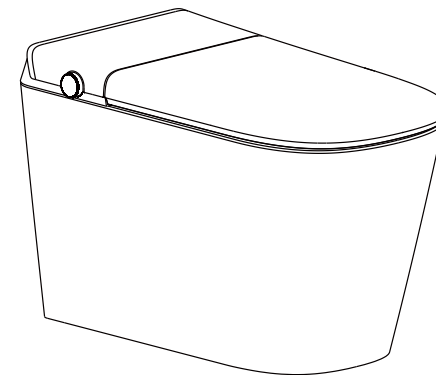

- Thank you for purchasing our product. Before using, please read the instruction carefully. Please keep the instruction properly for further reference.
- Our company reserves the right of final interpretation for this manual. The manual is subject to change without notice.

Catalogue

Packing List	02
Component	04
Technical Drawing	05
Features	05
Attentions	07
Installation Instruction	14
Preparation before Use	20
Panel Instruction	21
How to Use	24
Function Setting and Adjustment	25
Cleaning and Maintenance	30
Troubleshooting	34
Function List	35
Product Specification	36
Acceptance Record	37

Packing List

Dear user,
Please count the following items after opening the package:

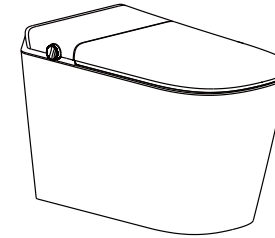

Smart Toilet

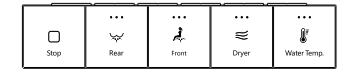

Remote Control

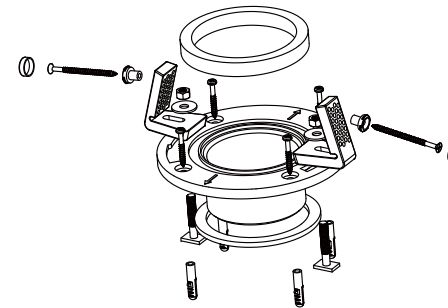

Flange, Sealing Wax Rings,
Mounting Accessory Kit

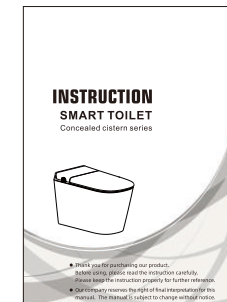

Instruction Manual

Packing List

Dear user,
Please count the following items after opening the package:

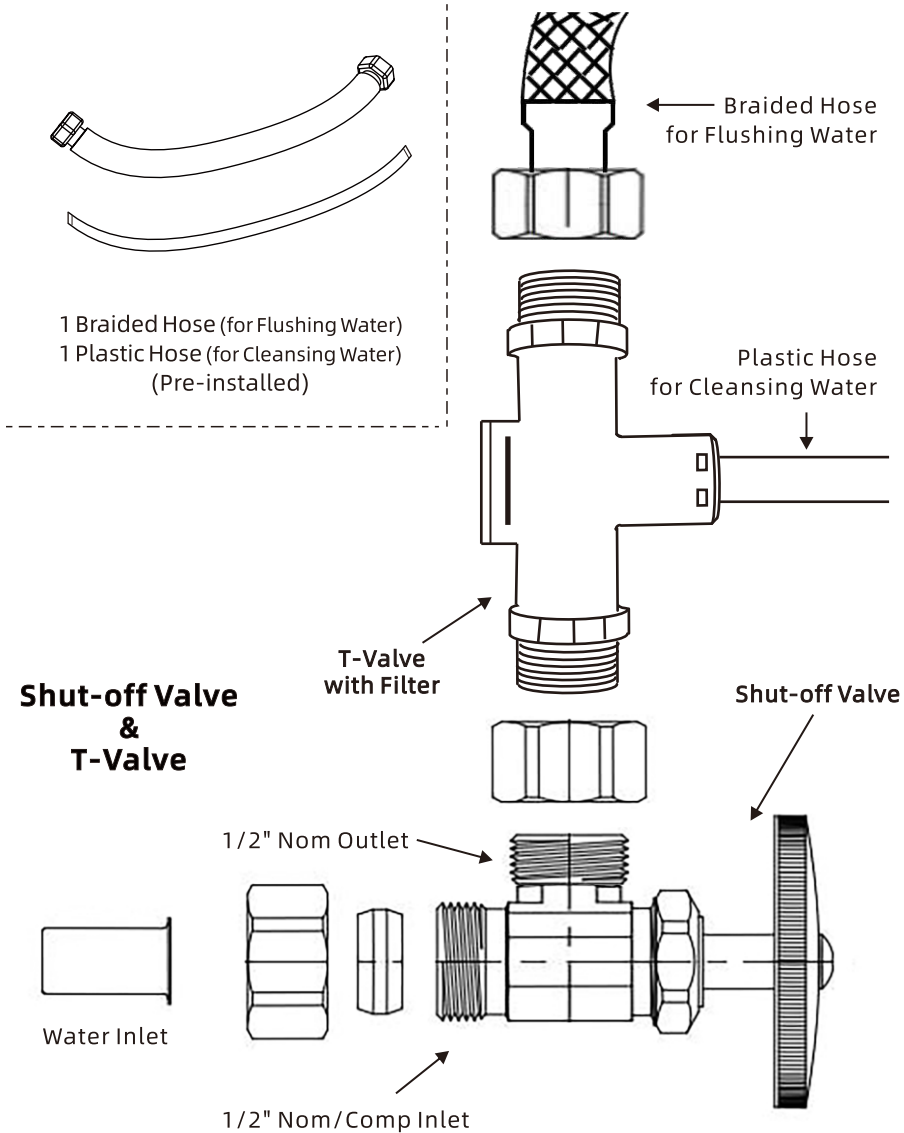

Component

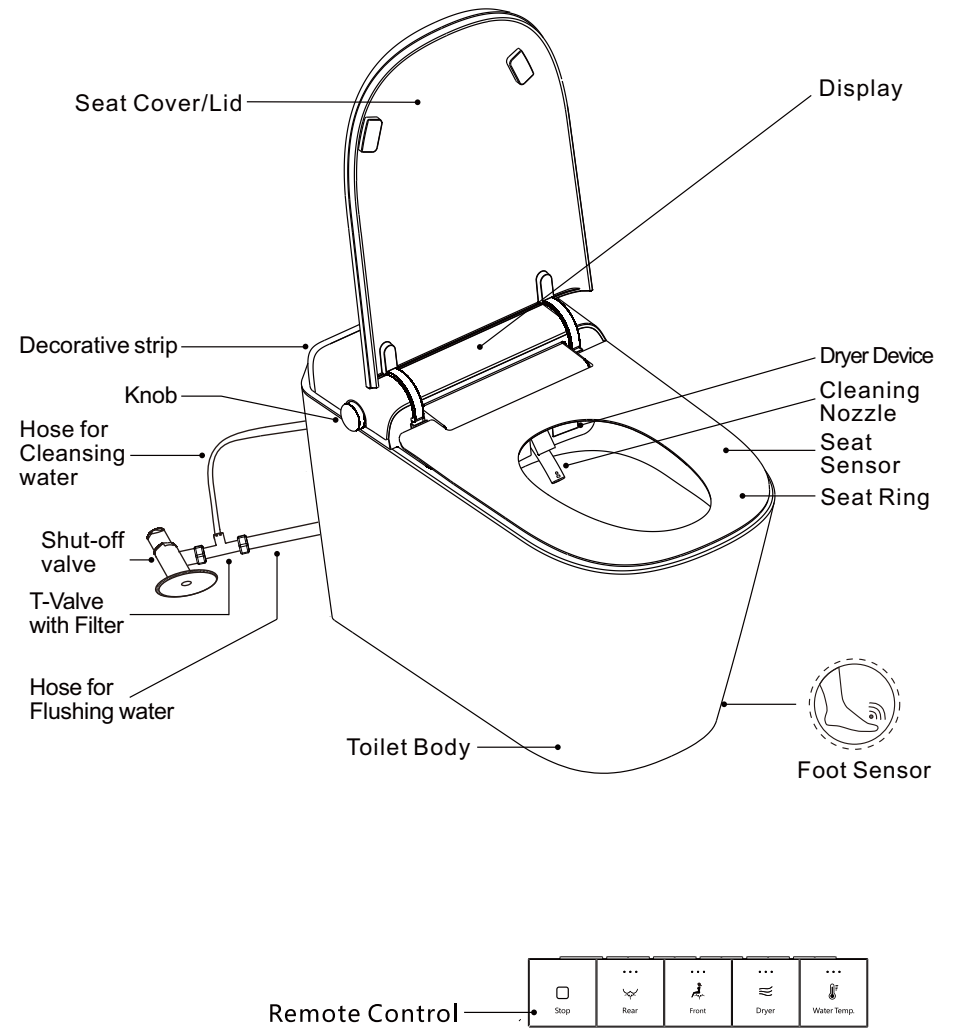

Technical Drawing

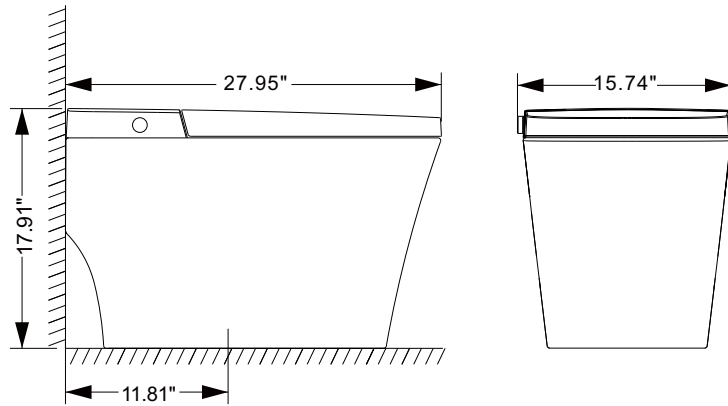

Features

Remark: The below features/functions can also be activated and adjusted by the wireless remote control, details will be listed in the later part of this manual.

Foot Sensor to Open / Close the Lid / the Seat Ring

Open / close the lid or the seat ring when user lifts their foot around the sensor.

Aperient

Water comes from the single-hole of the nozzle with strongest level of pressure to assist with bowel movements.

H/C Massage

The nozzle alternates hot and cold water to massage.

Rear Cleansing

Water comes from the single-hole of the nozzle, powerful cleansing.

Rear Cleansing with Nozzle Oscillation

The nozzle moves back and forth to wash with wide range.

Front Cleansing

Water comes from the nozzle hole designed for female use, gentle cleansing.

Front Cleansing with Nozzle Oscillation

The nozzle moves back and forth to wash with wide range.

Features

Cleansing Strength Adjustment

Adjust the cleansing strength/water pressure according to your preference.

Cleansing Position Adjustment

Adjust the cleansing position by moving the nozzle forward and backward.

Cleansing Water Temperature Adjustment

4 levels of cleansing water temperature adjustment: normal (room temperature) / high / medium / low.

Warm Air Dryer

Warm air dryer with 4-level temperature control (room temperature / high / medium / low), drying after cleansing.

Seat Sensor

All corresponding functions will be activated and be ready after seated.

Seat Ring Temperature Adjustment

Heated seat with 4 levels of temperature adjustment: normal (room temperature) / high / medium / low.

Remote Control

All functions can be accessible by the wireless remote control.

Off Seat Auto Flush

Auto flush after using and standing up from the bidet toilet seat.

Foot Sensor Flush

Flush by lifting the foot near the sensor.

Flush by Remote Control

Flush by pressing the flush button on the remote control.

Flush by Side Knob

Flush by pressing the side knob on the smart toilet.

Night Light

The night light is designed to be gentle on the eyes and provide enough illumination to navigate the bathroom without needing to turn on any harsh overhead lights.

Nozzle Cleaning

Long press the corresponding button on the remote control when unseated, the nozzle will enter the self cleaning mode. Easy for daily maintenance.

Nozzle Auto Cleaning

Nozzle will auto clean itself before and after using.

Attentions



NO WATER

Do not pull the plug with wet hand.

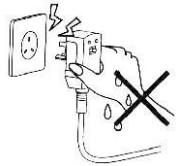

▲Otherwise, it may cause electric shock.



PROHIBIT

Do not pour water, detergent or deodorant on the smart toilet main unit and power plug. Otherwise:

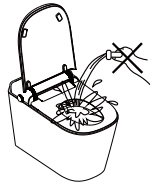

▲It may cause fire, electric shock, short circuit or damage.

▲Injury or indoor water seepage may occur due to product damage.



PROHIBIT

When there is thunder, do not touch the power plug.

▲Otherwise, it may cause electric shock.



PROHIBIT

Do not touch the water inlet hose to the power plug or outlet.

▲Otherwise, it may cause fire, electric shock, heating, or short circuit due to condensation.



PROHIBIT

Do not damage the power cord or plug. Do not forcefully drop, pull, twist, bend, scratch, process, heat, place heavy objects on, tie, or clamp the power cord or plug.

▲Otherwise, it may cause product damage. Continuing to use the product in a damaged state may cause fire, electric shock, heating, or short circuit.



PROHIBIT

Do not use power outlets that are loose or malfunctioning.

▲Otherwise, it may cause fire or short circuit.



PROHIBIT

Please use power outlets and wiring tools within the specified range.

▲When the wiring exceeds the specified range of the outlet, it may cause fire due to overheating.



PROHIBIT

Do not use a power source other than the specified one (AC 110V, 60Hz). Please do not plug in until the inlet valve opens.

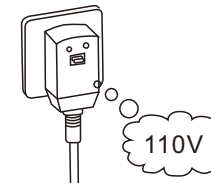

▲Otherwise, it may cause fire.



NO DISASSEMBLE

Do not disassemble, repair, or modify this product on your own.

▲Otherwise, it may cause fire, electric shock, heating, short circuit or damage.



PROHIBIT

Do not install on a moving vehicle, ship, or other mobile structure. Otherwise:

▲It may cause fire, electric shock, short circuit, or malfunction.

▲The seat ring, seat cover, and smart toilet main unit may be damaged due to detachment and falling.



PROHIBIT

When the smart toilet malfunctions, do not continue to use it. In the following situations, turn off the power and close the water inlet valve to stop the water supply.

*Water leaks from the hose or product inside to the outside.

*The product has cracks or damage.

*Abnormal sound or odor.

*Product smoking.

*Product abnormal heating.

*The cushion of the seat ring falls off.

▲Continuing to use the product in a malfunctioning state may cause fire, electric shock, heating, short circuit, injury, or indoor water seepage.



Do not use water sources other than tap water or potable well water (groundwater). Otherwise:

PROHIBIT

- ▲It may cause corrosion in components or machine malfunctions.
- ▲It may cause skin inflammation or burns due to unclean water.



Do not put your fingers or other objects into or block the warm air outlet, and do not place or cover objects or clothing on the warm air outlet.

PROHIBIT

- ▲Otherwise, it may cause burn, electric shock, or burning of accessories.



Beware of low-temperature burns.

MANDATORY

- ▲Improper use of the warm seat ring may result in low-temperature burns.
- ▲If sitting on the seat ring for a long time, please set the temperature of the seat ring to normal/unheated (room temperature).
- ▲When using the warm seat ring or warm air drying function, please set the temperature of the seat ring to normal/unheated (room temperature) and the temperature of the warm air dryer to the lowest setting for the following groups of people.

* Children, the elderly, and those who are unable to adjust the temperature to a suitable level themselves.

* Individuals with behavioral impairments such as patients or people with disabilities.

* Individuals who have taken hypnotic drugs (such as sleeping pills, cold medicine, etc.), heavy drinkers, and those who are excessively fatigued must use this product under the supervision of a responsible person.



Please confirm that the power outlet has been waterproofed.

MANDATORY

- ▲Make sure of the position of the outlet before installation and keep it away from the bathtub as much as possible.
- ▲If it is not waterproofed, it may cause fire or electric shock.
- ▲For the installation and waterproofing of the outlet, please consult qualified professionals.



Please confirm that the outlet being used is correctly grounded.

MANDATORY

- ▲Otherwise, it may cause electric shock due to malfunction or short circuit.
- ▲When installing the ground wire, please entrust a professional installation company.



Do not pull out the power plug by holding the power cord. When unplugging the power plug, do not hold the power cord, but hold the power plug.

MANDATORY

- ▲Otherwise, it may cause fire or heating due to damage to the power cord.



Please make sure to firmly insert the power plug into the outlet.

MANDATORY

- ▲Otherwise, it may cause fire, heating, or short circuit.



If the power cord is damaged, it must be replaced by the manufacturer, maintenance department, or other professionals to avoid potential hazards.

MANDATORY



When performing maintenance (not include the nozzle cleaning function), be sure to turn off the power.

MANDATORY

- ▲Otherwise, it may cause electric shock.



This is an electrical product. Do not install it in places where it is easy to be splashed with water or where the humidity is high. When using it in the bathroom, please install an exhaust fan or ventilation opening to keep the bathroom well ventilated.

MANDATORY

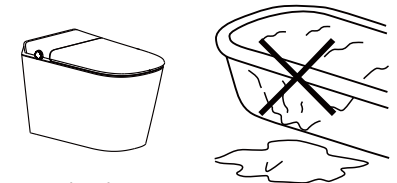

- ▲Otherwise, it may cause fire or electric shock.



When removing the smart toilet main unit, be sure to disconnect the power.

MANDATORY

- ▲Otherwise, it may cause fire or electric shock.



Individuals with physical, sensory, or cognitive disabilities, or those lacking experience and knowledge of this product (including children), must use this product under the supervision of a responsible person. Children should not play with this product.

MANDATORY

- ▲Otherwise, it may cause burn, electric shock, fire, or injury.



Do not let cigarettes or other sources of fire get close to the product.

▲Otherwise, it may cause fire.

NO BURNING



When maintaining plastic parts (seat ring, seat cover, etc.) and water inlet hoses, please use kitchen detergent (neutral). Do not use the following items: toilet cleaner, household detergent, gasoline, benzene, washing powder, or nylon brushes. Otherwise:

▲It may damage plastic parts, causing cracks and resulting in personal injury or malfunction.

▲It may damage the water inlet hose and cause water leakage.

PROHIBIT



Do not forcibly impact the product. Do not place heavy objects on or stand on the seat ring, seat cover, or smart toilet main unit. Otherwise:

▲The product may crack, and the smart toilet main unit may detach and fall, causing personal injury.

▲Injury or indoor water seepage may occur due to product damage.

PROHIBIT



Do not use the smart toilet when its main unit is loose.

▲Otherwise, the smart toilet main unit may detach and fall, causing personal injury.

PROHIBIT



Do not use your hands to lift the smart toilet main unit by holding the seat ring or seat cover. Do not open the seat ring or seat cover when there are items on them.

▲Otherwise, the smart toilet main unit may detach and fall, causing personal injury.

PROHIBIT



Do not violently open or close the seat cover or seat ring, or swing the seat cover and seat ring quickly. Otherwise:

▲The flipping device may fail due to the powerful external force.

▲The main unit may break or detach from the toilet body due to powerful external force, causing personal injury.

PROHIBIT



Do not bend or damage the water inlet hose.

▲Otherwise, it may cause water leakage.

PROHIBIT



To prevent sudden water leakage, do not remove the filter in the t-valve when the shut-off valve is open.

▲Otherwise, water may spray out.

▲Please refer to the cleaning method for the water inlet filter described on page 33.

PROHIBIT



Please use the new hose component provided with the product. The old hose cannot be reused.

▲Using the old hose component may result in water leakage or hose rupture.

PROHIBIT



When water leaks, be sure to turn off the shut-off valve.

MANDATORY



In order to prevent pipes or hoses from being damaged due to freezing, anti-freezing measures should be taken.

▲When the water inlet hose is frozen, it may damage the main unit of the smart toilet or the pipe and cause water leakage.

▲If the room temperature is below 32°F/0°C, it is recommended to empty the water inside the product to prevent internal cracking due to freezing.

MANDATORY



When the smart toilet is not used for a long time, be sure to drain the water from the smart toilet main unit and water inlet hose, and disconnect the power supply. When using it again, please first let the water flow through, and then use it. Otherwise:

▲It may cause skin inflammation due to water deterioration.

▲If the power is always turned on, it may cause fire or heating.

MANDATORY



When installing the water inlet filter, make sure to tighten it firmly to the correct position.

▲Otherwise, it may cause water leakage.

MANDATORY



Do not use any paper other than toilet paper, and do not drop objects that may clog the drain into the toilet bowl.

▲Otherwise, it may cause blockages in the ceramic pipes of the toilet.

MANDATORY



Do not operate the remote control with wet hands, and do not spill water on the remote control.

PROHIBIT

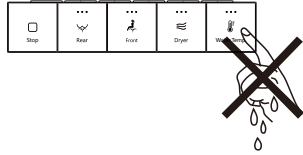

▲Otherwise, it may cause remote control malfunctions.



Do not put any solid substances or corrosive liquids into the water tank.

PROHIBIT

▲Otherwise, it may cause blockages or corrosion of the flushing water pipe.

Installation Instruction

■ Installation of the Smart Toilet

1. Confirmation of installation environment

Before installation, please confirm that the bathroom wall and floor tiles have been completed, and that the sewage pipes, water pipes, and electrical circuits have been reserved as shown in the figure below. This toilet rough-in is 300mm (11.81in); Water inlet pressure range: 0.15Mpa (dynamic) - 0.75Mpa (static); water inlet temperature: 4°C-35°C (39.2°F-95°F).

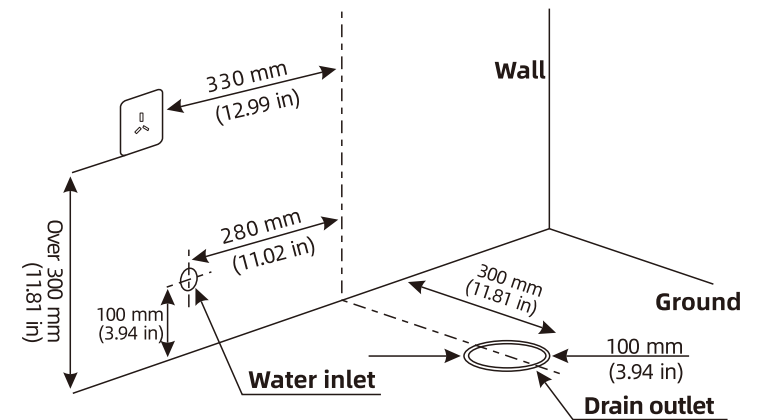

2. Assembly of dedicated shut-off valve

Install the shut-off valve provided with the product.

- Note: Remove the old water supply valve if it has been installed before.

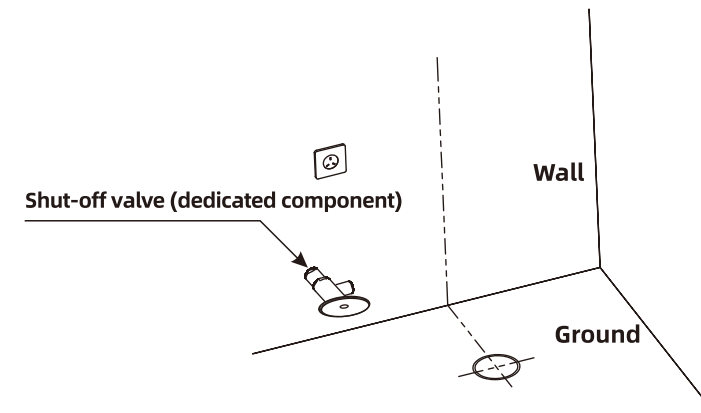

3. Installation and mounting of the toilet

(1.1) Assemble the mounting bracket with bolts and then secure them to the flange on the ground and tighten with nuts. **Please refer to Figure 1.0 on the next page for details.**

(1.2) Install the toilet on the corresponding position.

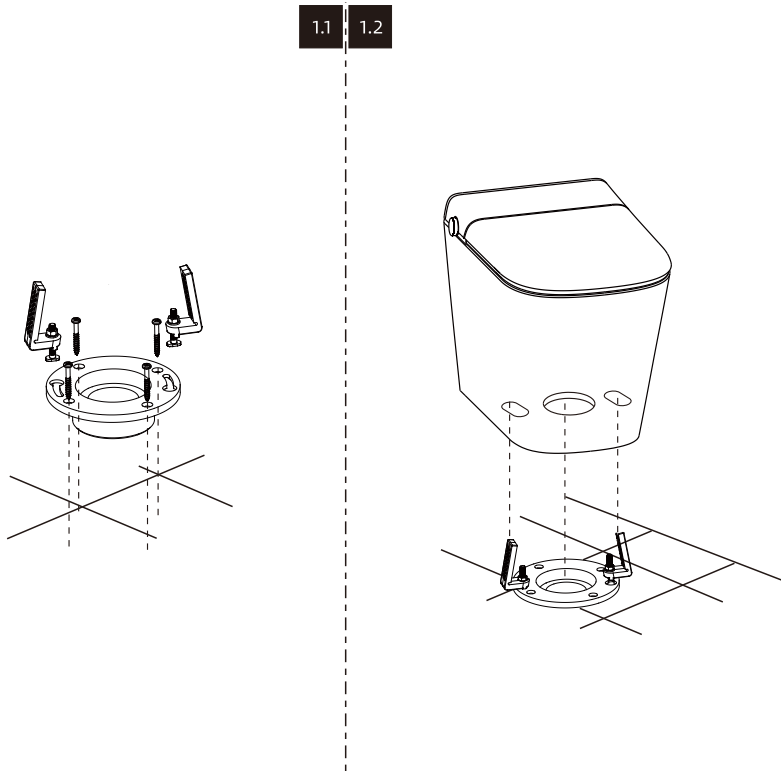

1.0

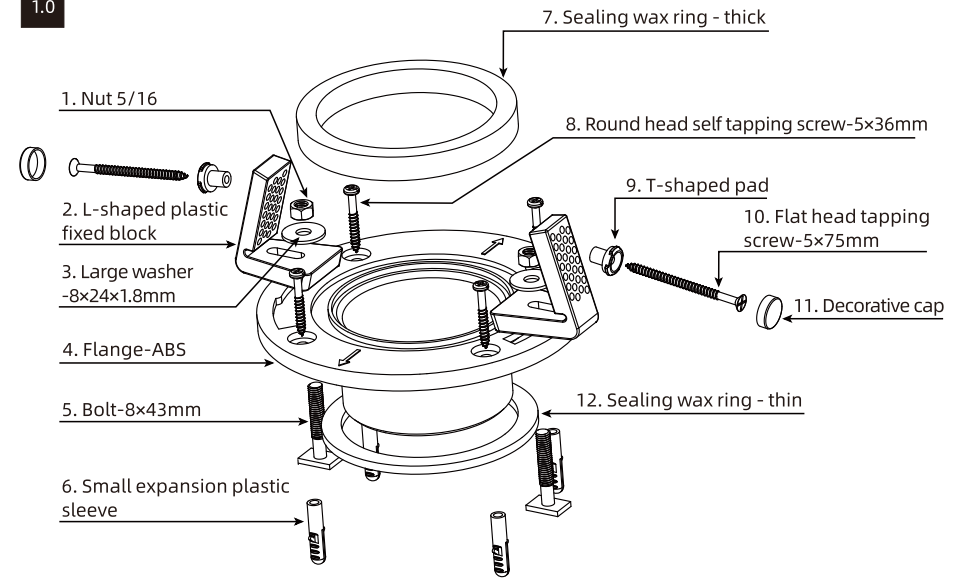

Flange accessories package

Details:

1. Nut 5/16 (2pcs)
2. L-shaped plastic fixed block (2pcs)
3. Large washer-8x24x1.8mm (2pcs)
4. Flange-ABS (1pc)
5. Bolt-8x43mm (2pcs)
6. Small expansion plastic sleeve (4pcs)
7. Sealing wax ring - thick (1pc)
8. Round head self tapping screw-5x36mm (4pcs)
9. T-shaped pad (2pcs)
10. Flat head tapping screw-5x75mm (2pcs)
11. Decorative cap (2pcs)
12. Sealing wax ring - thin (1pc)

Optional accessories

13. Outer hexagon self tapping screw-6x60mm (2pcs)
14. Small washer-6x16x1mm (2pcs)
15. Large expansion plastic sleeve (2 pcs)

Optional accessories

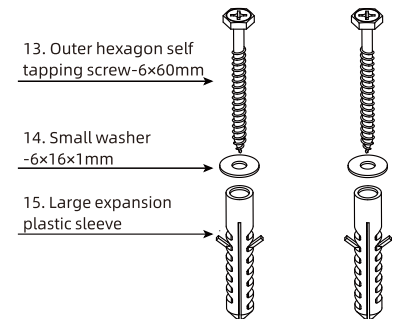

(2.1) Put the screw through the T-shaped pad and then install it through the holes (on both sides of the toilet ceramic) to the mounting bracket (L-shaped plastic fixed block) on the ground, and tighten it securely with a tool.

(2.2) Put the decorative cap on the T-shaped pad.

(2.3) Connect the water inlet hose and water pump with the water tank and tighten them with an adjustable wrench.

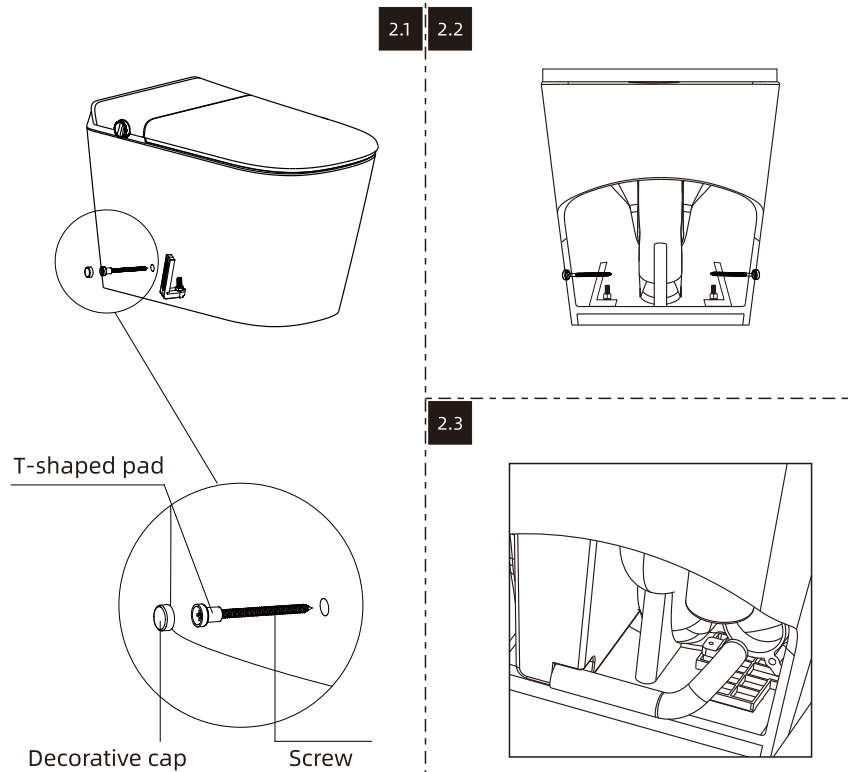

(3) Caulk the bottom of the toilet with silicone sealant.

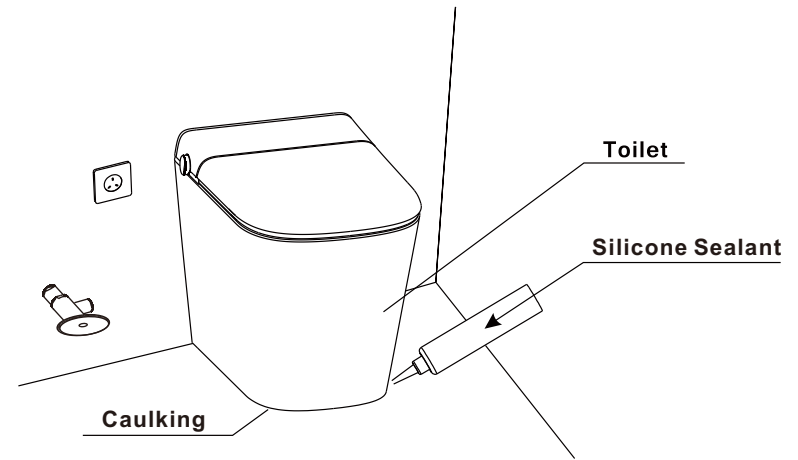

4. Connection of the water inlet hose

Connect the inlet hose with the shut-off valve & t-valve by using tools like wrench. (Valve Installation - Refer to Page 3 for Details)

● Notice: After installation, turn on the shut-off valve to check whether it leaks.

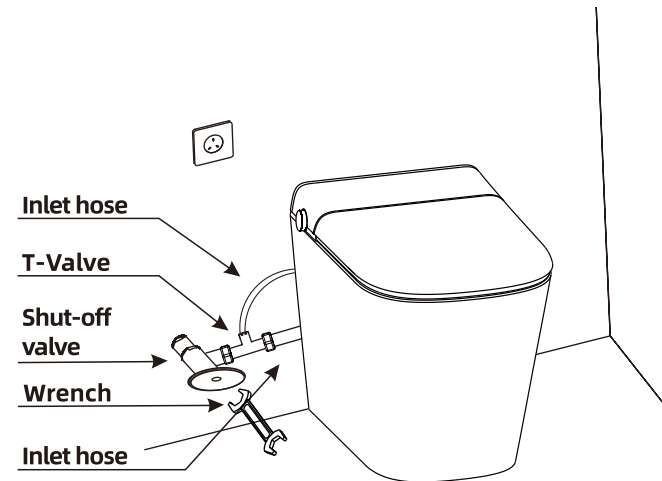

■ Installation of the Remote Control

1. Installation of remote control batteries.

Open the battery cover of the remote control and put two alkaline batteries (AAA) into the remote control one by one.

- When installing the batteries, do not reverse the positive and negative sides of the batteries.
- Do not use different or different types of batteries at the same time.
- Remove the batteries when it is not in use for a long time.

2. Confirm the installation location of the remote control.

Install the remote control in a suitable area where it is easy to get or operate when user sit on the smart toilet.

3. Install the remote control bracket on the wall.

Peel off the protective tape of 3M adhesive on the back of the bracket and apply to the selected dry tile surface.

4. Install the remote control.

Align the remote control with the bracket, insert it from top to bottom, and the installation is completed.

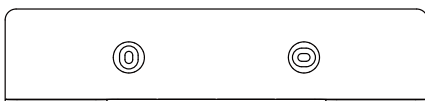
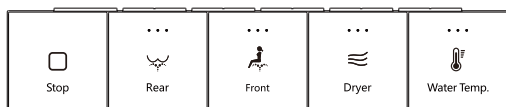

Preparation before Use

1. Open the shut-off valve

Turn the valve counterclockwise to fully open the water supply valve.

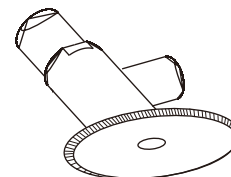

2. Plug the power plug into the outlet.

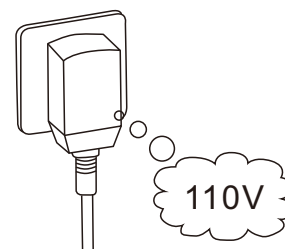

Plug the power plug into a 110V power outlet. The smart toilet will perform a self-check run once, and the main unit will be in standby mode.

- When performing a self-check, the toilet will automatically open and close the lid/ seat ring, and reset itself. It is forbidden to block it manually.
- Do not use wiring that exceeds the power supply specifications, such as an extension cord.
- The outlet must be reliably and safely grounded.

3. Adjust the cleansing water temperature and the seat temperature to the appropriate level.

4. Refer to Function Setting and Adjustment on Page 26 and use the remote control to operate various functions.

Panel Instruction

This product could be conducted mostly by remote control, assisted by the host operate panel.

◆ Remote Control Panel

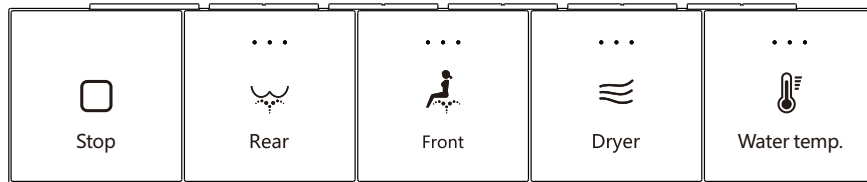

Front

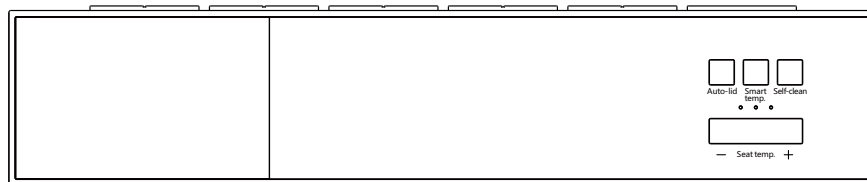

Back

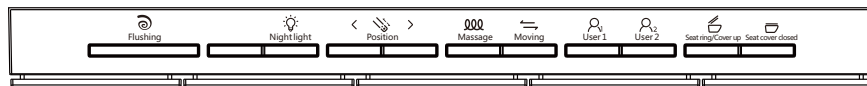

Side

● Remote control match code instruction:

1. Press the "Front cleansing" and "Dryer" buttons on the remote control while powering on, and the indicator light will flash to enter match mode.
2. Cut off and re-power on the power plug, the knob indicator light flashes twice. And then press the "stop" button on the remote control. The knob light "blue" lights up to match.
3. The knob indicator light turns to normal display, indicating successful matching. Wait for the host reset to complete.

◆ Knob button(with halo)

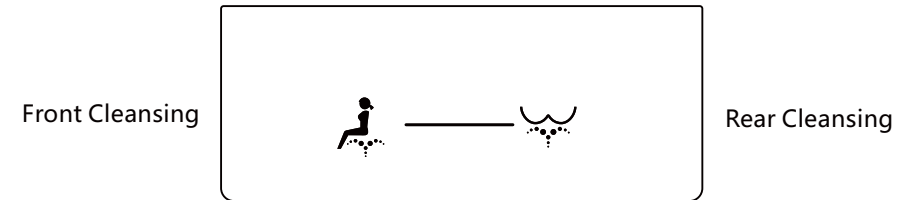



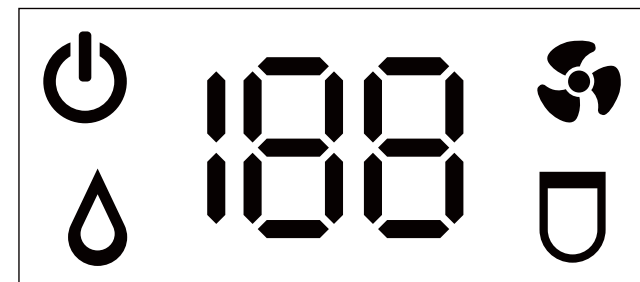

Press the knob to switch the function of flushing and stop

- Vertically pressing the knob to flush once when the smart toilet is not working.
- When on seated, rotating clockwise the knob to turn on the rear cleansing function; Rotating anticlockwise to turn on the front cleansing function; and vertically pressing the knob to stop the running function like rear cleansing, front cleansing or drying.
- When rear cleansing or front cleansing, rotating the knob once in the same direction to turn on the drying function.



■ Display Screen on the Main unit

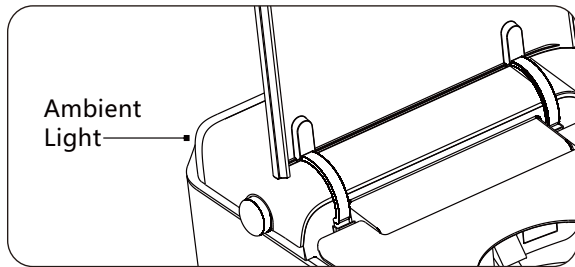

-  Power indicator: Light up when smart toilet switches on.
-  Temperature level: Show the setting temperature when smart toilet switches on.
-  Air temperature icon: When the icon lights up, it will show the setting air temperature.
-  Seat temperature icon: When the icon lights up, it will show the setting seat ring temperature.
-  Water temperature icon: When the icon lights up, it will show the setting water temperature.
- The temperature showed on the screen is the setting temperature. It will circularly show the water temperature, seat temperature and air temperature with 30 seconds interval.
- When the human body leaves the toilet sensor area, the screen will be automatically turned off after about 30 seconds.

◆ Ambient light



- Default ambient light mode 1: Lights up when the toilet seat cover is opened and turns off after the toilet seat cover has been closed for more than 30 seconds.
- Long pressing the Night Light function button on the remote control to set on/off of the atmosphere light. Power off memory on/off and setting mode.
- Within 5 seconds after turning on the atmosphere light, press the remote control " " and " " keys to switch the atmosphere light mode. The display will display 1-64 mode. After selecting the mode, you can press the stop button of the remote control to exit.

How to Use

■ When Sitting on the Seat Ring

- ◆ Upon hearing the "beep" sound, the various functions of the smart toilet will begin to start up.
- ◆ The nozzle will clean itself automatically.

■ Start Rear Cleansing or Front Cleansing Function

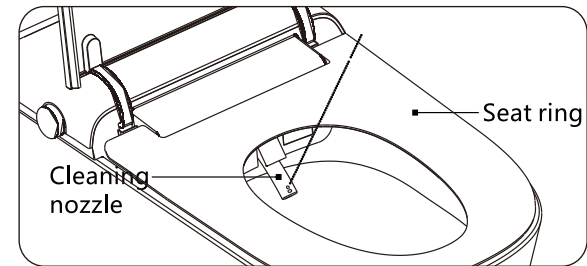

- ◆ Start the rear cleaning or front cleaning function by remote control.
- ◆ Adjust the cleaning position and water pressure by remote control.
- ◆ Start drying function by remote control.
- ◆ Press "Stop" button, rear cleaning, front cleaning or drying stops working.

■ When standing up from the seat

- ◆ Auto flush the toilet once.

Function Setting and Adjustment

■ Auto-open the seat cover

When get close to the toilet, the lid will auto-open. Pressing the button of  on remote control to turn on/off this function.

■ Lid/Seat open

This product features automatic opening of the toilet seat cover and seat. (When someone approaches the toilet, the toilet seat cover and seat automatically open through a sensor.)

Press the button Cover Up/Seat up on the remote control to open/ close the lid and seat.

Open the seat cover and seat ring by foot sensor: Under the state of unseated, when the seat cover and seat ring are in the low position, sense the foot sensor of toilet side with foot once, the seat cover will auto-open; when the seat cover is in the high position and the seat ring is in the low position, sense the foot sensor of toilet side with foot by one time, the seat ring will open; when the seat cover and seat ring are in the high position, sense the foot sensor of toilet side with foot by one time, the seat cover and seat ring will close and the toilet will flush once. Please note that if the last operation is flushing, it won't flush again when close the seat cover.

Open the seat cover and seat ring by remote control: In the state of unseated, press the button open the seat cover and seat ring on the remote control to open or close the seat cover and seat ring. Press the button close the seat cover, the seat cover and seat ring will be closed, and the toilet will flush once. Please note that if the last operation is flushing, it won't flush again when close the seat cover.

● When the smart toilet is under the state of rear cleansing, front cleansing, flushing or other functions, the function of open or close the seat cover and seat ring can not be used.

■ Rear cleansing

This product has the function of rear cleansing by using single hole nozzle.

Pressing the button  on remote control to enter the rear cleansing state :the nozzle moves back and forth, by using single hole nozzle.

In the state of rear cleansing, pressing the button  on remote control to switch the fixed cleansing mode: the nozzle stop moving. It can be operated circularly.

● The rear cleansing function will be off automatically after 90 seconds. Pressing other function buttons to directly switch to other functions or the button  to stop the function of rear cleansing within 90 seconds.

● The nozzle will auto-clean before and after rear cleansing function.

■ Front cleansing

This product is equipped with the function of front cleansing by using a feminine hole nozzle for gentle cleansing.

Pressing the button  on the remote control to enter the moving cleansing state: the nozzle move back and forth, enjoy the gently care.

In the state of front cleansing, pressing the button  on remote control to switch the fixed cleansing mode: the nozzle stop moving. It can be operated circularly.

● Front cleansing function will be off automatically after 90 seconds. Switch to other functions or press the button  to stop it directly within 90 seconds.

● The nozzle will auto-clean before and after front cleansing function.

■ Water pressure adjustment

In rear cleansing or front cleansing mode, press the button to adjust the water pressure strength according to your preference.

● 4 levels of water pressure are available. Press the button to enter the adjustment mode and adjust it to your desired intensity.

■ Nozzle position adjustment

In the state of rear cleansing or front cleansing, pressing the button  to move the nozzle back and forth and adjust to the proper cleansing position.

● 5 levels of nozzle position are available. Pressing the button  to start this function and adjust to the proper cleansing position.

■ Water temperature adjustment

Pressing the button  on the remote control will emit a "beep" and enter the water temperature adjustment mode. Then adjust to the appropriate water temperature for cleansing.

- 4 levels of water temperature are available: normal, high, medium and low. The water temperature will switch to another level when press the button of water temperature once.

■ Hot and cold massage

Pressing the button  on remote control to start the H/C massage mode. The water temperature alternates between cold and hot, changed from normal temperature to setting level. If the setting level of water temperature is normal, it will alternating change from normal level to low level.

■ Drying function

Pressing the button  on remote control, it will dry the wet parts of body.

- The drying function will be off automatically for 3 minutes. Directly switch to other functions or press the button  to stop it within 3 minutes.

■ Drying temperature adjustment

Press the remote control button , and the main unit will respond with a "beep" sound prompt, entering the dryer temperature setting mode. Adjust the air dryer temperature to the appropriate level.

- The dryer temperature can be adjusted to 4 different levels, including room temperature, high, medium, and low levels. press the button  once to switch to another level.

■ Seat ring temperature adjustment

Pressing the button  on the remote control will emit a "beep" and enter the seat temperature setting mode. Then adjust to the appropriate seat temperature.

- 4 levels of seat ring temperature are available: normal, high, medium and low. The seat ring temperature will switch to another level when pressing the button of seat ring temperature once.

■ Night light

This product is equipped with lighting function, which is convenient for nightly use.

- Pressing the button  to turn on/off the night lighting function.

■ Nozzle cleaning

Pressing the button  on remote control, the water will flow out to clean the nozzle.

- The function of nozzle cleaning only be available when unseated.
- The nozzle cleaning function will be off for 60 seconds. Pressing the button  on remote control to finish it.

■ Power button

Long pressing the button  on remote control to close the host system.

■ Flushing by remote control

Pressing the button  on remote control to flush the toilet once.

- Flushing when in the state of cleansing, the function of cleansing will be stopped.

■ Flushing manually

Pressing the flushing rotary knob vertically, and then flushing the toilet once.

- This function would be available even if the host system is shut down.
- Flushing when in the state of cleansing, the function of cleansing will be stopped.

■ Flushing by foot sensor

Designed for men to urinate, no need to bend down to find the buttons or remote control to flush. Foot sensor can achieve flushing.

- Smart toilet uses capacitive induction technology. Using foot to lightly touch the ceramic sensor area icon, it will flush automatically after the foot left.

■ Smart power-saving mode



Starting the smart power-saving mode, the host system enters the power saving mode. Once the product is used, it will immediately return to normal mode: the seat ring automatically heats to the set temperature.

- Long press the button  on remote control to turn on or off the smart power-saving mode. The smart toilet will auto-remember the last operation when power off. Starting the smart power-saving mode, the knob light flashes 10 seconds; Closing the smart power-saving mode, the knob light flashes 4 times.



- In the smart power saving mode, the seat ring stops heating when unseated; and the seat ring is automatically heated to the set temperature level or the smart seat temperature level when seated.

■ Seat temperature adjustment

When connect the power, toilet will be set to smart seat ring temperature mode, which will adjust the seat ring temperature automatically according to the indoor temperature.

Pressing the button  on remote control to close the smart seat ring temperature mode. Long pressing the button  on remote control or re-connect the power of toilet to enter the smart seat ring temperature mode.

■ User 1 and user 2 shortcut settings

Long press the  or  button on remote control for 3 seconds to save the settings of the current status such as the nozzle position, water pressure, water temperature, seat temperature and drying temperature; When in use, press user1 or user 2 to set the toilet according to the above settings preset by the user.

Cleaning and Maintenance

■ Clean and Maintain the Power Plug

Please clean the power plug regularly. When cleaning, remove the power plug from the outlet and wipe it with a dry cloth.

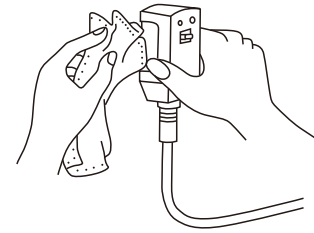

- Dust accumulation on the power plug may cause fire.

■ Clean and Maintain the Main Unit of the Smart Toilet

When cleaning the surface of the main unit, please wipe it with a soft, wet cloth.

- When cleaning and maintaining the smart toilet main unit, please pull the power plug out of the outlet to avoid any contact with water.
- If the surface has stubborn stains, you can use a soft, wet cloth with neutral kitchen detergent to clean it.

■ Clean and Maintain the Ceramic Part of the Smart Toilet

You can pour a neutral toilet cleaner onto a soft brush or sponge and use it to clean the ceramic part of the smart toilet. Rinse the area with tap water after cleaning.

- Do not use detergents or disinfectants that contain chlorine or are acidic.
- Do not use brushes that contain abrasive materials.

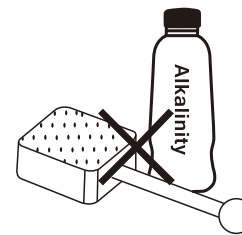

■ Clean and Maintain the Nozzle

When the smart toilet is turned on, press the remote control button  to activate the nozzle cleaning function. The nozzle will extend and clean itself with water, and you can use a toothbrush to clean it at the same time.

Please do not forcefully stretch the nozzle.

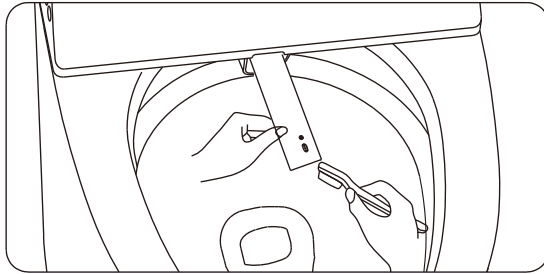

■ Clean and Maintain the Water Inlet Filter in the T-Valve

- Turn off the shut-off valve first to stop water supply.
- Remove the lock and the filter from the t-valve.
- Clean the filter with a brush or running water.
- Reinstall the filter. Make sure to screw it back in securely and not to leave behind the lock.
- Once the filter is cleaned and reinstalled, turn on the supply valve and check for any leaks. If there are any leaks, please double-check and reinstall the filter as needed.

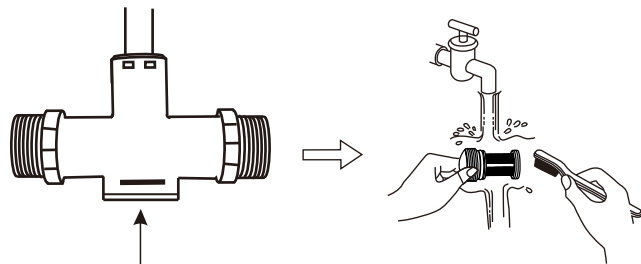

Remove the Lock and the Filter

■ When not in use for a long time

When not using this product for a long time, please be sure to drain all the water from the smart toilet to prevent water deterioration and freezing. Also, turn off the power and remove the battery from the remote control.

- (1) Close the shut-off valve and stop the water supply.

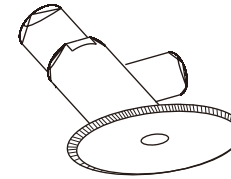

- (2) Unplug the power plug from the outlet.

- (3) Remove the water hose from the shut-off valve, drain the water from the hose, and then reinstall it.

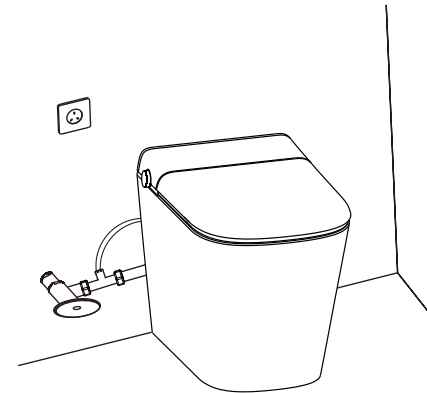

- When using again, open the shut-off valve, plug the power plug back into the outlet, turn on the power to use.

■ When Freezing Occurs

In cold seasons, the smart toilet may be damaged due to internal freezing. To prevent freezing, keep the power connected and perform the following operations:

- (1) Set the seat temperature and water temperature to the highest setting.
- (2) If the water hose inside freezes and causes the spray water to be blocked and unable to be ejected, please use a cloth soaked in warm water to warm up the water hose and slowly thaw it. You can also turn on the heater to warm up the room and let it thaw on its own.

■ When Condensation Appears

Due to the difference in temperature and humidity between bathroom and the ceramic parts/surface of the smart toilet, water droplets (condensation) may appear on the ceramic parts and surface of the main unit. Please ventilate the bathroom sufficiently to avoid condensation.

- When condensation appears, wipe it with a dry cloth.



■ Replacing the Remote Control Battery

When the remote control becomes unresponsive or the indicator light does not light up, please replace the battery with a new one.

- When installing the battery, do not reverse the positive and negative poles.
- Do not use batteries of different ages or different types at the same time.
- When not in use for a long time, be sure to remove the battery.

Troubleshooting

Some malfunctions can be resolved by simple operations. Please confirm the following items before authorizing a professional to repair the product.

Problem		Possible Reason	Solution
Press the power button and it does not work (the ambient light is not on).		Is the power outlet powered on?	Please confirm whether there is a power failure or whether the circuit breaker has tripped.
		Is the power plug switch in the off position? (Is the power plug indicator light off?)	Press the reset button on the power plug to light up the indicator light.
		Is the power plug plugged in properly?	Reconnect the power plug and insert it completely.
The remote control is insensitive or unresponsive.		Is the remote control battery dead?	Replace with a new battery.
The seat temperature, water temperature, and drying temperature are not hot enough.		Are the temperature settings appropriate?	Use the remote control to set the corresponding temperature.
The button does not respond.		During normal operation, some buttons may not respond.	Some operations cannot be performed simultaneously (such as flushing during cleansing). Please read this manual carefully.
The nozzle does not spray water or the water pressure is weak.	Alarm sound occurs.	Is the tap water turned off?	Wait for the tap water supply to be restored.
		Is the water supply valve open?	Turn on the water supply valve.
		Is the filter clogged?	Clean the filter.
	No alarm sound.	Is the water pressure too low? Is the water pressure setting on the remote control at the lowest level?	Press the button  or  to increase the water force.
		After sitting down, did you hear the prompt tone "beep"? Are you sitting within the effective range of the sensor?	Please sit on the seat and adjust to an appropriate sitting position.

Function List

CONFIGURATION FUNCTION	Item with High-level configuration
Aperient	●
H/C Massage	●
Rear Cleansing	●
Rear Cleansing with Nozzle Oscillation	●
Front Cleansing	●
Front Cleansing with Nozzle Oscillation	●
Cleansing Strength Adjustment	●
Cleansing Position Adjustment	●
Cleansing Water Temperature Adjustmengt	●
Warm Air Drayer	●
Seat Sensor	●
Seat Ring Temperature Adjustment	●
Remote Control	●
Off Seat Auto Flush	●
Foot Sensor Flush	●
Flush by Remote Control	●
Flush by Side Knob	●
Night Light	●
Nozzle Cleaning	●
Nozzle Auto Cleaning	●
User 1 and 2 shortcut settings	●
Auto Lid	●
Foot Sensor to Open the Lid	●
Buit in tank	●
Smart seat temperature	●
Ambient light	●

● Indicates this product contains the function, blank indicates no function.

Remarks : The function of different items may be different from the above list , detailed function is in accordance with the actual product.

Product Specification

Rated Voltage	110V~60Hz	
Rated Power	1300W (water intake temperature of 59°F [15°C(±1°C)], water pressure of 0.24MPa, maximum level for front cleansing)	
Power Cord Length	47.24in	
Water Pressure Range	0.15MPa (dynamic pressure) ~ 0.75MPa (static pressure)	
Overall Unit Waterproof	IPX4	
Product Dimensions	LWH: 27.95*15.74*17.91in(710*490*455mm)	
Product Weight	96 LB (43.55KG)	
Bidet Function	Water Heating Method	Instantaneous Heating
	Water Pressure	4-level adjustable
	Water Temperature	4-level adjustable: 1st level 95°F, 2nd level 100°F, 3rd level 104°F, room temperature
	Maximum Power for Water Heating	1300W
	Safety Device	Thermal Fuse
Heated Seat Ring	Heating Power	40W
	Seat Ring Temperature	4-level adjustable: 1st level 95°F, 2nd level 100°F, 3rd level 104°F, room temperature
	Safety Device	Thermal Fuse
Drying Function	Wind Speed	Greater than 8.9 mph (Greater than 4m/s)
	Heating Power	270W
	Wind Temperature	4-level adjustable: 1st level 95°F, 2nd level 113°F, 3rd level 131°F, room temperature
	Safety Device	Reversible Thermal Protector, Thermal Fuse

Acceptance Record

After the installation is complete, please test run the toilet and fill out the record sheet with the results:

Acceptance Item	Acceptance Result
Is the power outlet AC 110V \pm 10%, load \geq 1200W?	
Is the power outlet loose, or is the power connection in bad contact?	
Is each accessory securely connected without water leakage?	
Is the toilet's ambient light on?	
Is the bidet nozzle leaking?	
Is the "flip" function of the lid/seat working properly?	
Is the "rear cleansing" function working properly (including levels adjustment)?	
Is the "front cleansing" function working properly (including levels adjustment)?	
Is the "oscillating cleansing" function working properly (including levels adjustment)?	
Is the "water temperature" working properly (including temperature adjustment)?	
Is the "seat ring temperature" working properly (including temperature adjustment)?	
Is the "nozzle cleaning" function working properly?	
Is the remote control working properly?	
Is the manual and automatic flushing function working properly?	
Is the "drying" function working properly (including levels adjustment)?	
Remark:	
Retailer:	Installation personnel: Acceptance tester: Date: