

WARNING

- * Switch off the main electrical supply from the main fuse box / circuit.
- * Breaker before installation.
- * Inspect item carefully before attempting to install.
- * If there is any damages or obvious defects, do not install.
- * Item may not be returned once it has been installed.

CARE AND MAINTENANCE





- * The best and safest cleaner for a mirror is clean, warm water used with a soft cloth. Be careful not to allow the edges of the mirror to get or remain wet over a period of time.
- * If using a commercial glass or mirror cleaner, be sure to use a standard brand of glass or mirror cleaner that does not contain ammonia or vinegar. Do not use Windex. Never spray any cleaner directly on to a mirror. Instead, apply the cleaner to a soft cloth and then wipe the mirror.
- * Always use soft, grit-free cloths when cleaning a mirror to reduce chances of scratching the surface.
- * Be sure to dry all joints and edges thoroughly to be certain that no commercial cleaner comes in contact with the edges and backing.

NOTICE & IMPORTANT SAFETY INSTRUCTIONS

**** WE RECOMMEND INSTALLATION OF THIS LIGHTING FIXTURE BE DONE BY A LICENSED ELECTRICIAN ****

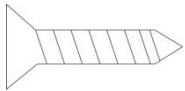
- * Please make sure that you have all parts indicated before you begin assembly of this item
- * This item should be assembled on a soft surface to prevent scratching the finish during assembly
- * To reduce the risk of fire, electrical shock or injury to persons or property, please follow the guideline below for safe use and installation
- * The external flexible cable or cord of this lamp cannot be replaced
If the cord is damaged, the lamp shall be destroyed

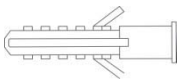
Part List and Hardware List

PIECE	DESCRIPTION	PICTURE	QUANTITY	PIECE	DESCRIPTION	PICTURE	QUANTITY
A	mounting screw		4X	C	Wire nut		3X
B	gecko		4X	D	lamp body		1X

Product Dimensions: 24"L X 32"H X 1.25"D

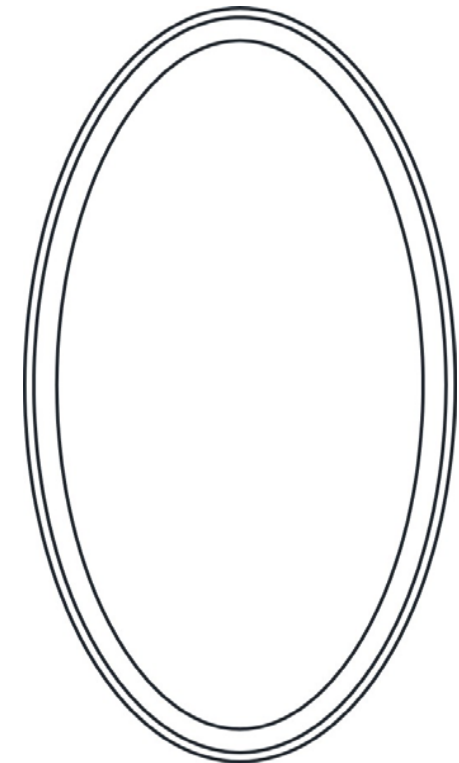

PREPARATION

- * Before beginning assembly of product, make sure all parts are present. Compare parts with package contents list and hardware contents list.
- * If any part is missing or damaged, do not attempt to assemble the product.
- * Estimated Assembly Time: 20 minutes.
- * Tools Required for Assembly (excluded): Screw driver, Pencil, Drill with 1/4" bit, Level, Measuring Tape
- * If you are having difficulty, our friendly Customer Care team is always here to help.

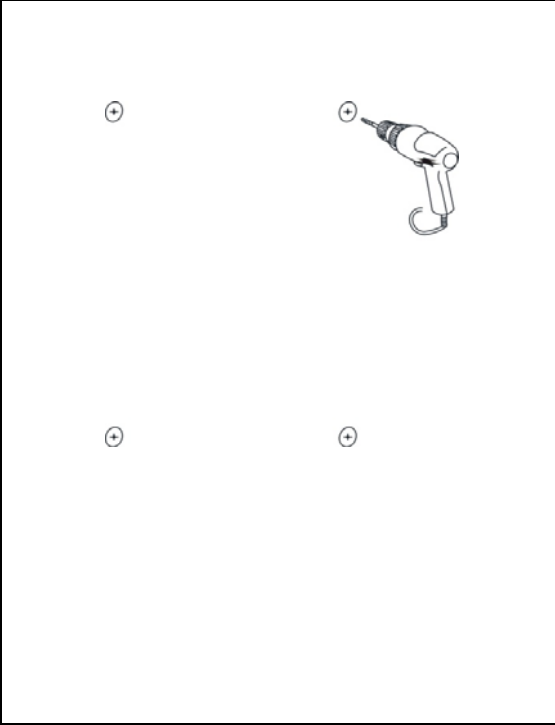

Step 1: Mark the position of hanging screw on the wall with pencil. Drill four hang holes with an electric drill and fix mounting screw with gecko.

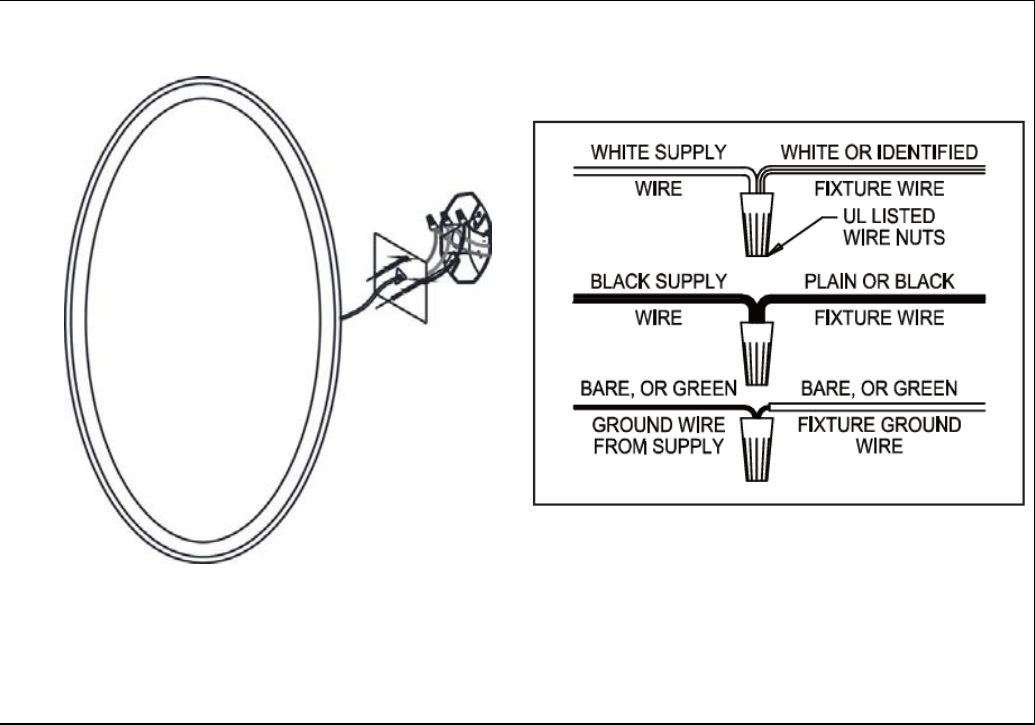

Step 2: Connect the cable to power source in wall with wire nut.

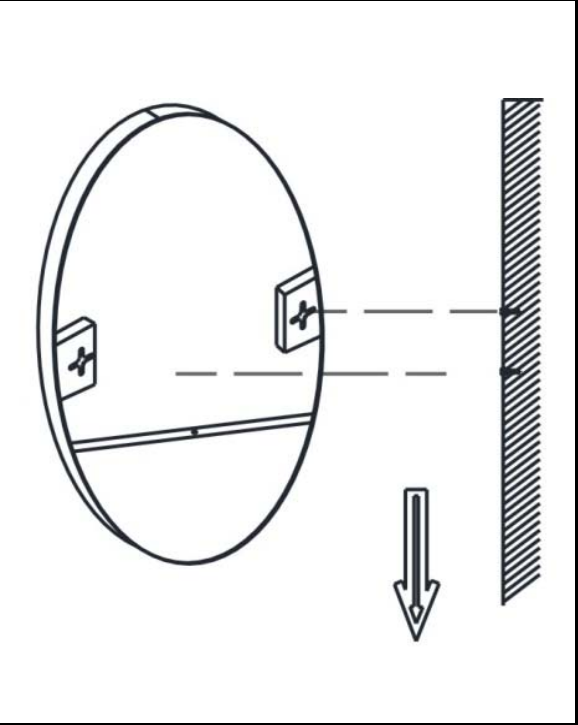

Step 3: Hang the mirror onto wall screws.