

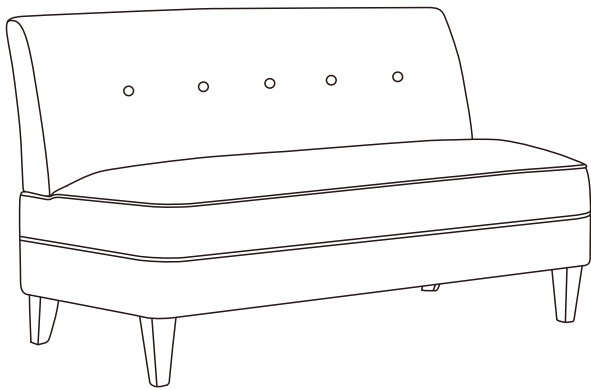

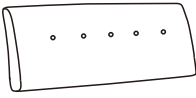



# ASSEMBLY INSTRUCTIONS



Ax1 	Ex5 
Bx1 	Fx5 
Cx2 	Gx1 
Dx2 	

1

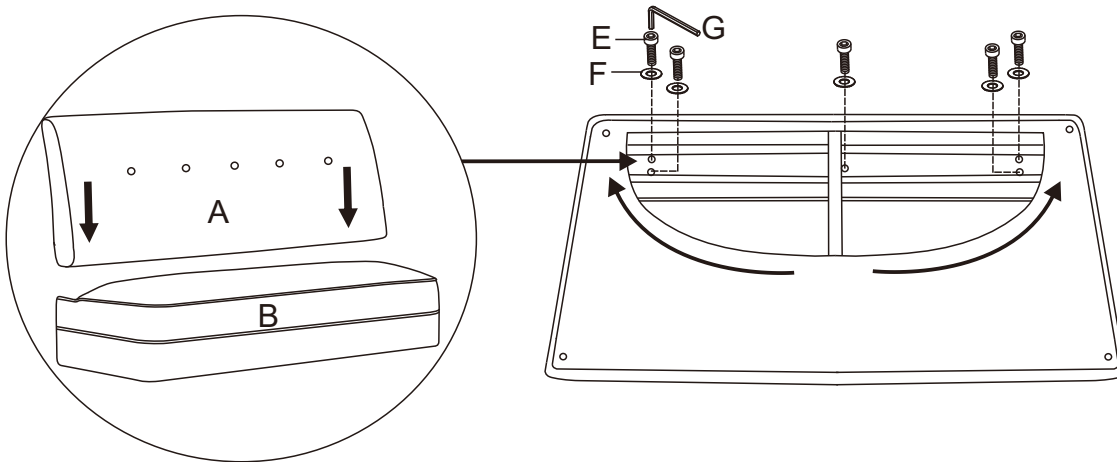

2

