

LOUNGE CHAIR

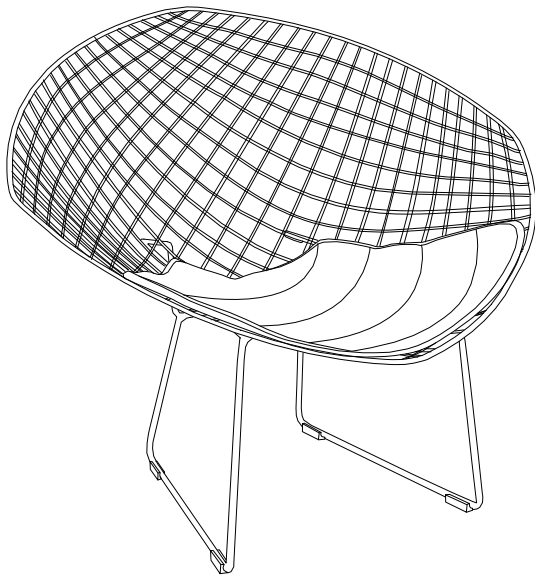



Thank you for purchasing this chair!

Before you start, here is some helpful advice:

1. We suggest you spend a short time reading through this leaflet and then follow the simple step-by-step instructions.
2. Owing to the size and weight of the chair, we recommend that it is assembled by two adults, on a carpeted or padded area, in the room that it is intended for. Approximate assembly time: 30 minutes.
3. Please do not use any tools other than those provided or recommended in these instructions.
4. Please do not throw away any of the packaging or the instruction until you have checked all the components and hardware and the furniture is fully assembled. Please ensure that the packaging is disposed of in a safe and environmentally friendly way.
5. Assemble all components loosely until advised to tighten. Depending on use, it may be necessary to tighten the components from time to time, so please save the tools that have been provided.
6. Please keep all fitting out of reach of children.

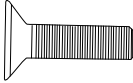

Hardware:

A		Bolt M6x25mm	x4
B		Nut M6	x4
C		Allen Wrench M5	x1
D		Open Wrench M5	x1

Component:

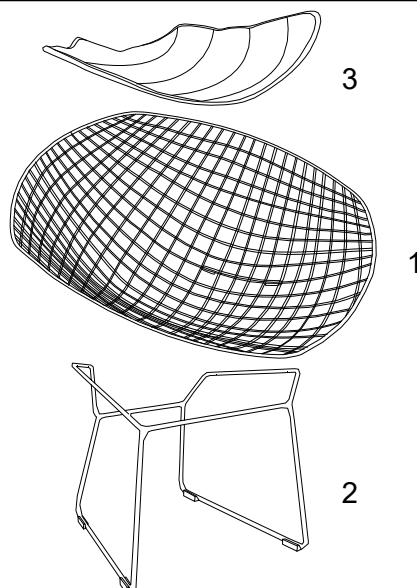

1	Chair Top	x1	2	Chair Base	x1	3	Seat Cushion	x1
---	-----------	----	---	------------	----	---	--------------	----

LOUNGE CHAIR

STEP 1:

Put **Chair Base (2)** on a carpeted or padded surface.

Place **Chair Top (1)** to **Chair Base (2)** as shown.

Insert 4 pieces of **Bolt (A)** into the pre-drilled holes on **Chair Base (2)** through the pre-drilled holes on **Chair Top (1)**.

Secure 4 pieces of **Nuts (B)** to each piece of **Bolt (A)** as shown.

Use **Allen Wrench (C)** and **Open Wrench (D)** to fully tighten **Bolts (A)** and **Nuts (B)**.

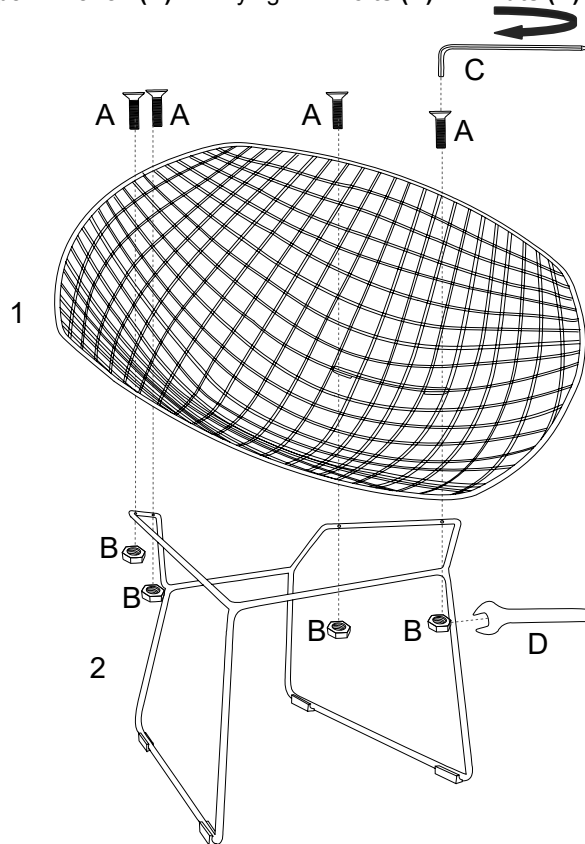

Ax4	Bx4	Cx1	Dx1

Hardware & Tools required

STEP 2:

Carefully place **Seat Cushion (3)** to the assembled **Chair Top (1)** and **Chair Base (2)** as shown.

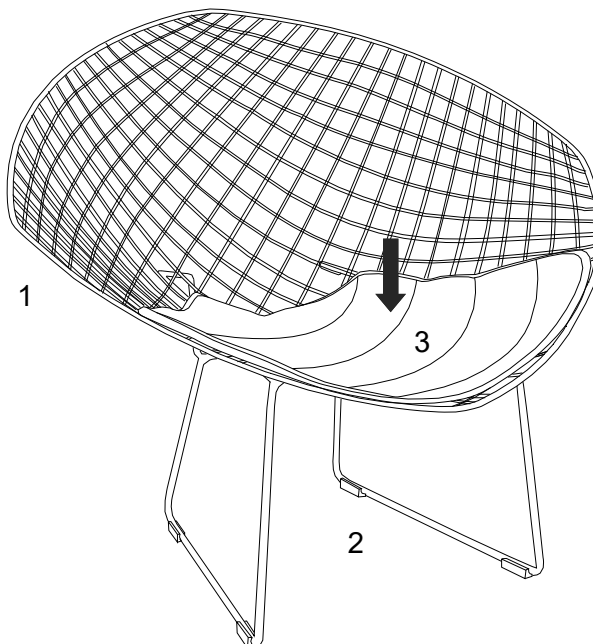

Assembly is complete. Your Lounge Chair is ready to be used now!