

# OUTDOOR CHAIRS

---

---

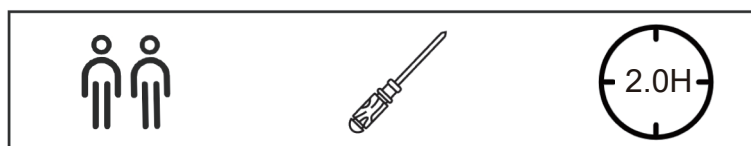

Read this instruction carefully. Refer hardware and furniture parts list for guidance. Be sure all parts are complete before assembling. Place all wooden furniture part on a clean and flat soft surface to prevent scratches. Refer steps provided as assembling guide.

# EXPLODED DRAWING:

---

---

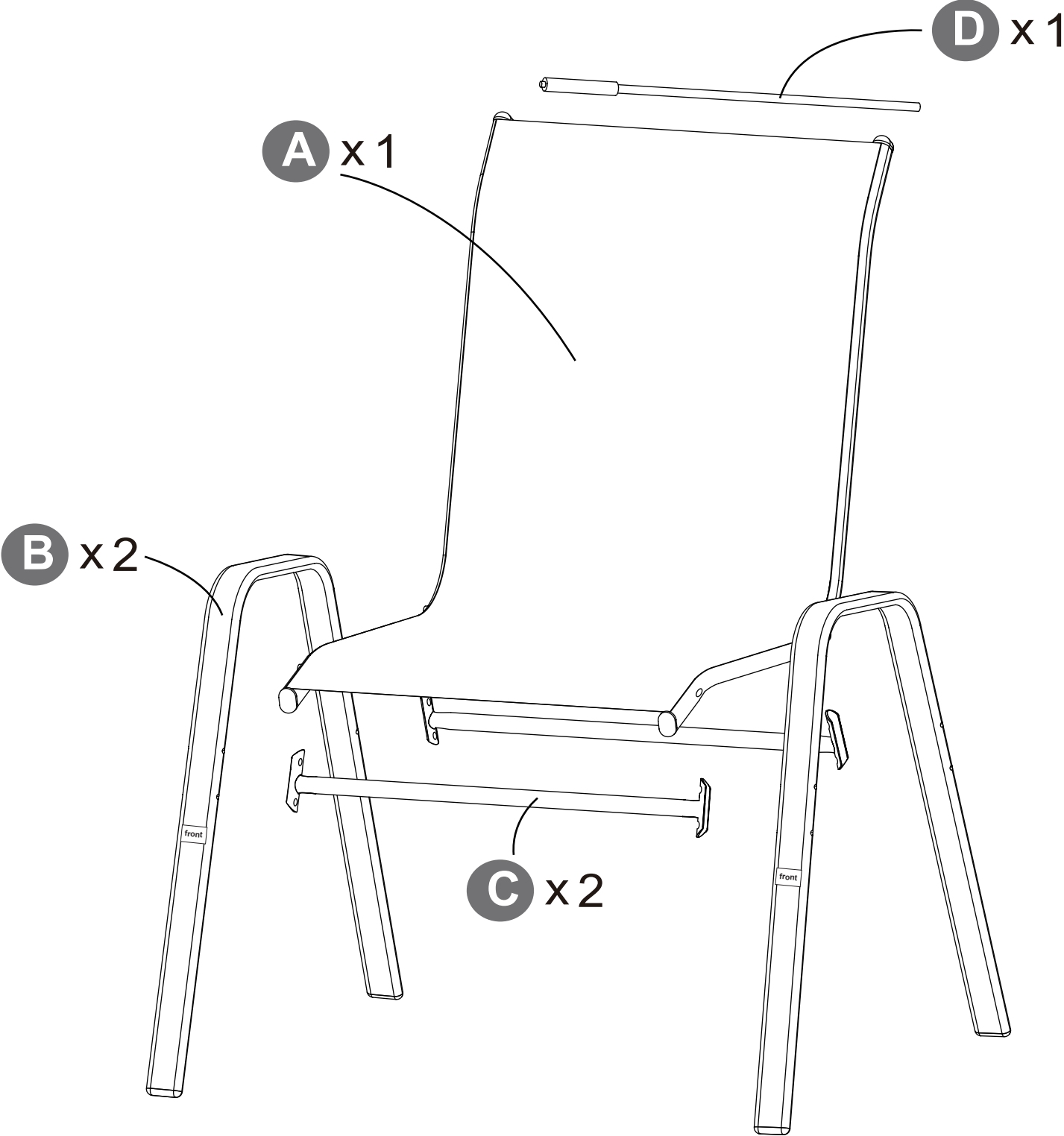

# ACCESSORY LIST

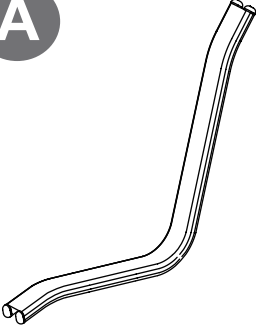
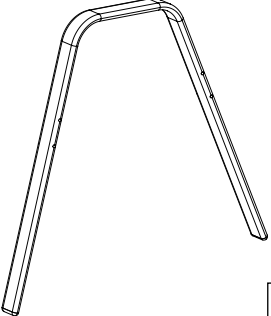
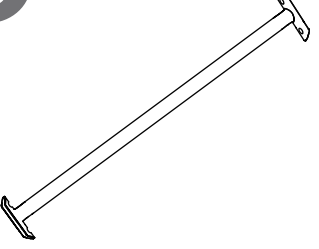
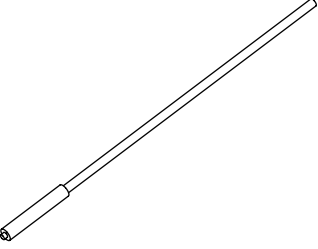
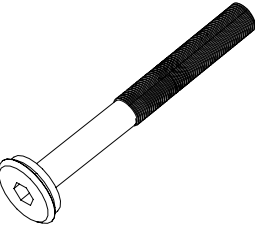
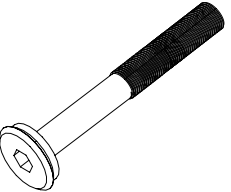
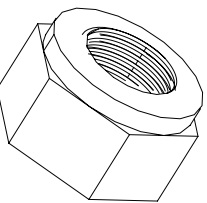
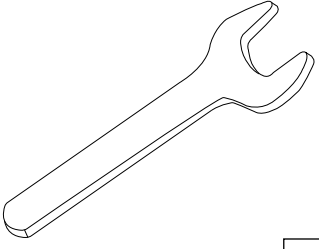
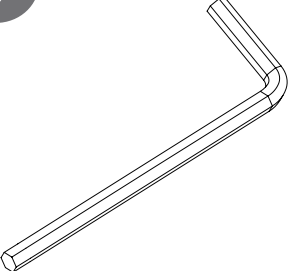
 <p><b>A</b></p> <p>x 1</p>	 <p><b>B</b></p> <p>x 2</p>	 <p><b>C</b></p> <p>x 2</p>
 <p><b>D</b></p> <p>x 1</p>	 <p><b>E</b></p> <p>M6*60MM</p> <p>x 4</p>	 <p><b>F</b></p> <p>M6*50MM</p> <p>x 4</p>
 <p><b>G</b></p> <p>x 4</p>	 <p><b>I</b></p> <p>x 1</p>	 <p><b>J</b></p> <p>x 1</p>

# STEP

1

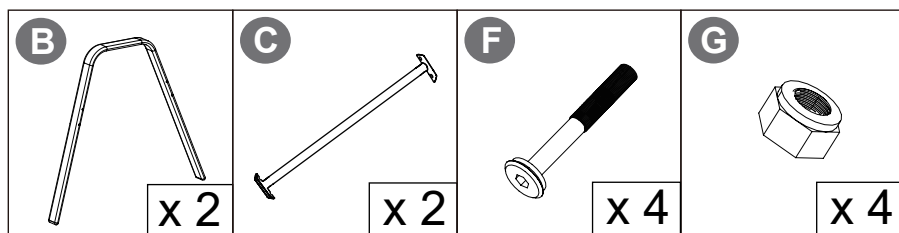

Please ensure you follow these instructions carefully during installation. It's crucial **NOT** to completely tighten the screws initially. Wait until **STEP 5** is finished before tightening all screws.

Install the four screws (F) sequentially into holes X1-4, ensuring the frame remains stable, but do **NOT** tighten them completely.

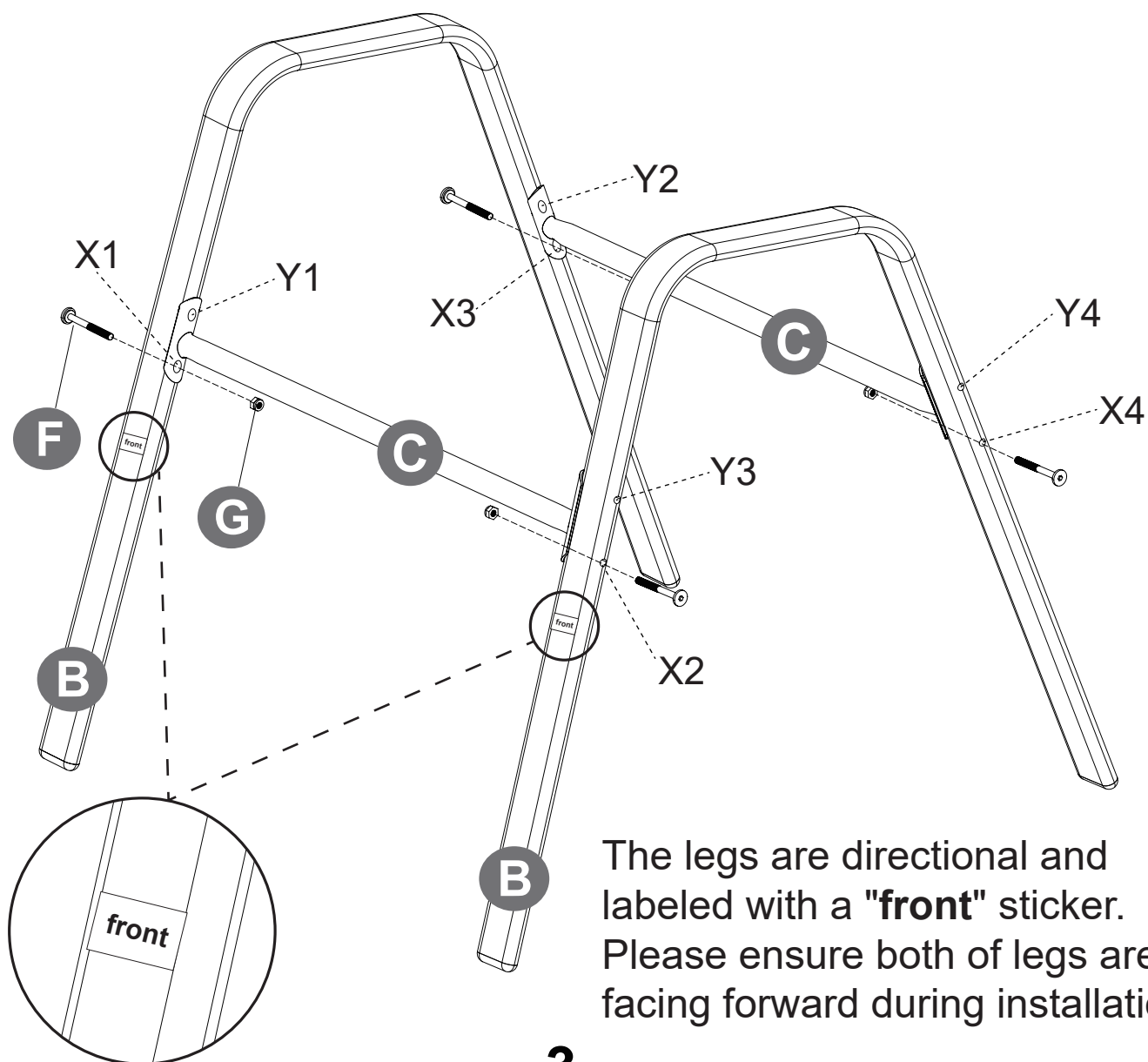

The legs are directional and labeled with a "front" sticker. Please ensure both of legs are facing forward during installation.

3

# STEP

2

Folds will disappear after being placed in the sun for 5 hours or treated with an air dryer.

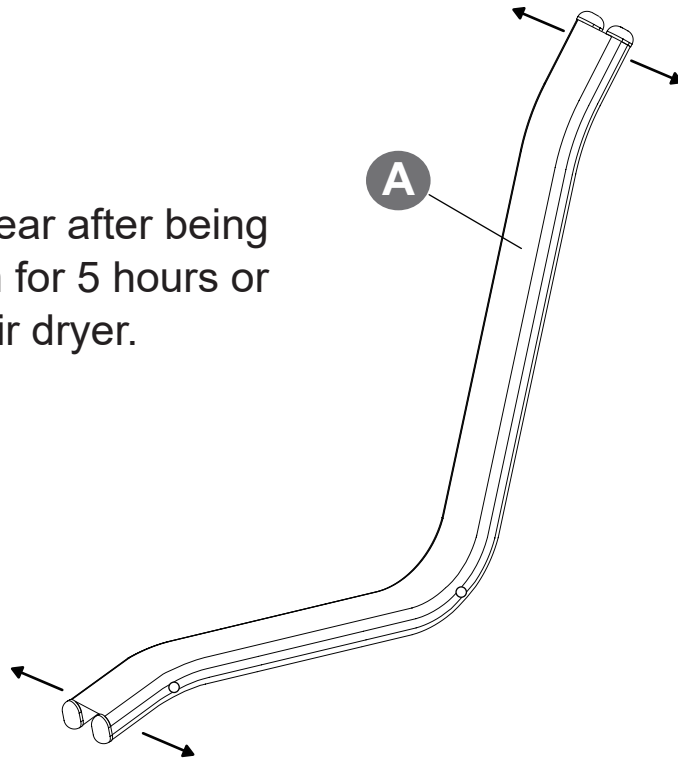

3

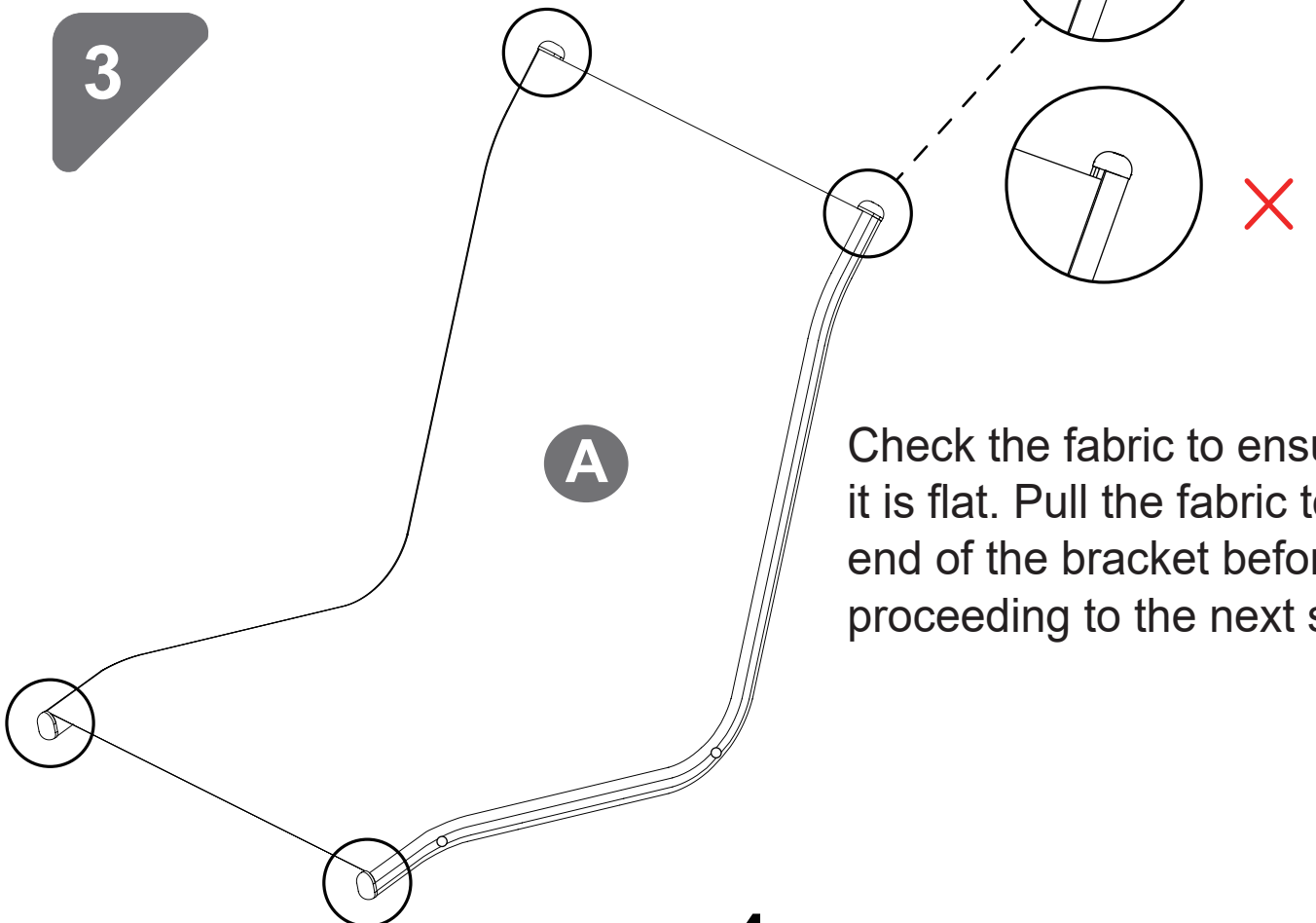

Check the fabric to ensure it is flat. Pull the fabric to the end of the bracket before proceeding to the next step.

4

# STEP

4

Look for someone to help stabilize Part A

Please ensure you follow these instructions carefully during installation. It's crucial **NOT** to completely tighten the screws initially. Wait until STEP 5 is finished before tightening all screws.

1. Install the four screws (E) into the holes Y1-4 and tighten them sequentially to 70%.
2. Check that the fabric is flat, and if it is wrinkled, repeat STEP 3.
3. Tighten the screws (E) on one side (either right or left) to 90% first. Then tighten the screws on the other side, but do **NOT** tighten them completely.

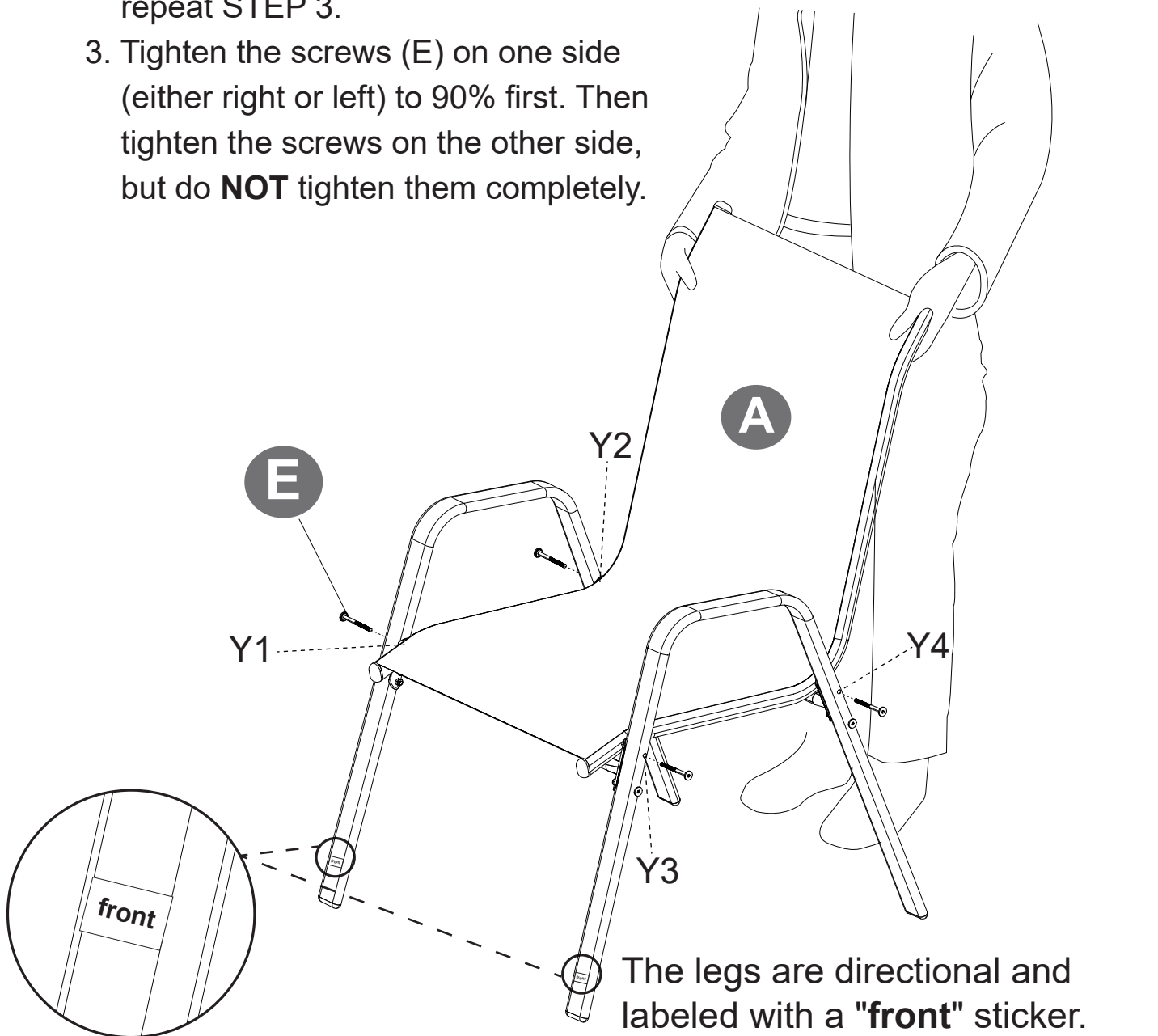
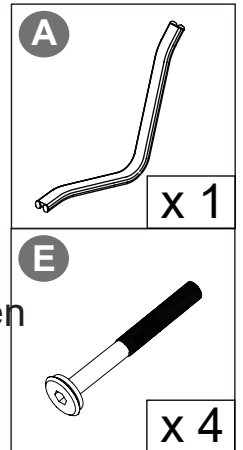

The legs are directional and labeled with a "front" sticker. Please ensure both of legs are facing forward during installation.

5

# STEP

5

Install the support bar on the back of the chair as shown, ensuring that the small end is on the left and the large end on the right.

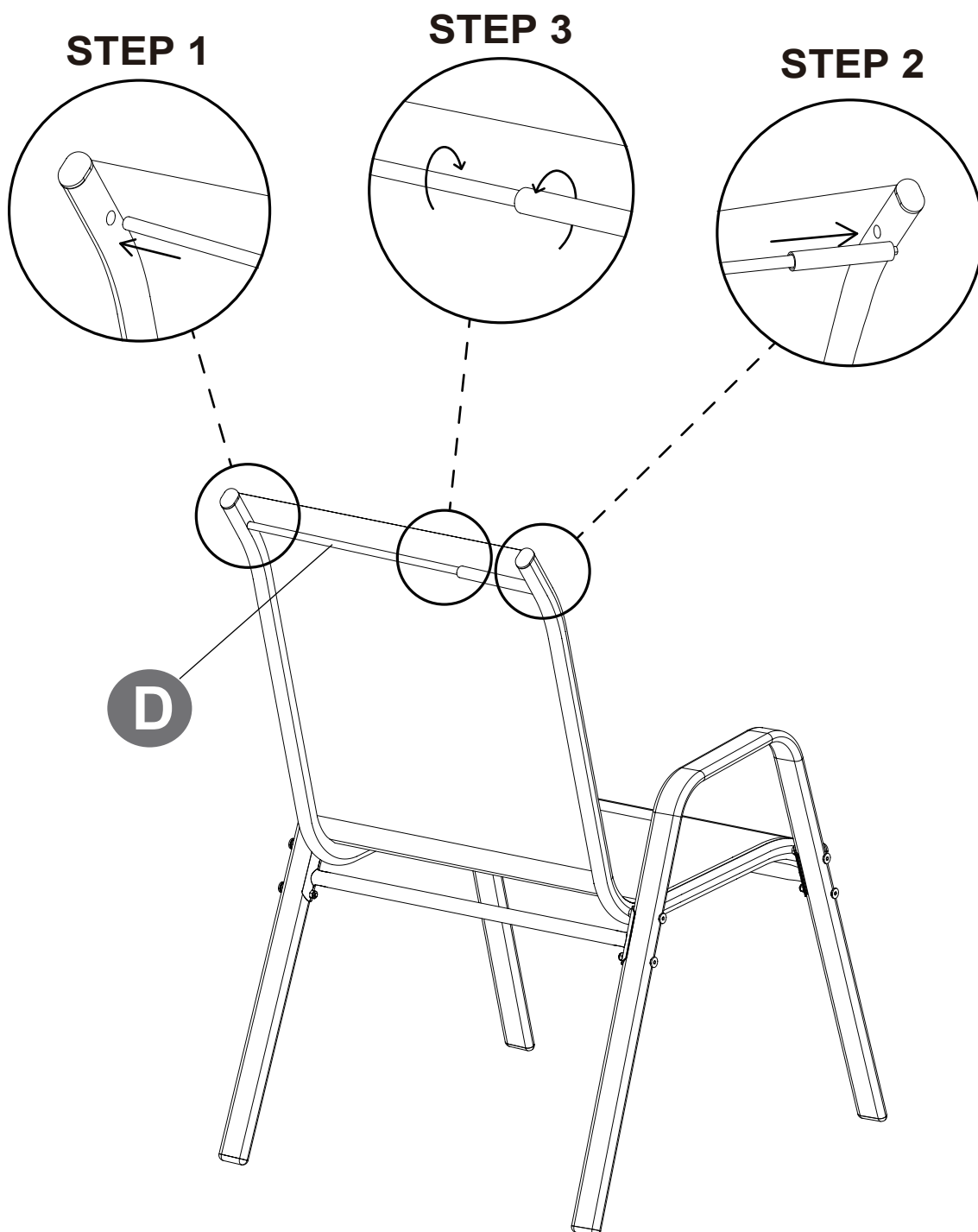
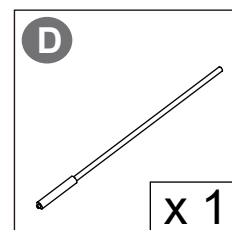

Finally, check and adjust the fabric to ensure it is completely flat. Once adjusted, tighten all screws completely.

# **AFTER-SALE**

---

---

## **AFTER-SALE SERVICE**

If you have any suggestions for our products or find that the products have quality problems, please contact us first, our after-sales team will reply you within 24 hours, and we will do our best to give you solutions until you are satisfied.