

ASSEMBLY INSTRUCTIONS

120-1107

TOOLS REQUIRED:

- Allen wrench (Provided, part # D)
- Phillips Screwdriver (not provided)

BEFORE YOU START:

1. Check the parts against the parts list to make sure all items are present.
2. Assemble your furniture on a soft, flat surface to avoid scratching the finish.
3. **CAUTION:** Do not over tighten screws, nuts or bolts during assembly.
4. Your furniture may require occasional tightening.

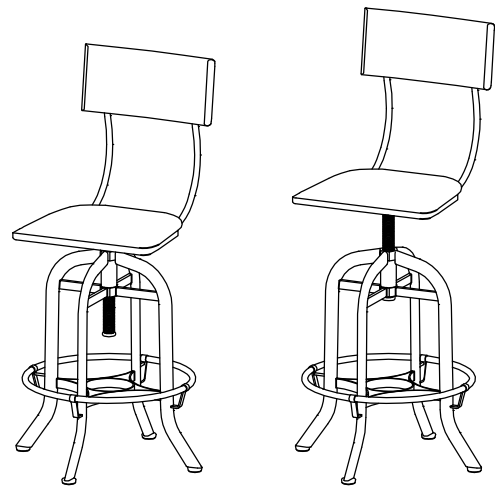

Fig 1

INSTRUCTIONS:

1. Adjust the metal bolt higher for easy to assembly as show Fig 1.
2. Put the back up side down to a box and attached the base to the back using bolt (A) spring (B) and washers (C), tighten with the wrench (D)

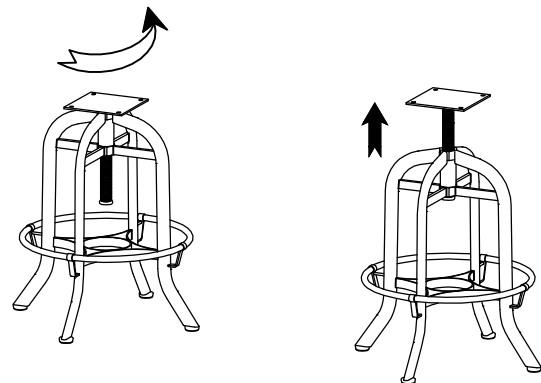
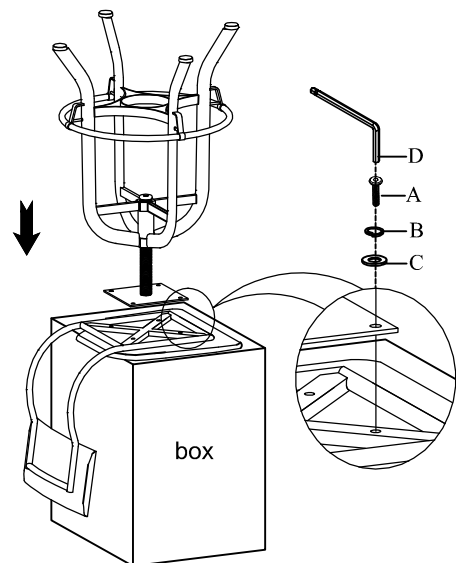





Fig 2



No.	Hardware List		Q'ty
A		Bolt (Ø1/4"×5/8")	4 pcs
B		Lock Washer (Ø1/4")	4 pcs
C		Flat Washer (Ø1/4"×16mm)	4 pcs
D		Allen Wrench	1pc