

CHAIR

ASSEMBLY INSTRUCTIONS

IMPORTANT:

Please read all the instructions and warnings before assembling.

WARNING





- All bolts shouldn't be tightened until the complete piece is assembled (This will make the assembly process much easier). Once the piece is fully assembled, then go back and tighten all bolts with provided tool.
- Keep all children and pets away from assembly area.
- Keep assembly area at least 6 feet from any obstruction such as a fence, garage, house, overhanging branches, laundry line or electrical wires.
- Some parts may contain sharp edges. When assembling and using this product, basic safety precautions should always be followed to reduce the risk of personal injury and damage to the product.
- The chair is not to be used for standing purposes and will not function as a stool or step-ladder. Use on even surfaces only.
- The chair is not a toy. Proper use of the chair is for single person seating only. Chair tested for use at weight of 350 lb. Improper use of this product or failure to use as directed may result in injury. Not intended for commercial use.
- Warranty: One year limited warranty. Proof of purchase (dated register receipt) is required for warranty claims. It remains the customer's responsibility for freight and packing charges to and from the service center.

CARE & MAINTENANCE

- **STAIN RESISTANT CUSHIONS CARE** — **KEEP THE CUSHIONS IN STORAGE ON RAINY DAYS.**
- **SPILLS:** Immediately wipe up the spill using a white damp cloth. Repeat process if necessary until stain is gone. Allow cushion to air dry.
- **FABRIC CARE:** Wash with cold water when needed. Hand wash with chlorine free bleach, lay flat to dry, use cold iron compress if necessary, do not dry clean.
- **ALL WEATHER WICKER PRODUCT CARE**

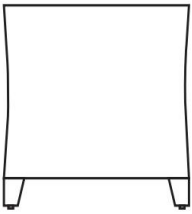
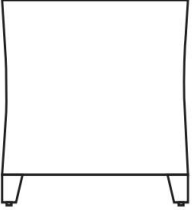
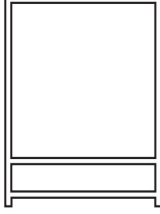
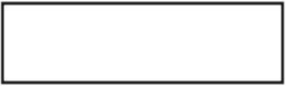
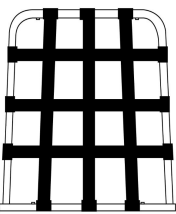
When not in use, wipe free of any dirt or loose objects, wash with a mild solution of soap and water, rinse thoroughly and dry completely. Do not use strong detergent or abrasive cleaners. Bolts can loosen over a period of usage, please check the bolts occasionally and re-tighten if necessary.

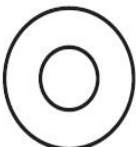
ASSEMBLY INSTRUCTIONS

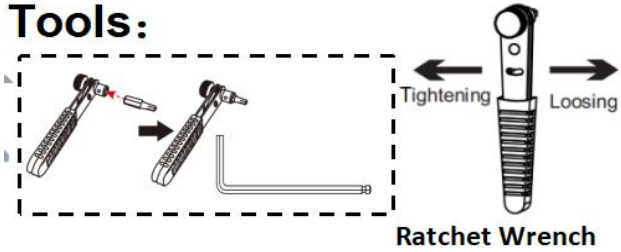

AL  1PC Left Arm	AR  1PC Right Arm	B  1PC Chair Back	C  1PC Front Panel
D  1PC Seat Panel	J  M6*35mm 4PC Bolt	K  M6*32mm 8PC Bolt	N  12PC Washer
O  1PC Allen Wrench			

Tools:



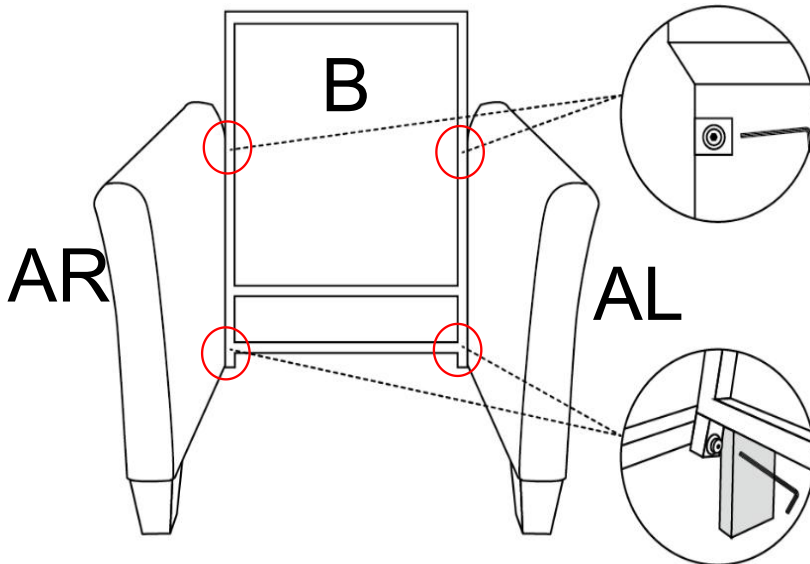

1. Keep the bolts loose.



K		M6*32mm	4
N		Ø16*Ø6.5*1mm	4

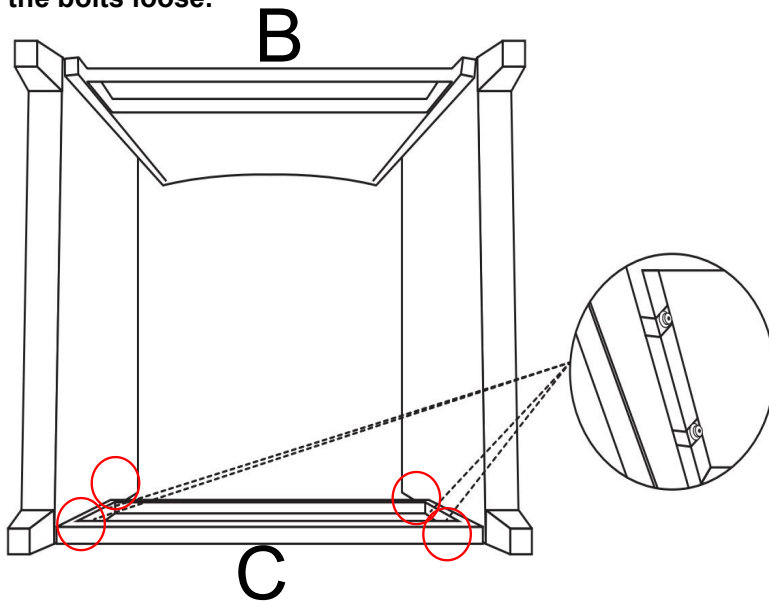

2. Keep the bolts loose.

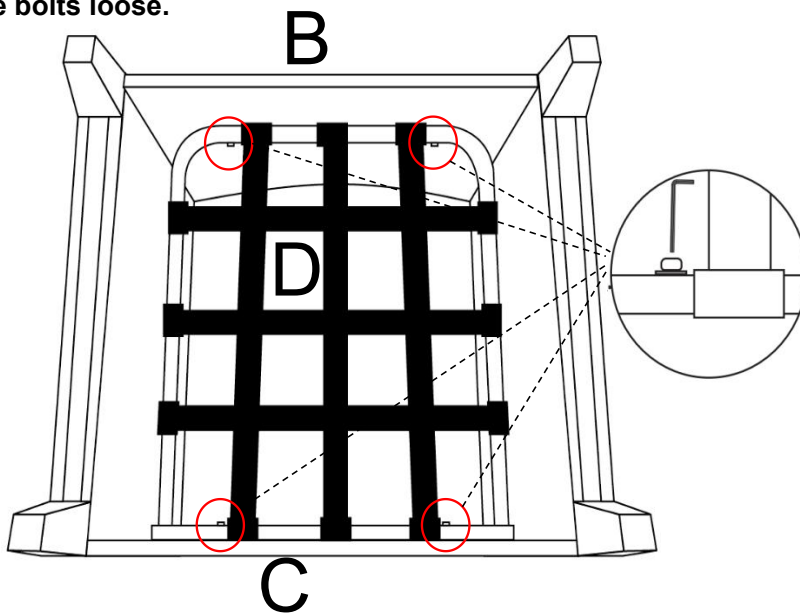

K		M6*32mm	4
N		Ø16*Ø6.5*1mm	4

3. Keep the bolts loose.



J		M6*35mm	4
N		Ø16*Ø6.5*1mm	4

4. Tighten all bolts,
put the cushions onto the chair.

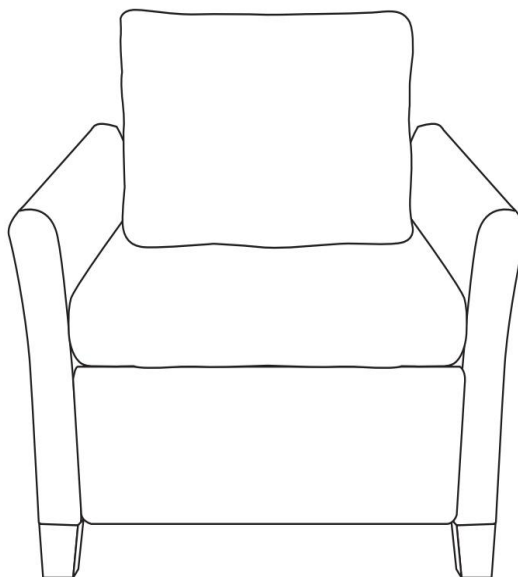

Warranty

We are committed to providing quality outdoor furniture and offer a one-year limited warranty on this product.

Terms and Conditions

This warranty covers defects in materials and workmanship under normal use and care for a period of one year from the date of purchase. Proof of purchase (dated receipt or invoice) is required for all warranty claims.

Customer Responsibilities

The customer is responsible for all freight and packing charges associated with returning the product to our service center and shipping it back after repair or replacement.

Exclusions

This warranty does not cover:

Normal wear and tear, including scratches, stains, fading, or discoloration.

Damage caused by misuse, accidents, neglect, or improper maintenance.

Damages resulting from exposure to extreme weather conditions.

Commercial use of the product.

How to File a Claim

To submit a warranty claim:

Provide proof of purchase. Include a detailed description of the issue and photos, if applicable.

Contact our customer service team for assistance. If your claim is approved, we will repair or replace the product or provide a

comparable solution at our discretion.

This warranty is non-transferable and applies only to the original purchaser. For optimal product performance, we recommend following all care and maintenance instructions.