

ASSEMBLY INSTRUCTIONS

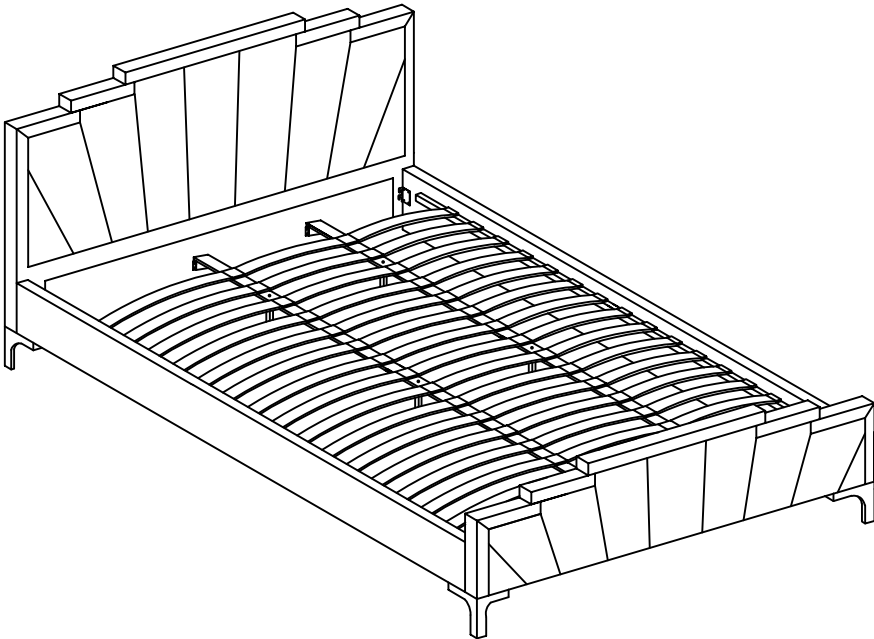

TOOLS REQUIRED



Allen Wrench

(Included)

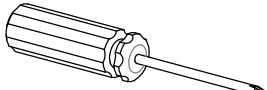

Phillips Screwdriver

(Not Included)



2 - People Recommended

ASSEMBLY RATING



EASY —————> DIFFICULT

The Assembly Rating is a 5-point system showing the level of effort needed to assemble a specific product.



CHECK BEFORE STARTING

Are you missing anything?

Double-check all parts, hardware and accessories listed are all accounted for.

Check out our Quick Tips!

We recommend reviewing the pre-assembly handouts. Even experts need a refresher now and then!

Should we send any replacements?

Are there any irregularities or flaws in the parts? We can send replacements!

Prep Time!

Please review the assembly instructions and all diagrams prior to assembling.

PRE ASSEMBLY INTRODUCTION

We understand building ready-to-assemble furniture can be a challenging experience for some. To help avoid confusion, we have provided some helpful tips that may speed up the process.



Teamwork

ALWAYS have at least two people to help with transporting and assembling the product to avoid potential injury and/or damage.



Suitable Location

Assembling near the area of the intended location is highly recommended.



Sufficient Space

Make sure you have enough space to move around during the assembly.

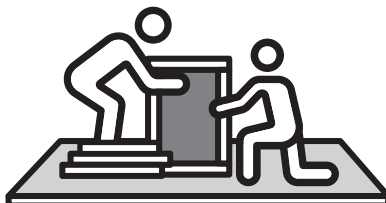

Avoid Scratches

Use cardboard, blankets or a carpeted area while assembling furniture to prevent to prevent scratches and damages.

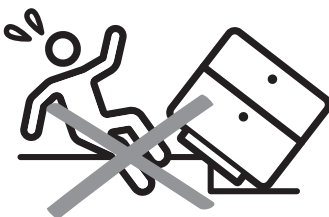

Flat Surface

Make sure the furniture rests on a flat and level surface with each leg evenly touching the floor.

ASSEMBLY AND CARE ADVICE



FAILURE TO FOLLOW THE GUIDELINES BELOW MAY RESULT IN INJURY AND/OR PROPERTY DAMAGE.



Position each part correctly and insert screws or bolts into their respective holes.



Use the appropriate hand tools or power tools for assembly. Select steps, such as tightening screws and/or bolts, may require hand tools to avoid causing damage during assembly.

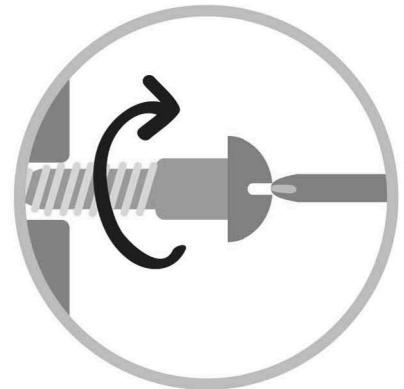

Turn clockwise to tighten and only tighten when step is completed or when instructed to do so.



Save the instructions and store any supplied tools for later maintenance.



After two weeks, check and tighten any loose hardware and repeat again every six months thereafter.

IT IS THE USER'S RESPONSIBILITY TO MAINTAIN THE FURNITURE. THE HARDWARE MAY LOOSEN OVER TIME AND MAY CAUSE THE FURNITURE TO BE WOBBLY AND UNABLE TO SUPPORT ITS INTENDED WEIGHT CAPACITY. THIS MAY LEAD TO COLLAPSE AND MAY CAUSE SERIOUS INJURY.

CALIFORNIA KING BED



- Please keep instructions for future reference.
- Check the quantity and irregularity of parts and hardware before you start.

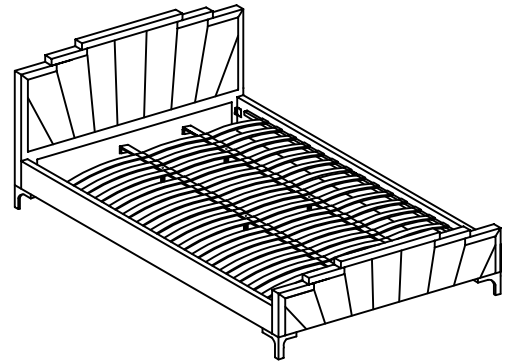

PARTS

#1 x 1pc

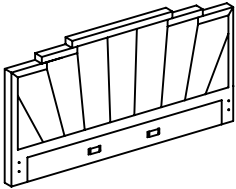

Headboard

#2 x 1pc

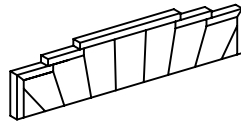

Footboard

#3 x 2pcs

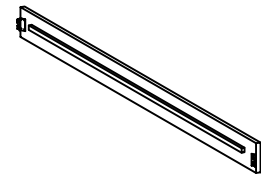

Side Rail

#4 x 4pcs

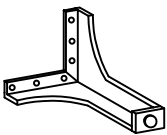

Legs

#5 x 2pcs

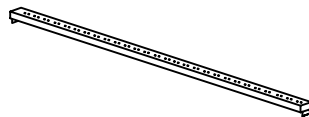

Center Rail
2165mm

#6 x 4pcs

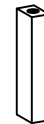

Bed Slat Support
215x30x30mm

#7 x 45pcs



Bed Slat
609mm

#8 x 30pcs



Middle Holder

#9 x 30pcs



End Holder

HARDWARE

#A x 8pcs

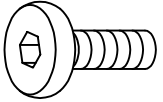

JCBB M8x20mm

#B x 4pcs

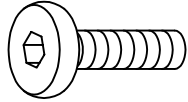

JCBC M6x40mm

#C x 1pc

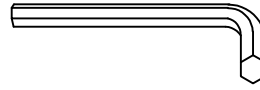

Allen Wrench
M4 x 65mm

#D x 1pc

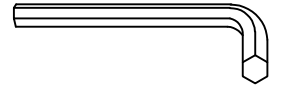

Allen Wrench
M5 x 70mm

#E x 16pcs

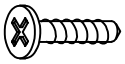

CSK Screw
M4 x 25mm

#F x 12pcs

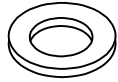





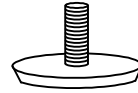



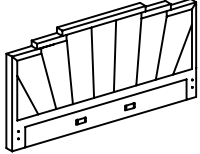
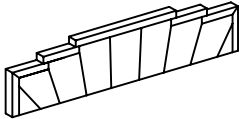

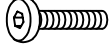

M6 Flat Washer

#G x 4pcs

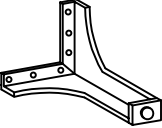
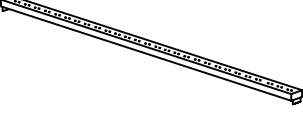

Adjuster

Carton	Designation	Part		Hardware
	Headboard	#1		
	Footboard	#2		
	Side Rail	#3		 #A x 8pcs  #B x 4pcs  #C x 1pc  #D x 1pc  #E x 16pcs  #F x 12pcs  #G x 4pcs
	Legs	#4		
	Center Rail	#5		
	Bed Slat Support	#6		
	Bed Slat	#7		
	Middle Holder	#8		
	End Holder	#9		

ASSEMBLY INSTRUCTIONS

1

- Part #1 x1pc
- Part #2 x1pc
- Part #4 x4pcs
- Hardware #E x12pcs
- Hardware #F x12pcs

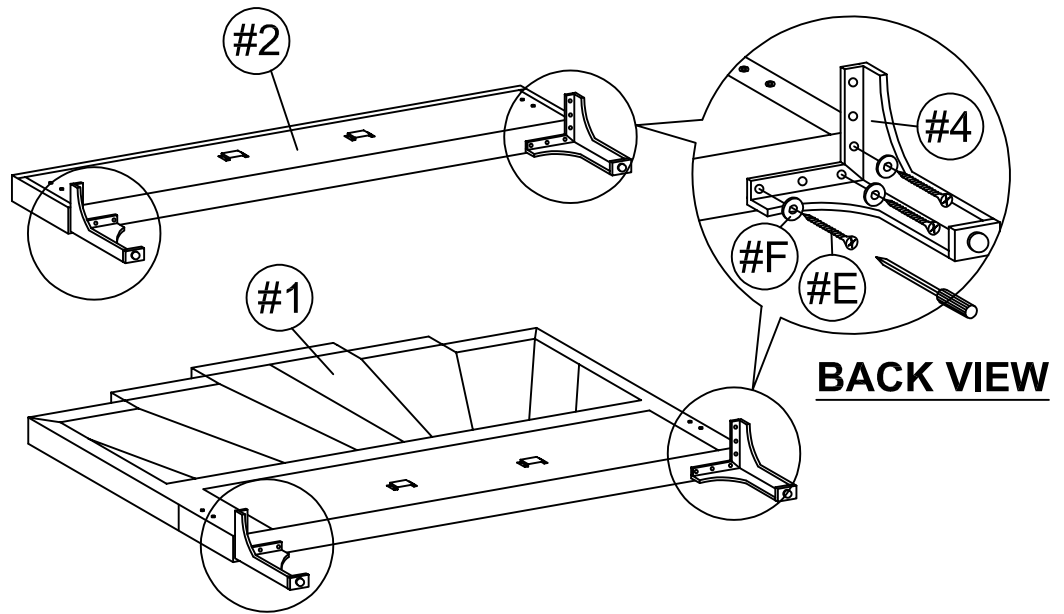

2

- Part #3 x2pcs
- Hardware #A x8pcs
- Hardware #D x1pc

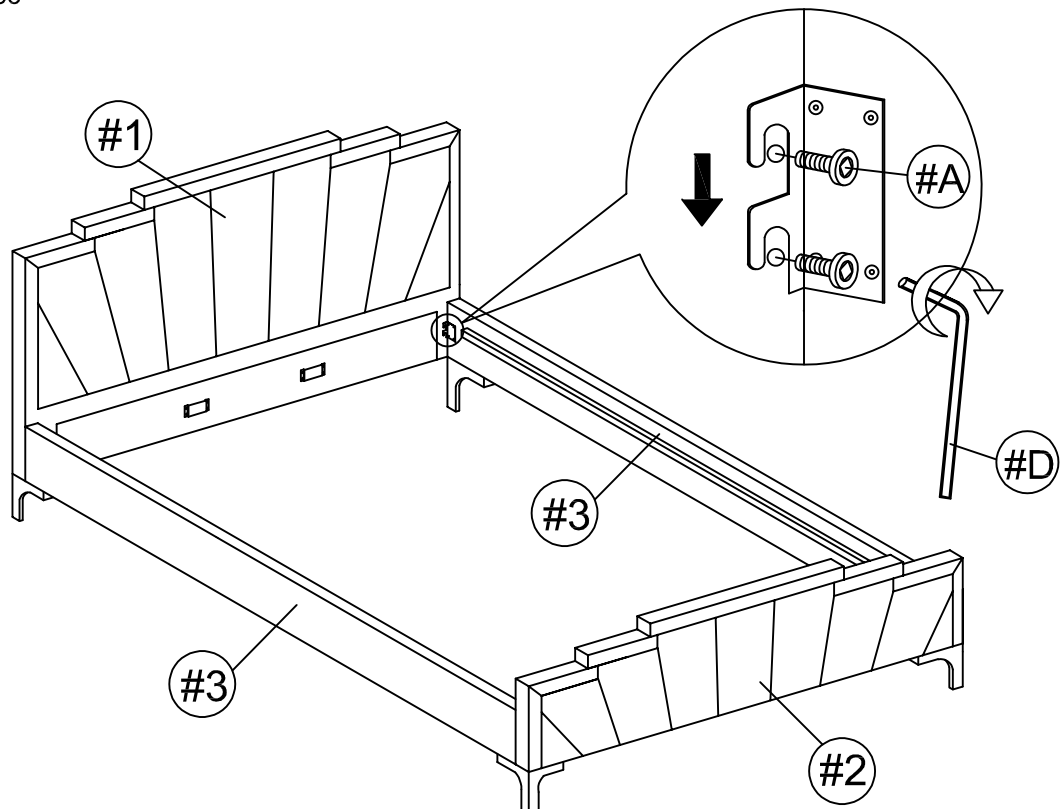

ASSEMBLY INSTRUCTIONS

3

Part (#5) x2pcs

Part (#6) x4pcs

Hardware (#B) x4pcs

Hardware (#C) x1pc

Hardware (#G) x4pcs

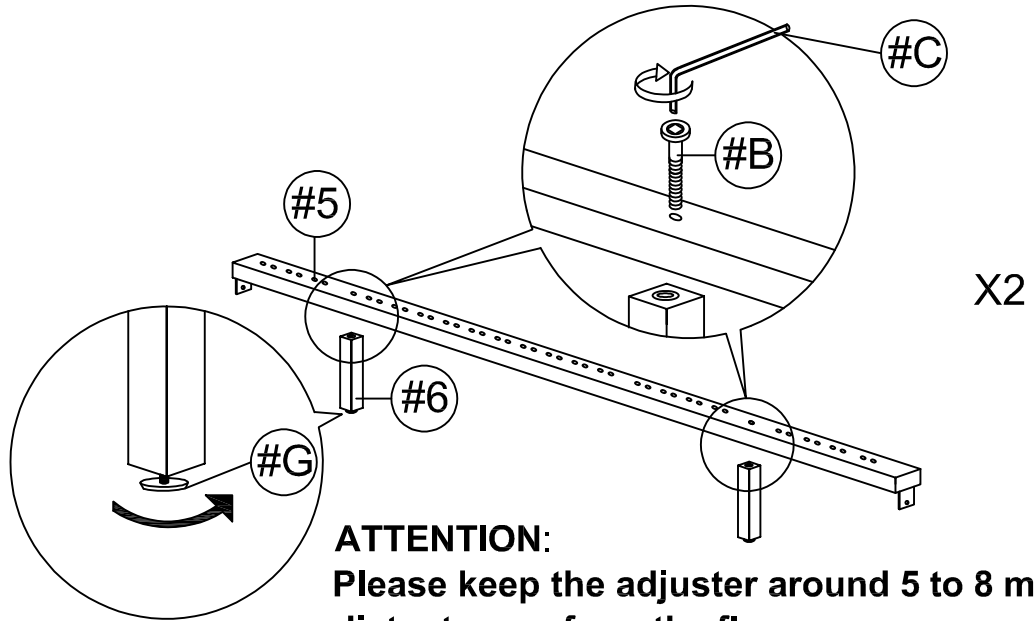

4

Hardware (#E) x4pcs

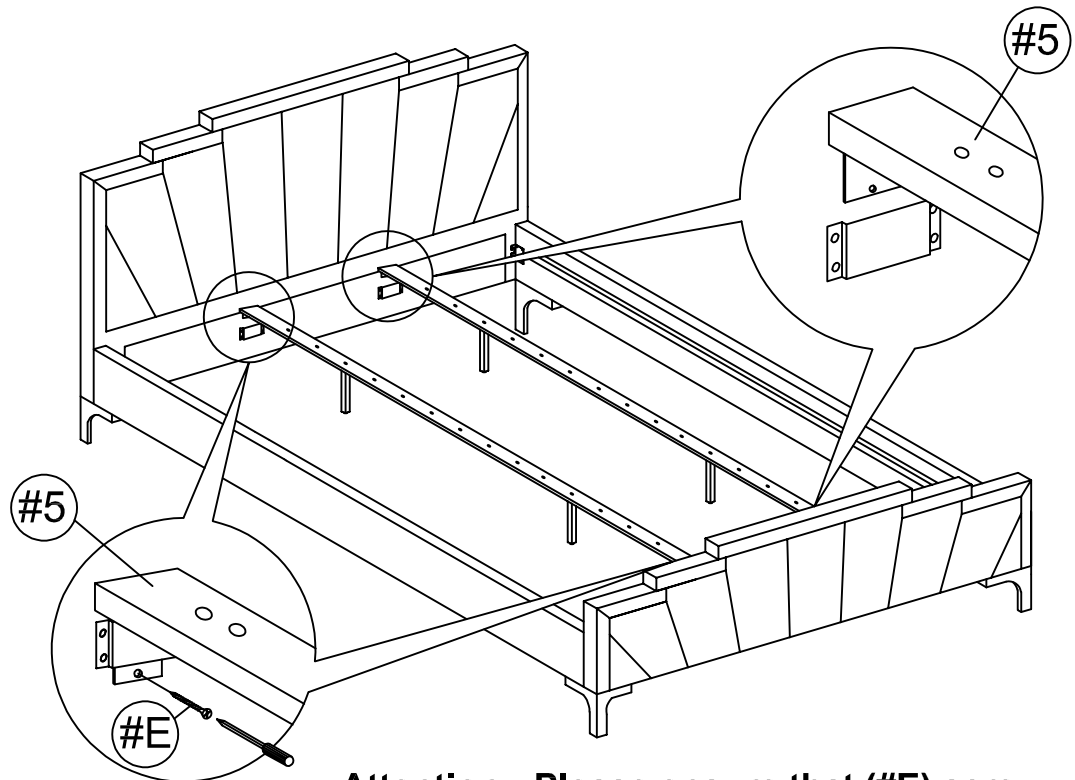

Attention : Please ensure that (#E) screw is being attach as per the A.I shown to avoid base being collapse .

ASSEMBLY INSTRUCTIONS

5

Part #7 x45pcs

Part #8 x30pcs

Part #9 x30pcs

Hardware #D x1pc

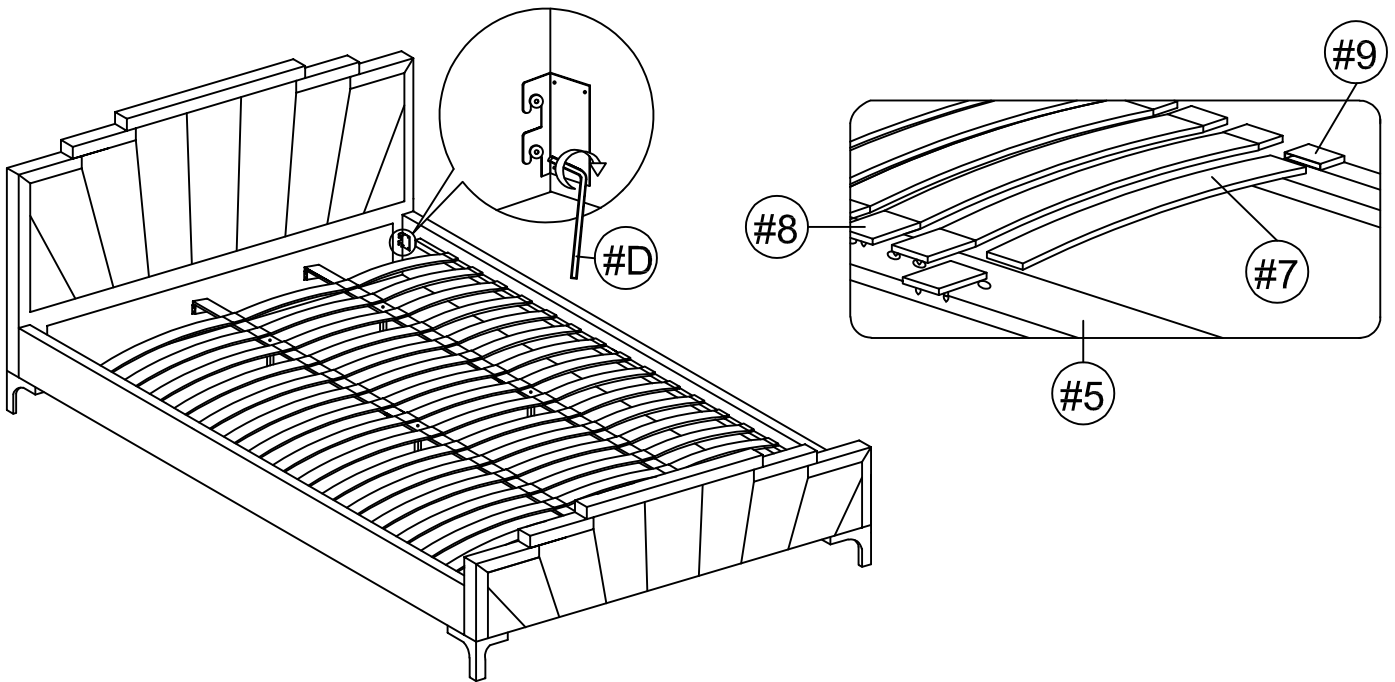

ASSEMBLY COMPLETED



Please ensure the furniture rests on an even and flat surface. If the product wobbles or feels loose, double-check all bolts and/or screws are properly tightened and secured.

✓ Keep this handy!

Please retain this instruction manual and any order-related information for future reference.

✓ Lift, don't drag!

To avoid damage to product please always LIFT the product when transporting or adjusting the placement.