

# OWNER'S INSTALLATION GUIDE

Please read and save these instructions

## 52" Ceiling Fan

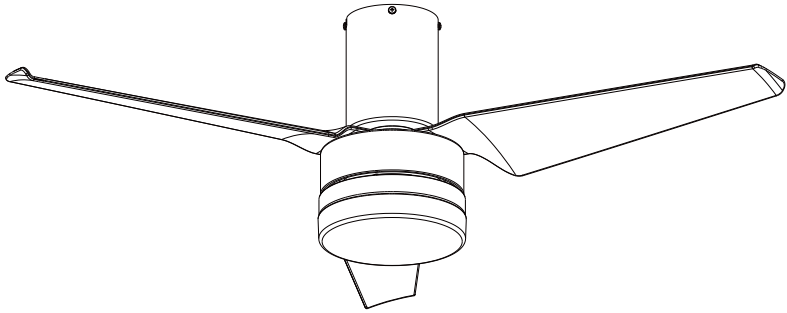

Please read and follow all the instructions carefully before using this product.

**The product image shown here is indicative only.**

**Actual product you receive may differ.**

# Important: Please read and save these instructions before installation

## Basic Product Specifications

		Voltage	120V
Fan Blade Span	52"	Rated Wattage	48W (Fan 26W / Lamp 22W)
Gross Weight	11.9 lbs.	Motor RPM	45-165 RPM
Maximum Airflow	4500 CFM	Maximum Noise	58 dB(A)

# Live Smarter

This Smart Ceiling Fan is :



ETL certified  
and suitable for  
indoor use only

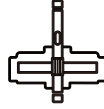

DC Motor  
10-speed, ultra-quiet,  
reversible &  
energy efficient



Connect via Wi-Fi  
or Bluetooth for  
advanced control



Compatible with  
smart devices

# SAFETY PRECAUTIONS

---

## READ AND SAVE THESE INSTRUCTIONS

- Before you begin installing the fan, shut power off at the circuit breaker of the fuse box.
- Make sure that all electrical connections are in accordance with National Electrical Code, ANSI/NFPA 70 and local codes. Hire a licensed electrician if you are unfamiliar with installing electrical wiring.
- Make sure the installation site you choose allows the fan blades to rotate without any obstructions. Allow a minimum clearance of 2.1m (7 feet) from the floor and 18 inches from the tip of the blades to the wall.
- The outlet box and support structure must be securely mounted and capable of reliably supporting a minimum of 35 pounds. Use only U.L. listed outlet boxes marked "Acceptable for Fan Support of 15.9 kg (35 lbs) or less".
- Before and after you install the fan, make sure that all mounting components are secured to prevent the fan from falling.
- Do not insert anything into the fan blades while the fan is operating.
- To change the direction of the rotation of the blades, the fan must be in operation mode.
- All screws must be checked and retightened where necessary before installation.
- After making the wire connections, the wires should be spread apart with the grounded conductor and the equipment-grounding conductor on one side of the outlet box and the ungrounded conductor on the other side of the outlet box.
- The splices after being made should be turned upward and pushed carefully up into the outlet box. Conductor wiring identified as grounded is to be connected to a grounded conductor of power supply. Conductor wiring identified as ungrounded conductor is to be connected to an ungrounded conductor. Conductor wiring identified for equipment grounding is to be connected to an equipment- grounding conductor.
- This device complies with part 15 of the FCC Rules. Operation is subject to the following two conditions: (1) This device may not cause harmful interference, and (2) this device must accept any interference received, including interference that may cause undesired operation.

# SAFETY PRECAUTIONS

---

- **CAUTION:** Read all instructions and safety information before installing your new fan. Review accompanying assembly diagrams.
- **WARNING:** Mount only to an outlet box marked acceptable for fan support.  
**AVERTISSEMENT:** Assembler uniquement à une boîte de sortie jugée acceptable pour retenir un ventilateur.
- **WARNING:** To reduce the risk of fire, electric shock, or personal injury, mount to a structural framing member or to an outlet box marked acceptable for fan support of 15.9 kg (35 lbs) or less. For outlet box mounting, use mounting screws provided with the outlet box.  
**AVERTISSEMENT:** Afin de réduire les risques d'incendie, de choc électrique ou de blessures corporelles, ils doivent être montés sur des éléments de charpente structurale ou sur des boîtes de sortie marquées d'un support de ventilateur acceptable de 15,9 kg (35 LB) ou moins. Pour l'installation de la boîte de sortie, utilisez les vis de montage fournies avec la boîte de sortie”
- **CAUTION:** To reduce the risk of injury, use only the screws provided with the outlet box in conjunction with the lock washers.
- **WARNING:** To reduce the risk of personal injury, do not bend the blade bracket when installing the brackets, balancing the blades, or cleaning the fan. Do not insert foreign objects in between rotating fan blades.
- **CAUTION:** To reduce the risk of electric shock, disconnect the electrical supply circuit to the fan before installing the light kit.
- **WARNING:** To reduce the risk of fire or electric shock, this fan must be installed with a general use, non-dimmable, single gang, isolating wall control/switch.
- **WARNING:** To reduce the risk of fire or electric shock, do not use this fan with any solid-state speed control device.  
**AVERTISSEMENT:** Ne convient pas à des régulateurs de vitesse à semi-conducteurs.
- **CAUTION:** The light source is designed for this specific application and can overheat if serviced by untrained personnel. If any servicing is required, the product should be returned to an authorized service facility for examination or repair.
- **WARNING:** Do not use corrosive detergents for cleaning.
- **WARNING:** To reduce the risk of fire, electric shock, or injury to persons, do not use replacement parts that have not been recommended by the manufacturer. (e.g. Parts made at home using a 3D printer).
- **NOTE:** Before installing the fan, please check and inspect all of the fan components and make sure they have all been received in good condition. Contact the manufacturer if there are any missing, damaged, or broken parts.

# Fan Diagram

---

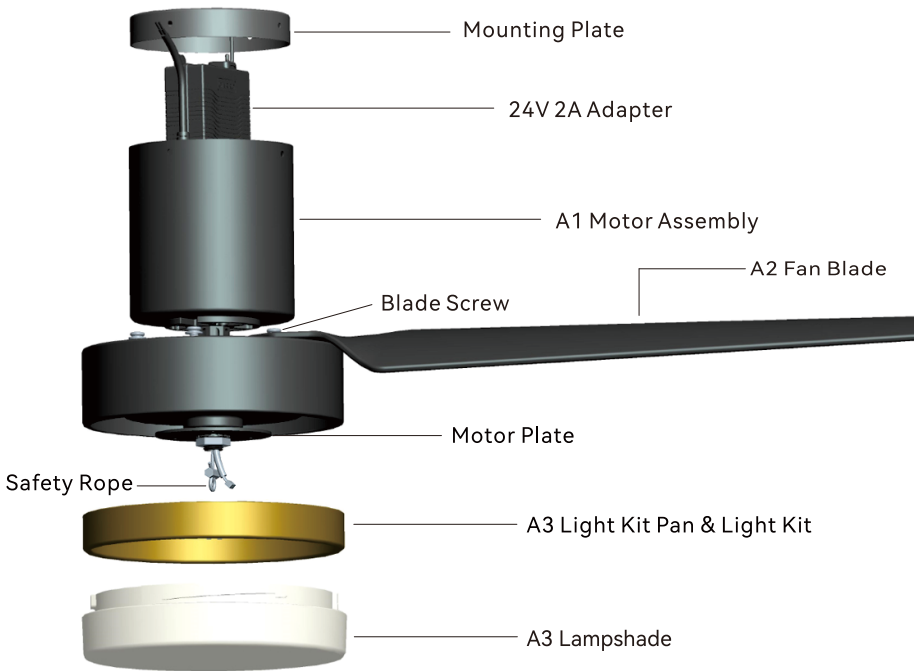

# Table of Contents

---

08	<b>Disassembly</b>
09	<b>Fan Blades</b>
10	<b>Fan Bucket</b>
12	<b>Light Kit Pan &amp; Light Kit</b>
14	<b>Mounting Options</b>
15	<b>Hanging</b>
16	<b>Safety Rope</b>
17	<b>Wiring</b>
18	<b>Securing the Fan</b>
19	<b>Lampshade / Power On</b>
20	<b>Remote Control</b>
21	<b>Home App</b>
22	<b>Smart Devices</b>
23	<b>Troubleshooting</b>
24	<b>Care &amp; Cleaning / FCC</b>

# Tools & Materials Required

---



Phillips  
screwdriver



Step  
ladder

## Package Contents

CARRO

Before installing, please check to make sure you have received all the necessary components for installation.

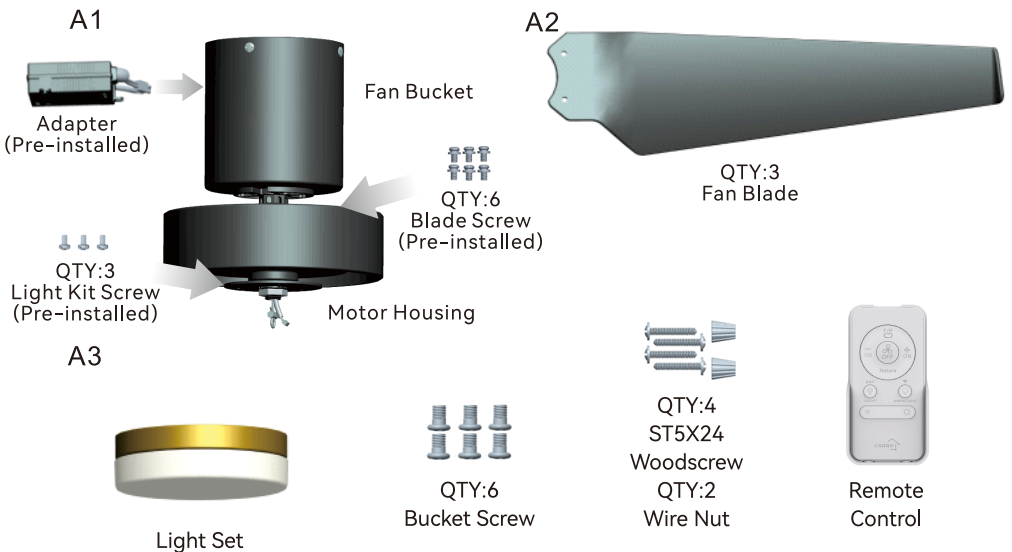

# Installation: Disassembly

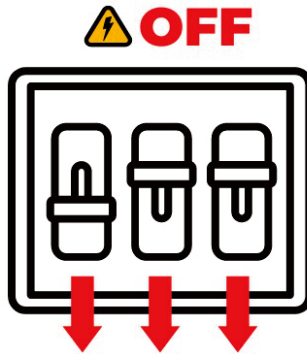

**WARNING:** To avoid serious injury or death, turn off the power at the circuit breaker before installing the fan.

## 1. Disassemble the Light Set

Remove the light set from its packaging and turn the lampshade counterclockwise to disassemble it, then subsequently detach the LED light kit from the light kit pan, as it is held in place by magnets.

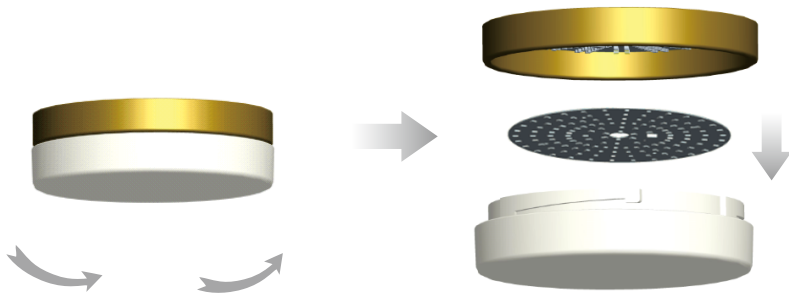

Fig. 1.1

Fig. 1.2

# Installation: Fan Blades

---

## 2. Install the Fan Blades

2.1 Remove 6 blade screws from the motor housing. Secure each blade to the motor hub using the screws as shown in Fig. 2.1.

2.2 Repeat steps for the remaining blades. Make sure all the screws are firmly tightened.

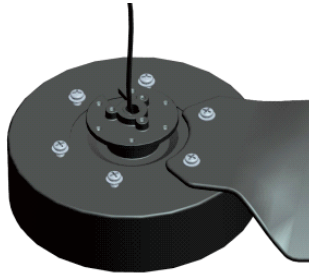

Fig. 2.1

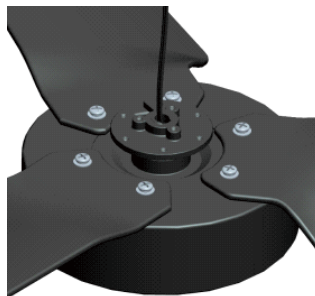

Fig. 2.2

# Installation: Fan Bucket

---

## 3. Install the Fan Bucket

3.1 Utilize a screwdriver to extract the two canopy screws situated in the single holes. Subsequently, gently loosen the other two canopy screws positioned in the L-shaped holes.

3.2 Proceed by rotating the mounting plate to align it with the designated notch, and then pull to detach the mounting plate. Remember to retain the screws for later use. Pull out the control box and adapter from the fan bucket.

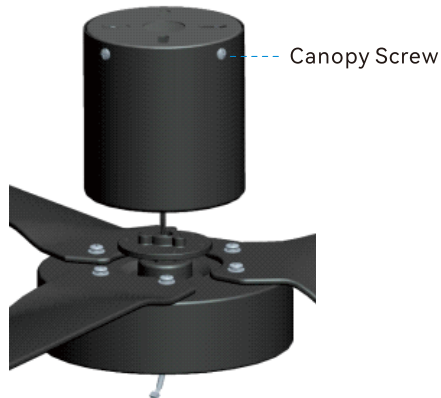

Fig. 3.1



Fig. 3.2

# Installation

---

3.3 Find the 6 bucket screws in the hardware pack and use them to secure the fan bucket to the motor housing. Ensure that all screws are tightened firmly.

3.4 Place the control box and adapter back into the fan bucket.

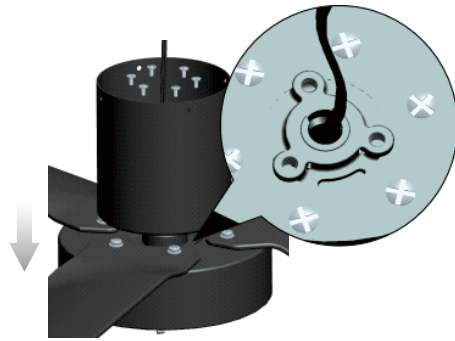

**Fig. 3.3**

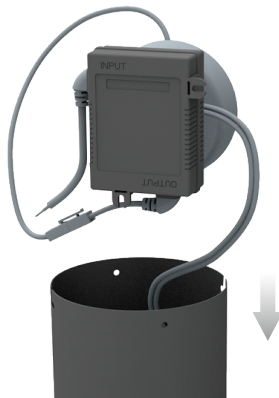

**Fig. 3.4**

# Installation: Light Kit Pan & Light Kit

---

## 4. Install the Light Kit Pan & Light Kit

4.1 Unscrew and remove one light kit assembly screw from the motor plate, then loosen the other two keyhole screws but do not fully remove. Keep the removed screw for later use.

4.2 Thread the wire plug from the motor and safety rope through the center hole of the light kit pan.

Attach the light kit pan to the motor plate, making sure the two screw heads fit through the keyhole slots. Twist the light kit pan until the screws slide into the narrow ends of the keyhole slots.

Securely tighten all screws, and then reinstall the light kit assembly screw that was previously removed. Ensure that all screws are securely tightened.

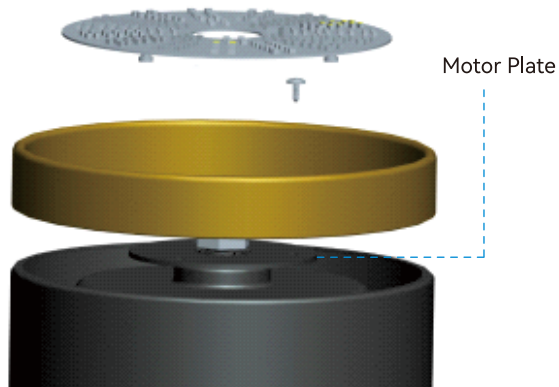

Fig. 4.1

# Installation

---

4.3 Allow the safety rope and wire plug to pass through the light kit. Reinstall the light kit. The light kit will be magnetically attracted to the pan with the help of magnets. Insert the wire plug into the light kit terminal block.

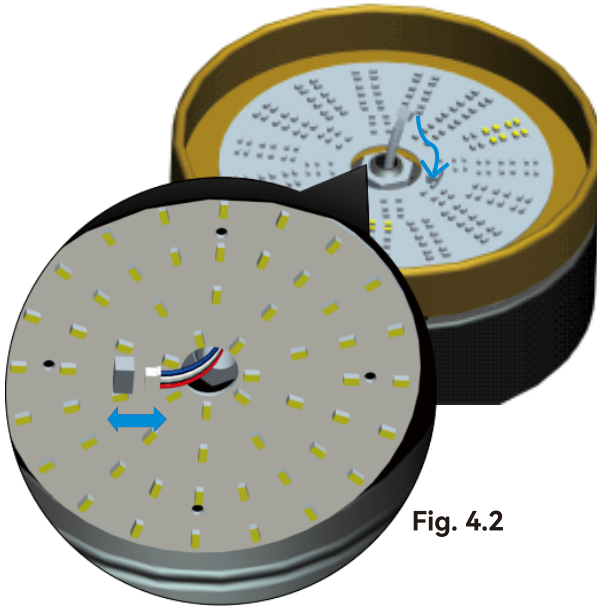

Fig. 4.2

# Installation: Mounting Options

---

## 5. Install the Mounting Plate

You have two options for the mounting plate installation. Choose the one that works best for your location.

**WARNING:** Before beginning, make sure to turn off the power from the circuit breaker!

**Note:** For optimal fan performance, ensure that the mounting plate is level.

**Option 1:** Secure the mounting plate to a wooden ceiling beam or support structure with an approved electrical outlet box using the ST5x24mm wood screws (included) as shown in Fig. 5.1.

**Option 2:** Use machine screws (provided with outlet box) and washers to attach the mounting plate to an existing ceiling fan-rated outlet box. If the mounting plate is installed at the outlet box, it should be installed on the outlet box with the screws that came with your outlet box. Pull the supply wires (the black, white, and ground wires) out of the outlet box and through the hole in the mounting plate, then set them aside.

**WARNING:** DO NOT use a plastic outlet box. Use only U.L. listed outlet boxes marked "Acceptable for Fan Support of 15.9 kg (35 lbs) or less".

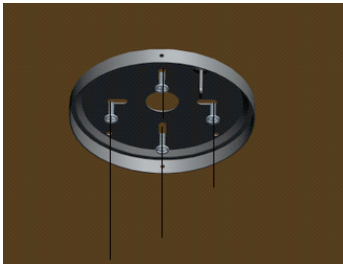

Fig. 5.1



Fig. 5.2

# Installation: Hanging

---

## 6. Hang the Fan

6.1 Carefully lift the fan-motor assembly and hang it using the hook of the mounting plate. Securely suspend the motor assembly by using one of the round holes at the outer rim of the motor housing as shown in Fig. 6.1.

**WARNING:** Hazard of Fan Falling! Ensure the circular hole on the outer edge of the motor housing is fully engaged with the hook on the mounting plate to securely hang the fan motor assembly.

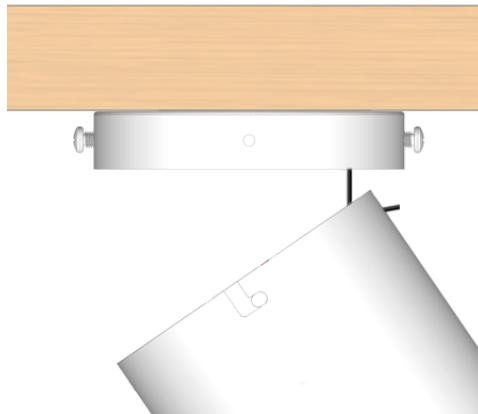

**Fig. 6.1**

# Installation: Safety Rope

---

6.2 There are multiple methods to install the safety rope; here are two options for your reference.

**Option 1:** Refer to Fig. 6.2. Hang the safety rope on the ceiling hook (not included). Using a screwdriver, loosen the screw on the safety rope lock. Pull the safety rope taut and then tighten the screw on the safety rope lock to ensure a firm and secure connection between the safety rope and the ceiling hook. Always double-check to ensure the safety rope is taut.

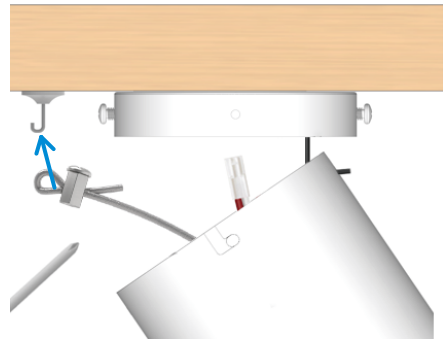

Fig. 6.2

**Option 2:** Refer to Fig. 6.3. Thread a screw, accompanied by a washer (both not included), through the center of the safety rope. Fasten the screw to the ceiling and then loosen the screw on the safety rope lock using a screwdriver. Pull the safety rope taut and then tighten the screw on the safety rope lock to securely anchor the safety rope to the fixed screw on the ceiling. Always double-check to ensure the safety rope is taut.

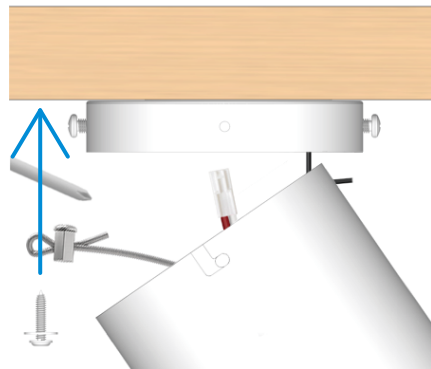

Fig. 6.3

**Note:** Installing the ceiling fan with a safety rope is an extra safety feature. It secures the fan to the ceiling hook or other attachment point and prevents the fan from falling even in the case of material failure.

When the safety rope is fixed and installed, it is important to adjust both the length of the wire rope and the screw on the safety rope lock to ensure a secure and tight connection with the fixed object. This step is crucial to prevent the safety rope from accidentally coming off. Improper installation of the safety rope may compromise its effectiveness and lead to potential safety risks. Therefore, it is essential to make sure the safety rope is properly tightened and secured for maximum safety.

# Installation: Wiring

---

## 7. Connect the Wiring

Connect the wire plug of the motor to the wire plug of the adapter and confirm the connection is secure.

Connect the Green/Yellow wire from the mounting plate to the supply Ground wire using a wire nut.

Connect the White wire of the adapter to the supply White (Neutral) wire using a wire nut. Connect the Black wire of the adapter to the supply Black/Red (Hot/Live) wire using a wire nut.

Make sure all the wires are connected to the correct colors as shown in Fig. 7.1. Then, hide the wiring and the adapter inside the motor housing.

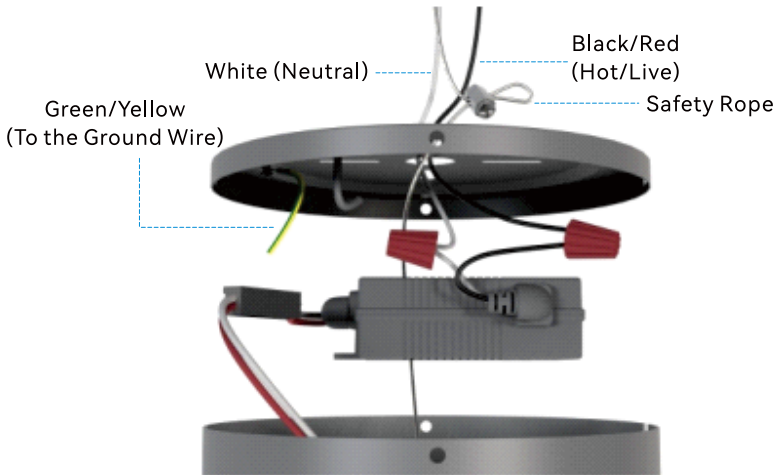

Fig. 7.1

# Installation: Securing the Fan

---

## 8. Secure the Fan

With both hands, gently lift the fan body off of the hook. Ensure that the hook does not interfere with the adapter.

Align the L-shaped holes on both sides of the fan body with the two loosened canopy screws on the mounting plate. Slide the two slots on both sides of the fan body between the heads of the screws, and then rotate the fan body to ensure the screws hold the fan body firmly in place.

Reinstall the other two canopy screws that were previously removed into the single holes. Tighten all four screws securely.

**WARNING:** Falling fan hazard! Make sure all screws are tightened securely to hold the fan motor assembly in place.

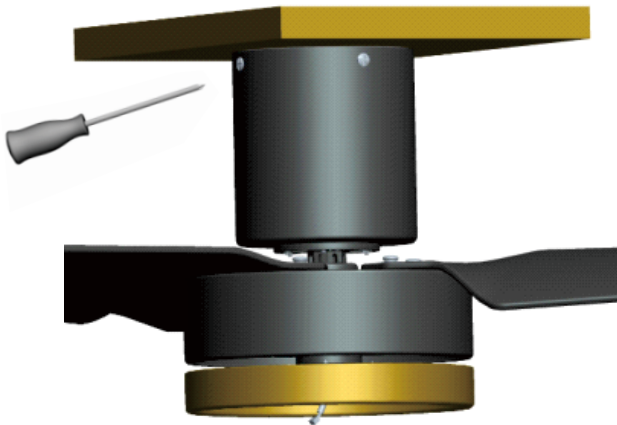

Fig. 8.1

# Installation: Lampshade / Power On

---

## 9. Install the Lampshade

Align the slots of the lampshade with the slots of the light kit, and turn the lampshade clockwise to securely lock it into place, as shown in Fig. 9.1.

**Note:** Do not over tighten the lampshade.

**WARNING:** To prevent SERIOUS INJURY or DEATH, make sure that the lampshade is properly secured. Allow the lampshade to cool completely before attempting to remove it.

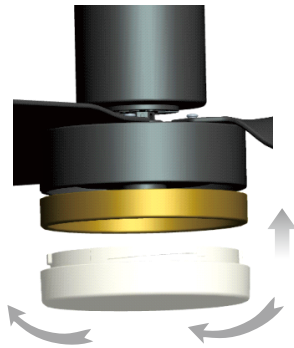

Fig. 9.1

## 10. Power On

At this time, the ceiling fan has been installed. Turn on the power supply from the circuit breaker of the main switch or the room where the ceiling fan is installed. Once the power is on, check to see if the fan light is illuminated and pair the fan with the remote immediately.

**Note:** Please be aware that this ceiling fan may produce noticeable operating sounds at specific wind speeds. This is a normal operating characteristic and does not indicate any issues with its functionality.



# Remote Control Instructions

## Pair the Remote Control to Your Fan

Power on the fan and pair the remote to the fan within 1 min. To pair remote to fan, press and hold  button for 5-10 secs to pair. Successful pairing will trigger the fan light off.

**Note:** If you do not pair the fan to the remote within 1 minute of connecting it to the power, you will need to reset the fan by disconnecting it from the power before attempting to pair the remote again.

## Remote Control Button Definitions



Turn the fan off.



Switch between summer mode and winter mode.

· Summer mode - (Counter-clockwise)

· Winter mode - (Clockwise)

**Note:** Fan must be running to switch between Summer / Winter modes.



Turn the fan on and decrease fan speed.



Turn the fan on and increase fan speed.

**Nature** Toggle the fan speed between "Nature Mode" and "Breeze Mode". Simulate a soothing breeze that is gentle enough not to disrupt your sleep. To revert to the fan's regular mode, simply press either the speed-up or speed-down button.



Turn the light on or off and remote pairing.

**Note:** Power on the fan and pair the remote to the fan within 1 min. To pair remote to fan, press and hold  button for 5-10 secs to pair. Successful pairing will trigger the fan light off.



Switch between warm light and cool light. WIFI Pairing.

**Note:** Press/hold button for 5 sec. The fan will switch to AP Mode, then select AP Mode on APP, follow the APP control instructions and enable fan Wi-Fi.



Press/Hold button to decrease the light intensity.



Press/Hold button to increase the light intensity.

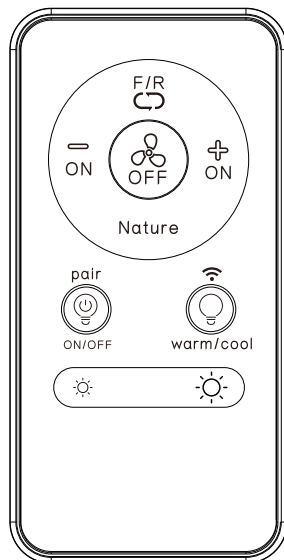

**WARNING:** Do not expose the remote control to direct contact with water.

# Connecting to the App

---

1. First download the free App from the App Store or Google Play.

**Note:** This ceiling fan needs to use 2.4Ghz WIFI to work when connecting the device, and after connecting, it can use the 5Ghz or 2.4Ghz.

2. Open the App to create your account. The account can be registered through E-mail only.
3. Connect the device to the App (Three ways to connect) :

## ①Bluetooth Connect (WIFI & Bluetooth On)

- a. Press "+" button into the device list, then a window will pop up to show you some devices can be connected.
- b. Click "Go to add" (If you click "Do not add" by mistake, please see "Do not add" steps).
- c. Choose the device.
- d. Connect to your home WIFI, then go back to the app and wait for the app to connect with your device.

"Do not add" steps:

- a. Select "Lighting" on the sidebar menu then select "Smart Ceiling Fan" and tap next.
- b. Connect to your home WIFI and tap "Next" to wait for the connection.

**Note:** if your device does not appear in the "go to connect" section, continuously hold the WIFI Pairing button until the hotspot pops up as a discoverable device.

## ②WIFI Connect-AP Mode (WIFI On & Bluetooth Off)

- a. Smart ceiling fan: Press and hold the WIFI button on the remote for 5 seconds for AP Mode. Smart switch: Press and hold the "OFF" button for 10 seconds till the indicator light blinks slowly to enter into AP Mode.
- b. Press "+" button to select "Lighting" on the sidebar menu then select "Smart Ceiling Fan".
- c. Connect to your home WIFI (2.4Ghz Only).
- d. Press "Next" button to go to connect the fan's WIFI signal.
- e. Choose the fan's WIFI signal "XXXX" then go back to the app.
- f. Wait for the connection.

## ③WIFI Connect-EZ Mode (WIFI On & Bluetooth Off)

- a. Press "+" button to select "Lighting" on the sidebar menu then select "Smart Ceiling Fan".
- b. Connect to your home WIFI (2.4Ghz Only) and next.
- c. Click the right corner on the top to choose "EZ Mode".
- d. Tap "Next" button to wait for the connection to complete.

# Connecting to Smart Devices

---

1. Connect the device to Google Home:

- a. Make sure you have connected the device to the App and it is working normally.
- b. Open the Google Home app, select set up a device, and choose "Works with Google".
- c. Search for , log in with your App account and password, then authorize and connect with the App.
- d. Then the Google Assistant will find the device automatically.

2. Connect the device to Siri shortcuts:

Make sure you have connected the device to the App and it is working normally.

- a. Tap "Scene" on the main menu.
- b. Tap "Create Scene".
- c. Tap "Launch Tap To Run".
- d. Tap "+".
- e. Run the device.
- f. Choose the device you want to control by Siri.
- g. Select the function you want to control by Siri.
- h. Then save the function setting.
- i. To add to Siri, choose the scene you have created, and then select add to Siri.
- j. Enter the sentence you want to say to initialize the device, and add to Siri.

# Troubleshooting

Try these troubleshooting steps before contacting Customer Service. For additional operation, maintenance, and troubleshooting information, please contact our customer service center.

SYMPTOM	POSSIBLE SOLUTION
Fan not spinning	<p>① Make sure the fan is getting power. ② Check your circuit breaker or fuse panel and wall switch for functionality. ③ Check to make sure the fan wires are correctly connected to the house wires. ④ Remote control must be paired with the fan within 1 minute after connecting the fan to the electricity. ⑤ If you have paired the app but the fan still does not work (light and fan both didn't work) or couldn't pair the app to the fan, try to reset the fan: to reset the fan, cut the power for 10 minutes, then turn the power on and press the pairing button  on the remote for 5-10 seconds until the fan light turns off, then pair the App again. ⑥ Use a multi-meter and test the wiring harness to see if there is any electrical output. ⑦ All the pin wiring on the circuit board must be inserted tight and in the correct position. ⑧ Remote needs to be paired with the fan first. ⑨ Make sure the fan blades spin freely. ⑩ If you're using a wall control, check the power to the breaker from your control and try working your ceiling fan manually. (Normal switch is only used for connecting the fan to the house electricity.)</p>
Fan light not working	<p>① Make sure LED wires are connected to the circuit board. ② Make sure the whole fan is powered.</p>
The fan is noisy and wobbling	<p>① Check if the blade screws are NOT rubbing against any part of the motor housing. ② Check if the pin wires are NOT touching against any moving parts. ③ Check if the bottom wire cover is NOT hitting the motor. ④ Confirm the canopy is NOT touching the ceiling while the fan is in operation. ⑤ Check the down rod is NOT slanted. ⑥ Tighten any loose screws on the light kit, fan blades, motor coupling, down rod, brackets and mounting hardware. ⑦ Confirm the hanger ball is firmly seated in the mounting bracket. ⑧ The ceiling beam must meet the minimum tensile test strength of 30kg for installation. ⑨ Make sure the blades and brackets are NOT bent or deformed. ⑩ Verify the wire connections are not rattling against each other. ⑪ Verify the fan blades are not cracked. If the fan blades are cracked, replace the damaged blades with a new blade set from the same brand as your ceiling fan to ensure compatibility. ⑫ Confirm the light kit is NOT slanting and hitting the motor.</p>
Unable to pair remote and app	<p>① Check if the wires are connected in the correct position or not. ② Check the batteries in the remote. ③ Disconnect the power for 10 minutes, reconnect the power and pair the remote with the fan immediately, within 1 minute. Also try pairing the app to reconnect. ④ The WiFi must be 2.4Ghz, incompatible with 5Ghz WiFi or combined with 5Ghz. This ceiling fan needs to use 2.4Ghz WIFI to work when connecting the device, and after connecting, it can use the 5Ghz or 2.4Ghz. ⑤ App must be the newest version. ⑥ Connect with correct app.</p>
Fan or light turning on or off by themselves	<p>① Confirm the circuit breaker is not malfunctioning. ② Verify the wire connections are not frayed. ③ Check the app is not set to a timer or schedule. ④ Cut the fan power for 10 minutes then power on again. ⑤ All the pin wiring on the circuit board must be inserted tight and in the correct position.</p>

# Care & Cleaning

---

**WARNING:** Power off the fan before performing maintenance or cleaning the fan.

1. Check the support connections, brackets, and blade attachments twice a year. Make sure they are secure. Because of the fan's natural movement, some connections may become loose over time. It is not necessary to remove the fan from the ceiling.
2. Clean your fan periodically. Use only a soft brush or lint-free cloth to avoid scratching the finish. The plating is sealed with a lacquer to minimize discoloration or tarnishing.
3. (Optional) Apply a light coat of furniture polish to the wood blades.
4. (Optional) Cover small scratches with a light application of shoe polish.

**DO NOT:**

1. Use water when cleaning. Water could damage the motor, or the wood, or possibly cause an electrical shock.
2. Apply oil to your fan or motor. The motor has permanently lubricated sealed ball bearings.

## FCC Statement

---

**Note:** This equipment has been tested and found to comply with the limits for a Class B digital device, pursuant to part 15 of the FCC Rules. These limits are designed to provide reasonable protection against harmful interference in a residential installation. This equipment generates, uses and can radiate radio frequency energy and, if not installed and used in accordance with the instructions, may cause harmful interference to radio communications. However, there is no guarantee that interference will not occur in a particular installation. If this equipment does cause harmful interference to radio or television reception, which can be determined by turning the equipment off and on, the user is encouraged to try to correct the interference by one or more of the following measures:

- Reorient or relocate the receiving antenna.
- Increase the separation between the equipment and receiver.
- Connect the equipment into an outlet on a circuit different from that to which the receiver is connected.
- Consult the dealer or an experienced radio/TV technician for help.

**WARNING:** Changes or modifications to this unit not expressly approved by the party responsible for compliance could void the user's authority to operate the equipment.