

ASSEMBLY INSTRUCTION

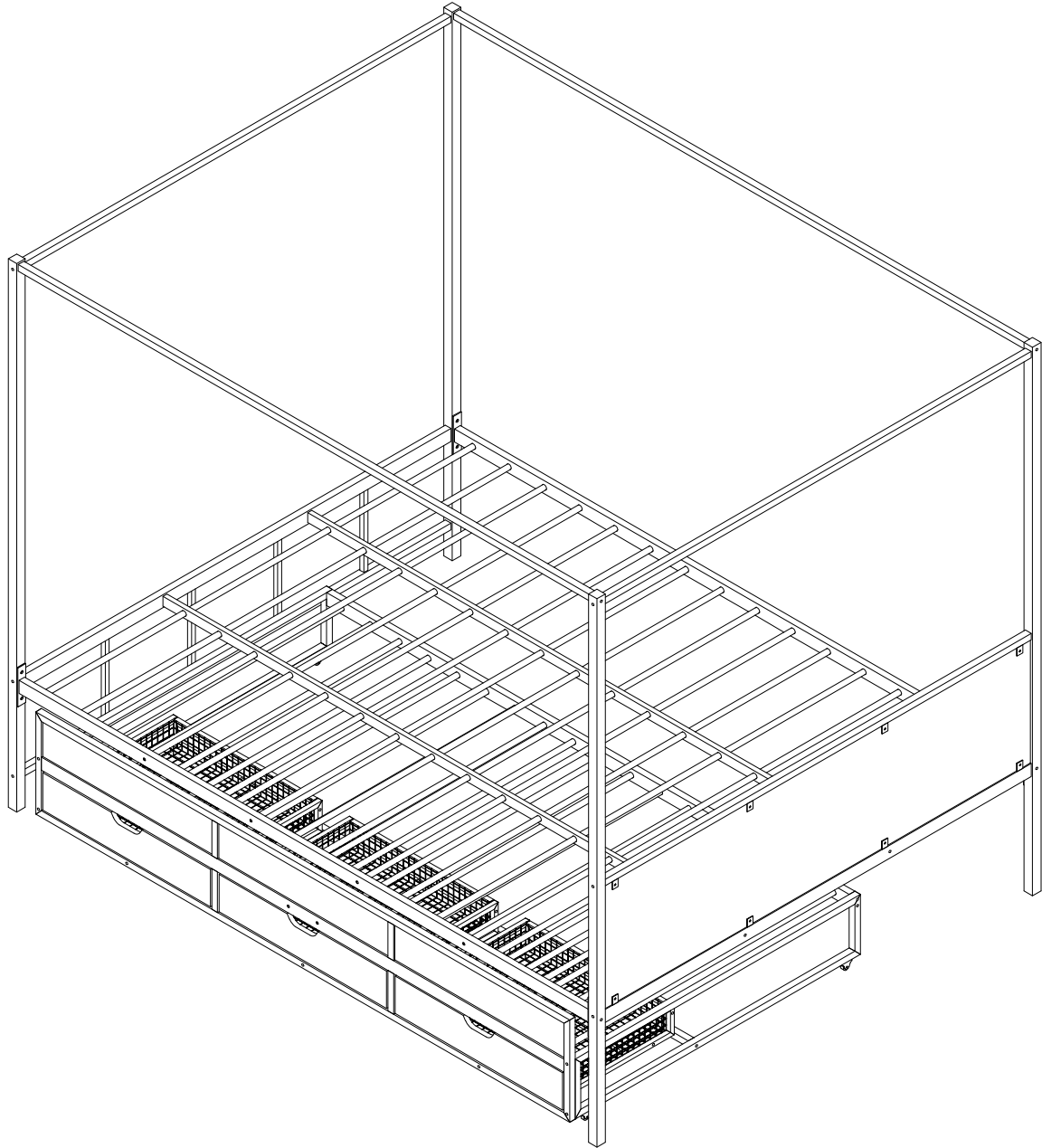

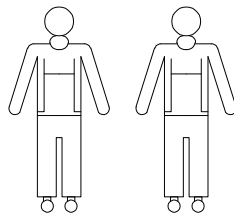

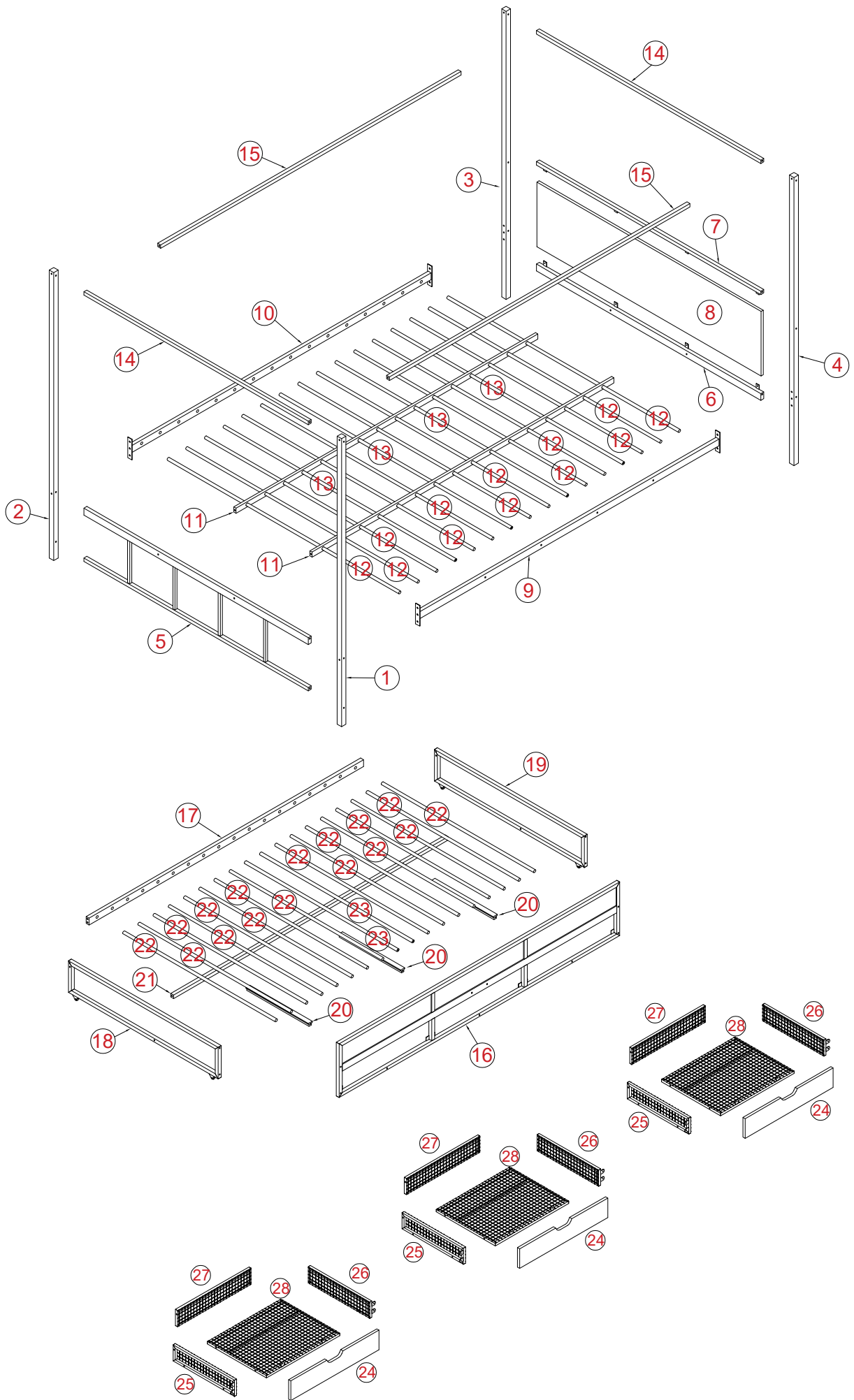



Minimum no. 2 of people
recommended to assemble
this product: Approx.
assembly time: 60 mins

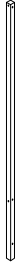
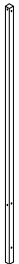

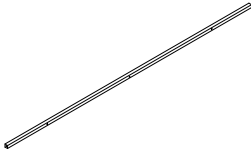
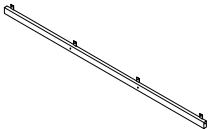
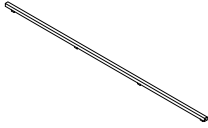
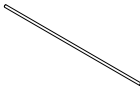
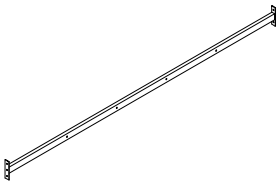
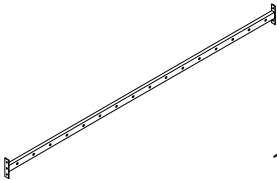

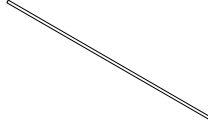
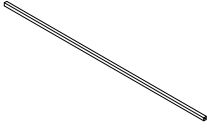
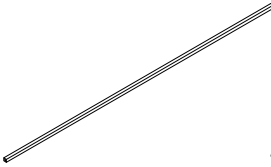
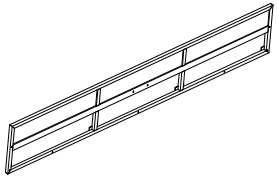
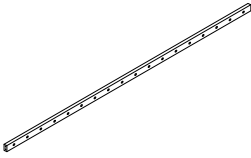





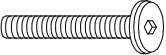
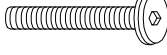
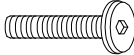





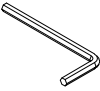

PART LIST

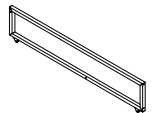
1		2		3	
	1PC		1PC		1PC
4		21		6	
	1PC		1PC		1PC
7		22		9	
	1PC		16PCS		1PC
10		23		25	
	1PC		2PCS		1PC
13		14		15	
	4PCS		2PCS		2PCS
16		17		26	
	1PC		1PC		1PC
27					
	2PCS				

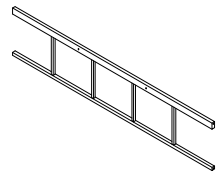
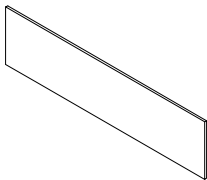
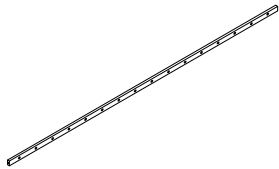
HARDWARE LIST

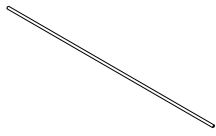
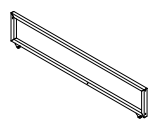

A		B		C		D		E	
	20 PCS M $\frac{1}{4}$ "X50		20 PCS M $\frac{1}{4}$ "X35		24 PCS M $\frac{1}{4}$ "X25		20 PCS M $\frac{1}{4}$ "X15		8 PCS #30x30x16
F		G		H		i		J	
	4PCS 15x20x40H		26PCS M4x15		6PCS 8x28x60		26PCS M3.5x15		1PC M4X23X57

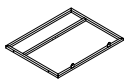
PART LIST

<p>19</p>  <p>1PC</p>	<p>20</p>  <p>3PCS</p>	<p>5</p>  <p>1PC</p>
<p>8</p>  <p>1PC</p>	<p>11</p>  <p>2PCS</p>	<p>24</p>  <p>3PCS</p>
<p>12</p>  <p>12PCS</p>	<p>18</p>  <p>1PC</p>	<p>27</p>  <p>1PC</p>
<p>25</p>  <p>2PCS</p>	<p>26</p>  <p>2PCS</p>	<p>28</p>  <p>3PCS</p>

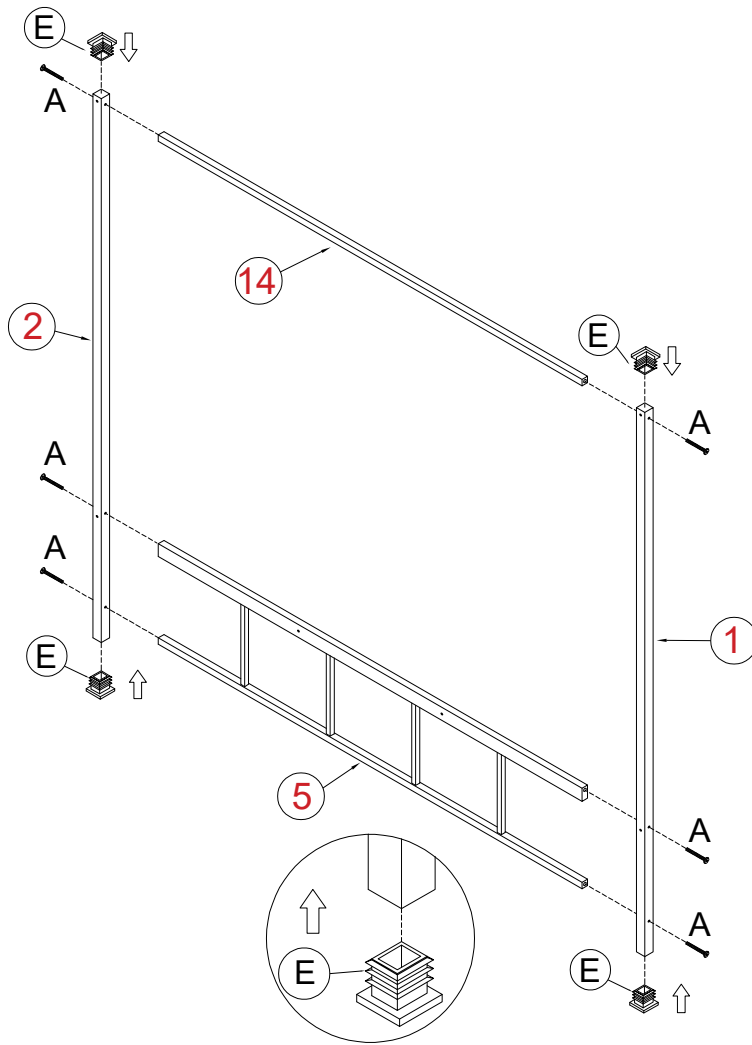
STEP 1





A	E
 M $\frac{1}{4}$ "x50	 #30x30x16
6 PCS	4PCS

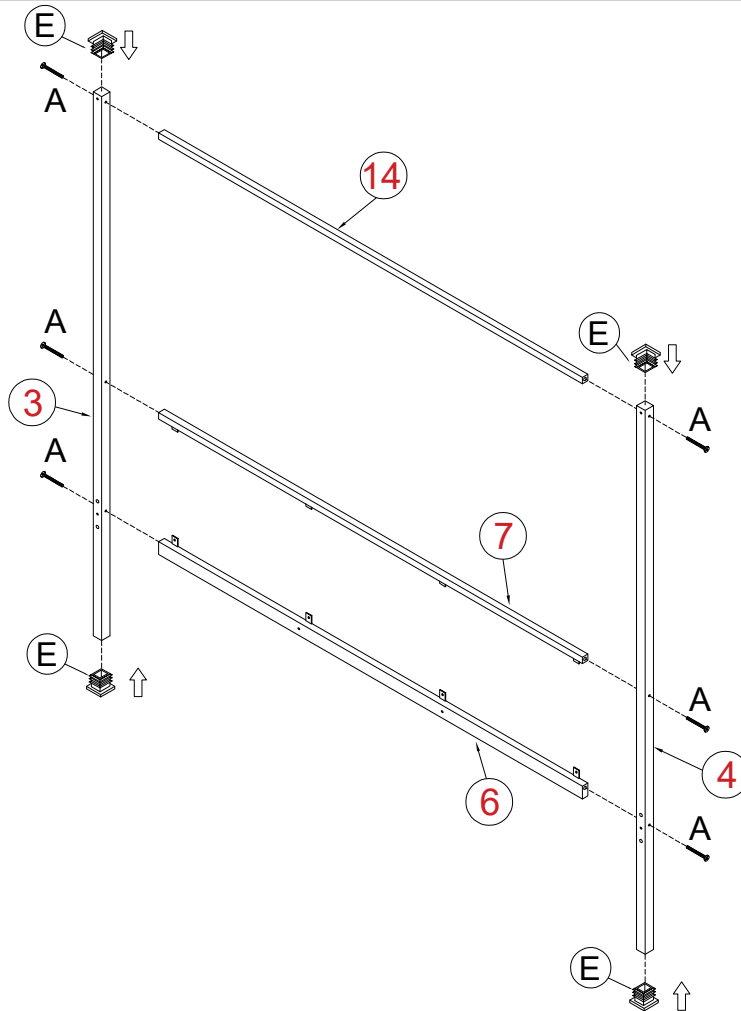

STEP 2



A	E
 M $\frac{1}{4}$ "x50	 #30x30x16
6 PCS	4PCS



STEP 3

i
 M3.5x15
8 PCS

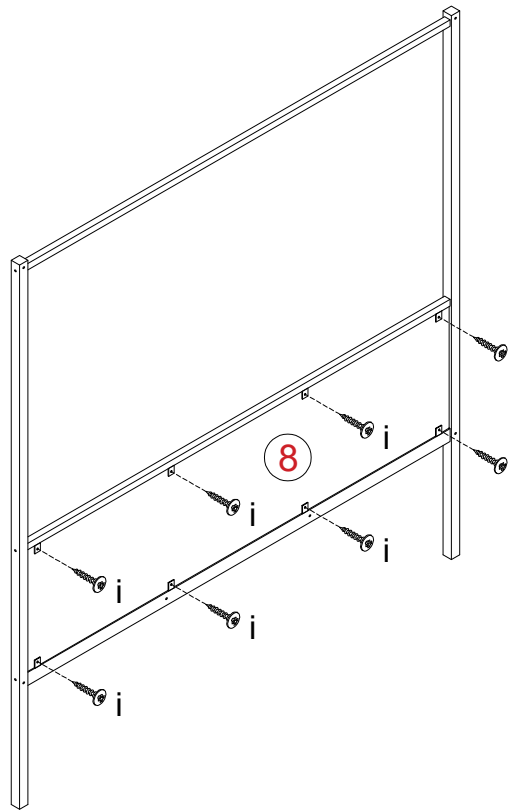

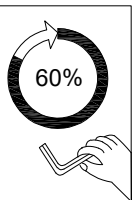
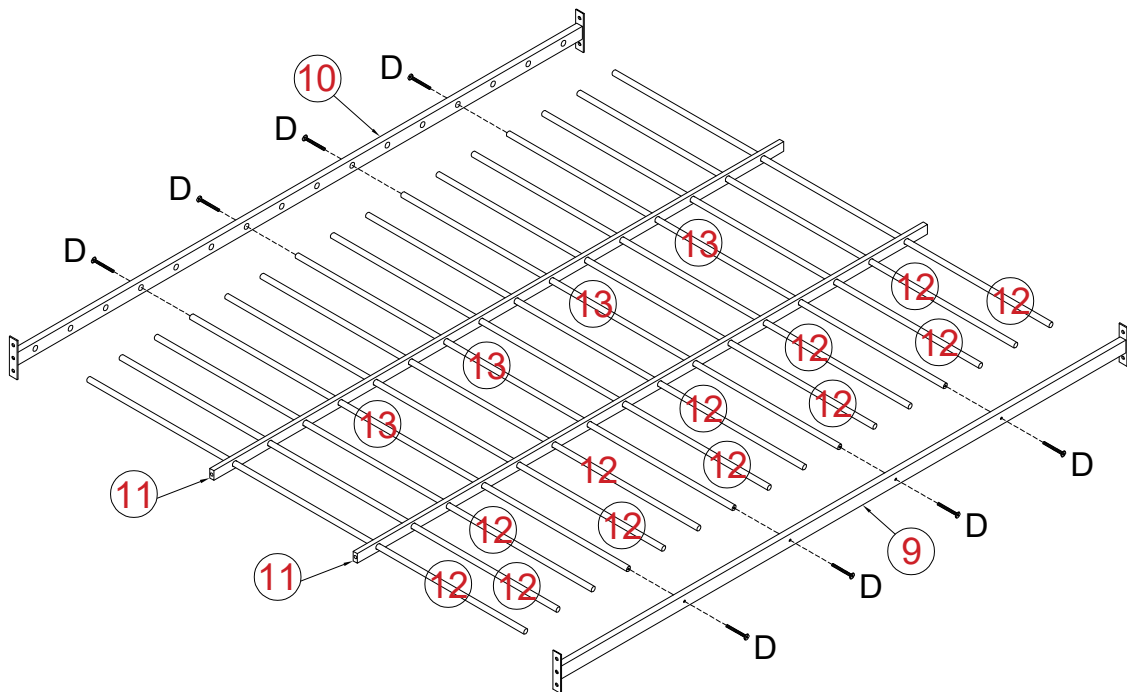

STEP 4

D
 M $\frac{1}{4}$ x15
8 PCS



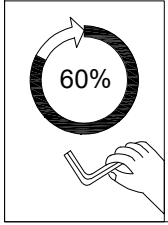
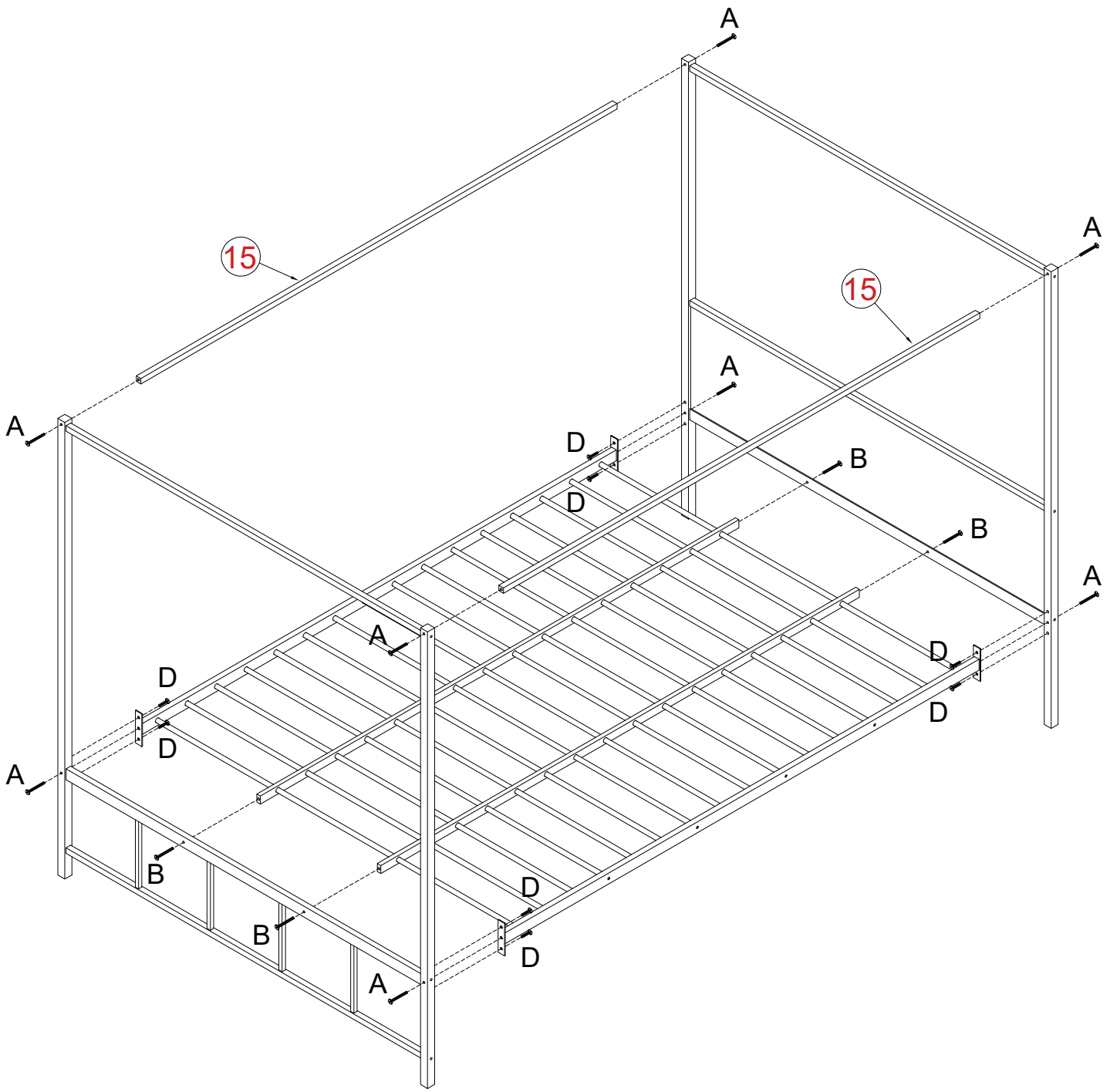

STEP 5

A	B	D
 M $\frac{1}{4}$ "x50	 M $\frac{1}{4}$ "x35	 M $\frac{1}{4}$ "x15
8 PCS	4 PCS	8 PCS



STEP 6

F	G
 15x20x40H	 M4x15
4 PCS	8 PCS

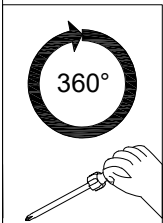
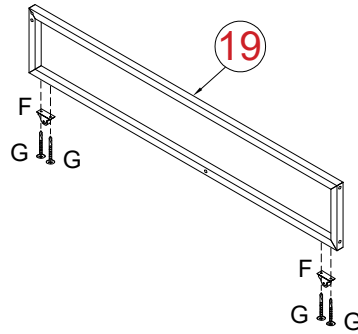
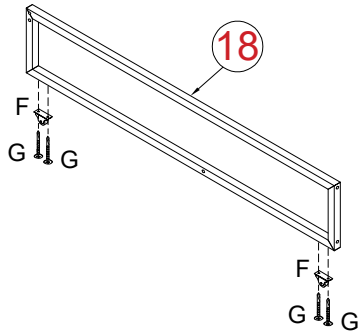

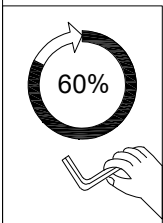
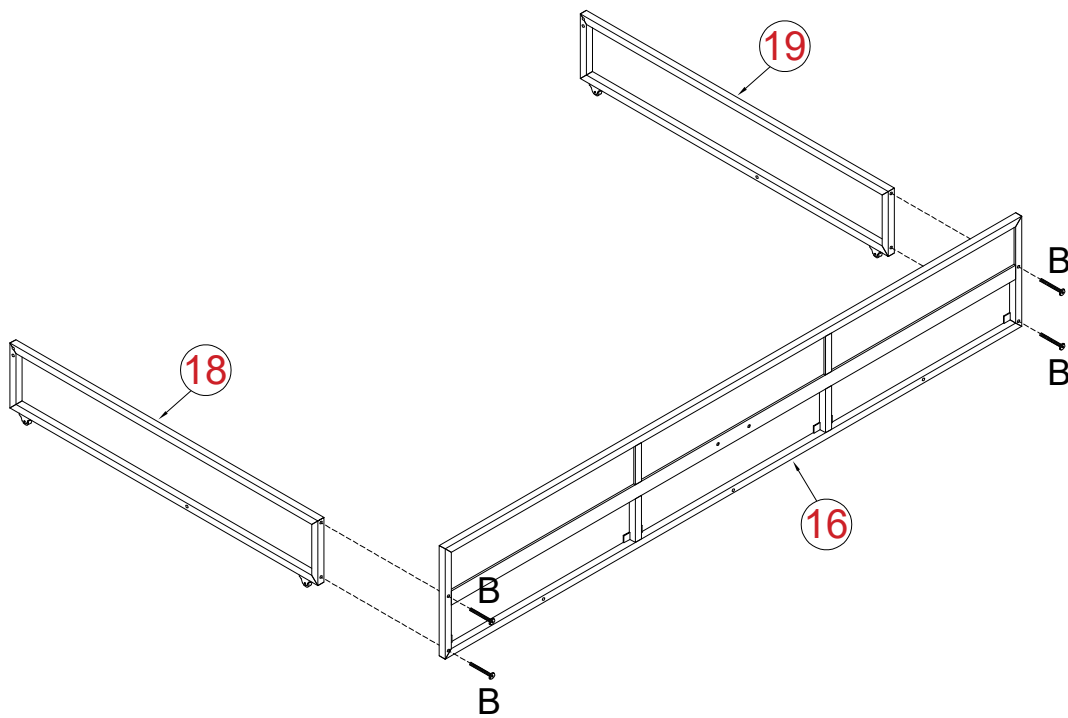

STEP 7

B
 M $\frac{1}{4}$ "x35
4 PCS



STEP 8

B	D
 M $\frac{1}{4}$ "x35	 M $\frac{1}{4}$ "x15
4 PCS	4 PCS

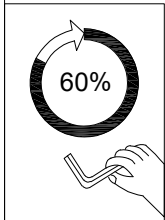
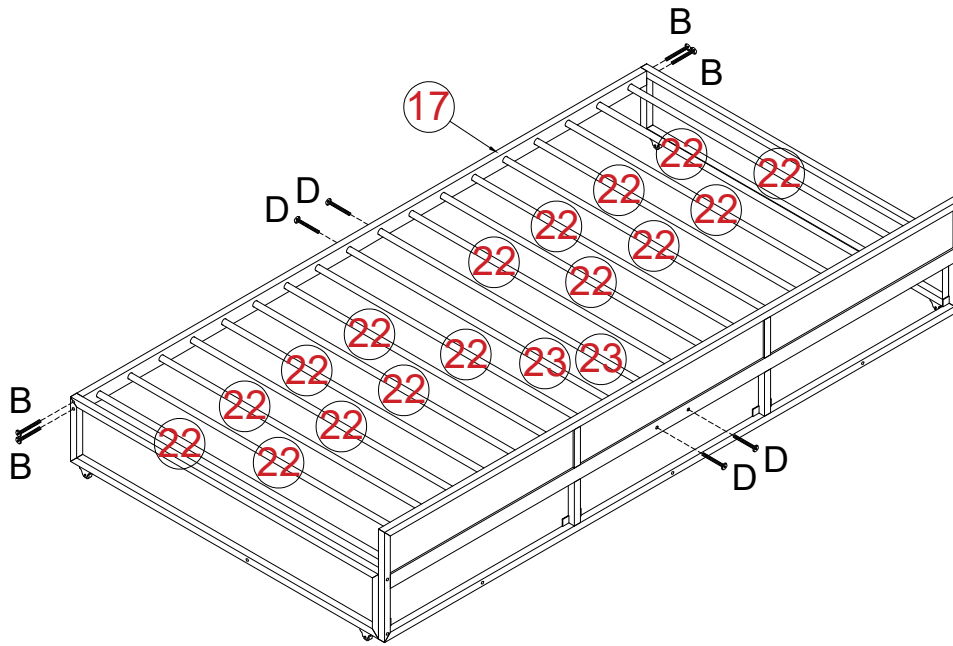

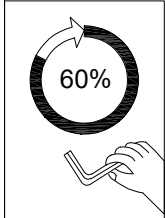
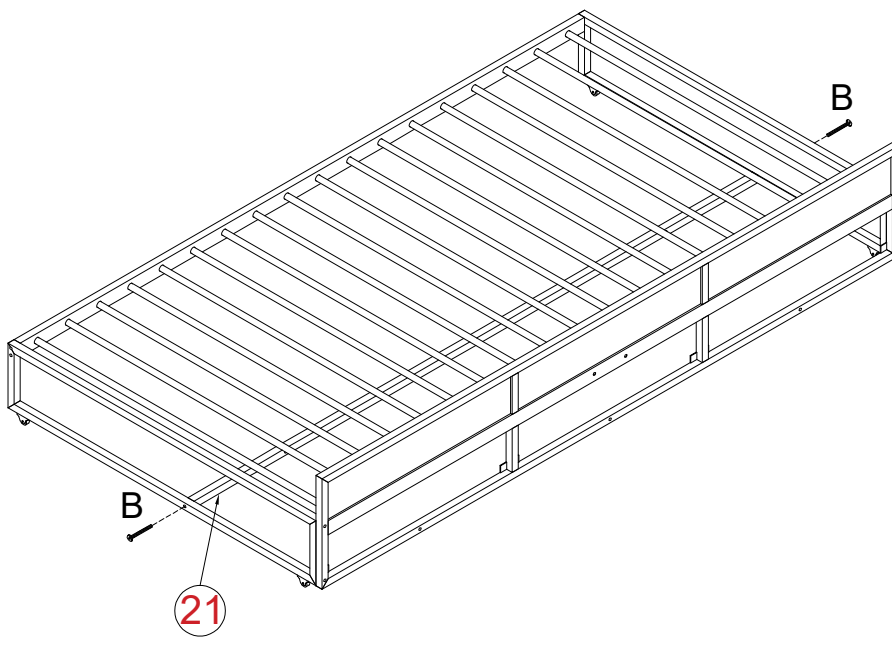

STEP 9

B
 M $\frac{1}{4}$ "x35
2 PCS



STEP 10

H	G
	
8x28x60	M4x15
6 PCS	18 PCS

3 SET

3 SET

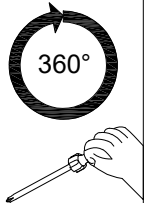
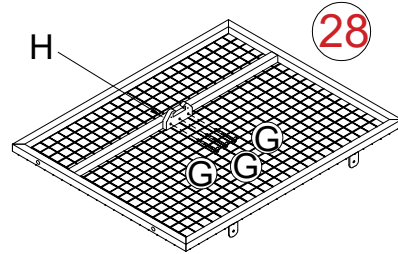
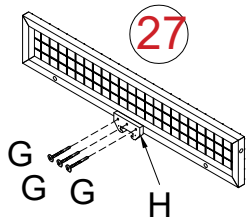

STEP 11

3 SET

C

M $\frac{1}{4}$ x25

6 PCS

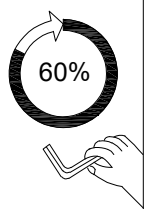
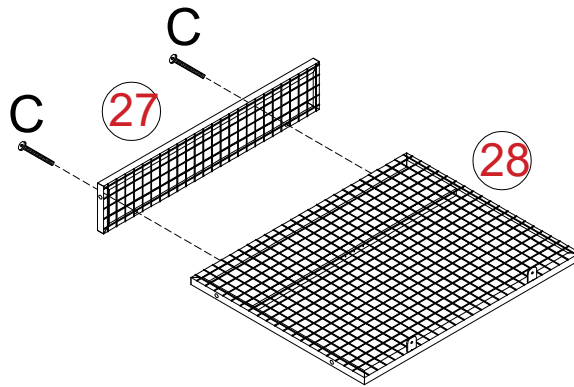

STEP 12

3 SET

C

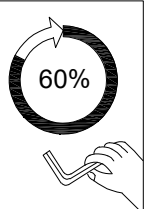
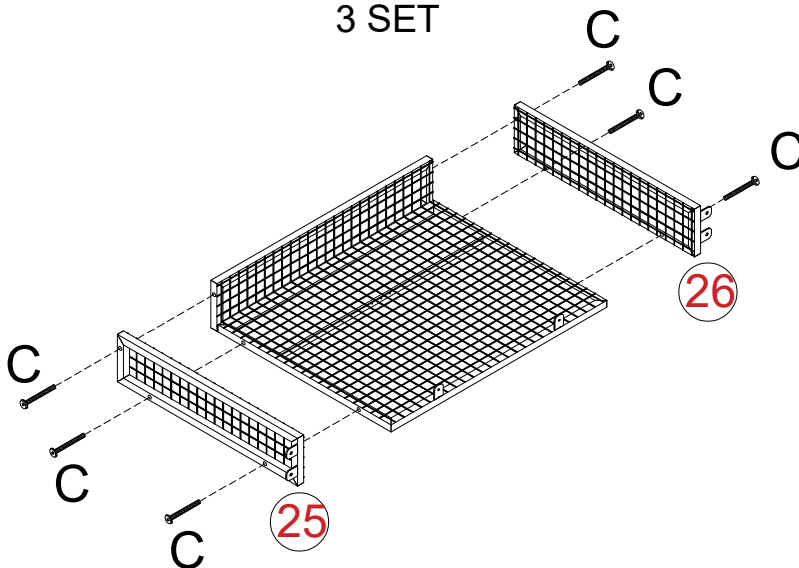

M $\frac{1}{4}$ x25

18 PCS



STEP 13

3 SET

i
 M3.5x15
18PCS

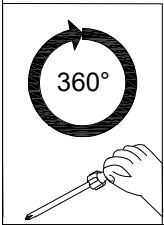
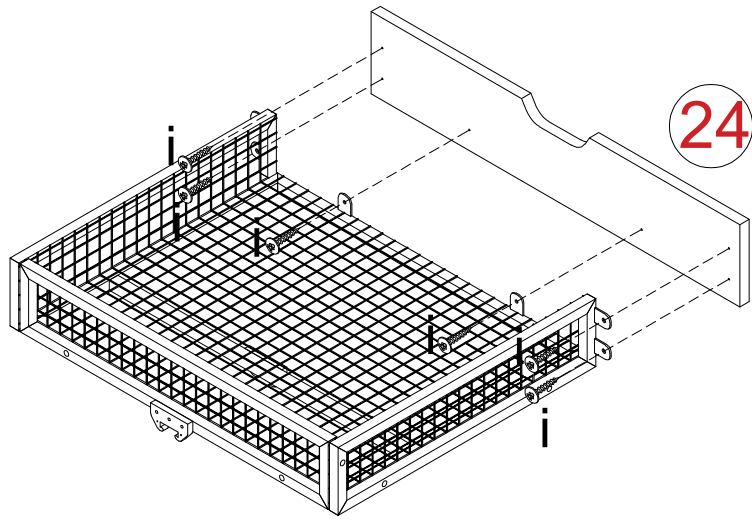

STEP 14

3 SET

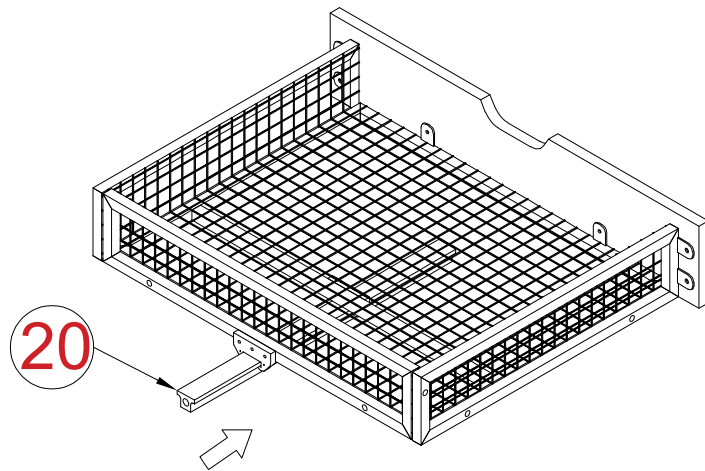

STEP 15

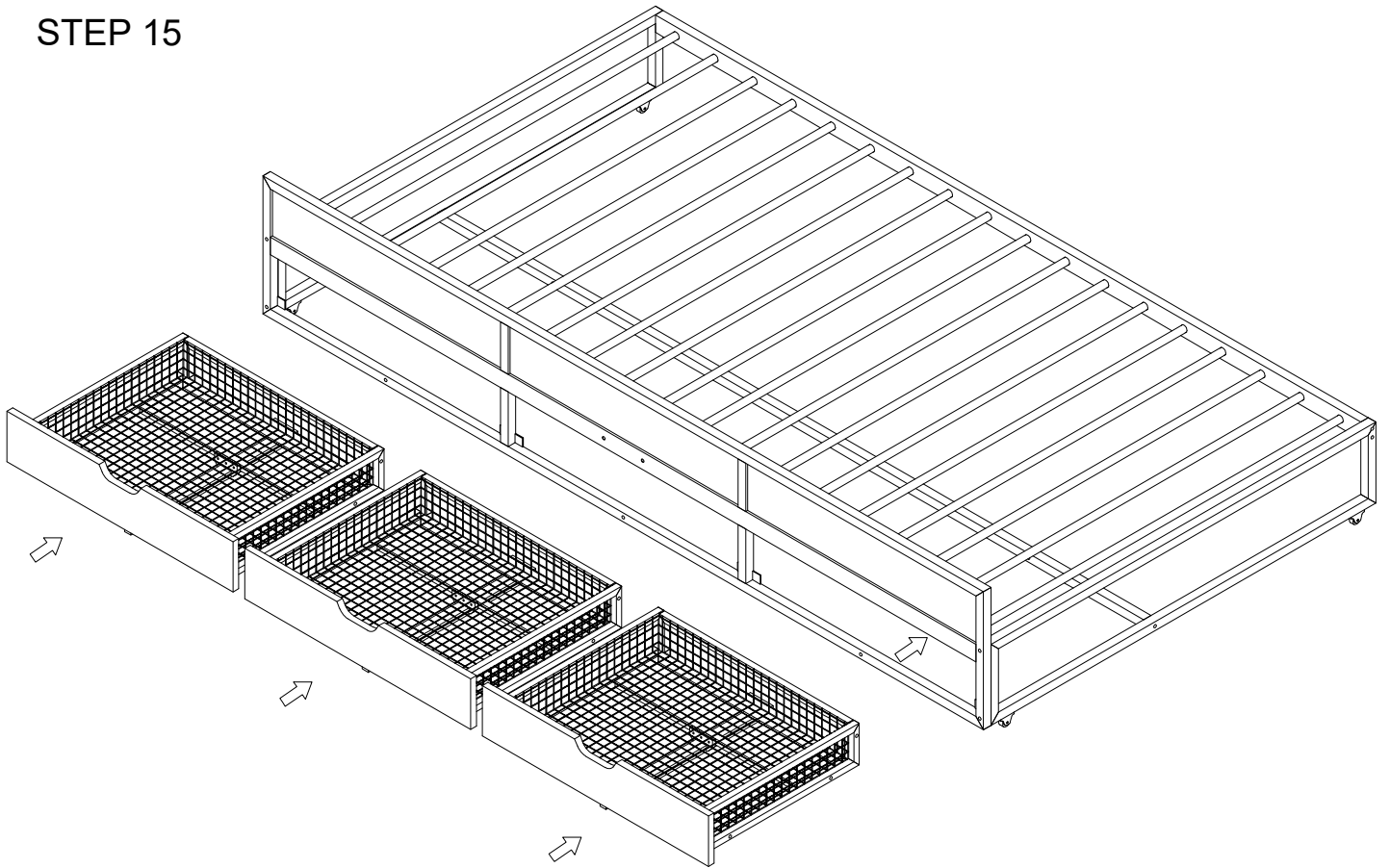

STEP 16

B
 M $\frac{1}{4}$ "x35
6 PCS

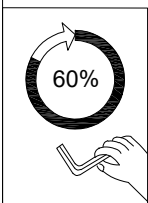
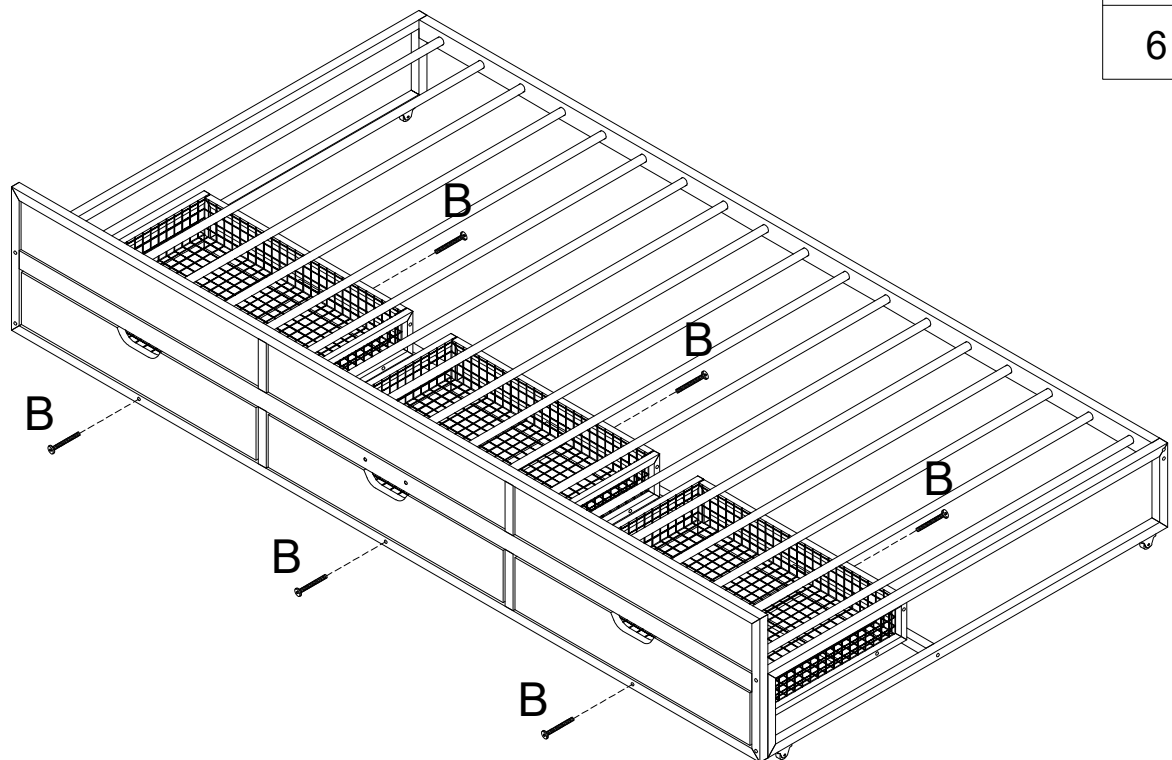

STEP 17

