

NOTICE

* Please make sure that you have all parts indicated and they are in good condition before you begin assembly of this item. Refer to part list and hardware list below for guidance.

* This item should be assembled on a soft surface to prevent scratching the finish during assembly.

* This item may require periodic tightening.

* If you are having difficulty, our friendly Customer Care team is always here to help.

PREPARATION

* Before beginning assembly of product, make sure all parts are present. Compare parts with part contents list and hardware contents list.

* If any part is missing or damaged, do not attempt to assemble the product

* Estimated assembly time : **20 minutes.**







* Tools required for assembly (included) : **Allen key**

* Tools required for assembly (not included) : **Phillip screw driver**

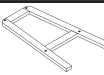
CARE AND MAINTENANCE

Always use felt pads under all articles to prevent discoloration or softening of the lacquer. Plastic and rubber bases on items can discolor wood. Wipe up spill immediately and avoid common hazards such as hot dishes, harsh solvents and abrasives. Cleaning should be done with a soft lint free cotton cloth dampened with water or furniture polish.

Part List and Hardware List

PIECE	DESCRIPTION	PICTURE	QUANTITY
A	Box Frame		1x
B	Leg Frame		2x
HW 1	Jcbc Bolt M6x0.5x80mm		8x
HW 2	Barrel Nut		8x
HW 3	Plastic Washer		8x
HW 4	Allen Key		1x
HW 5	Silver Metal Knob		2x
HW 6	Truss screw		2x

Product Dimensions : 26.77" W x 15.74" D x 23.62" H

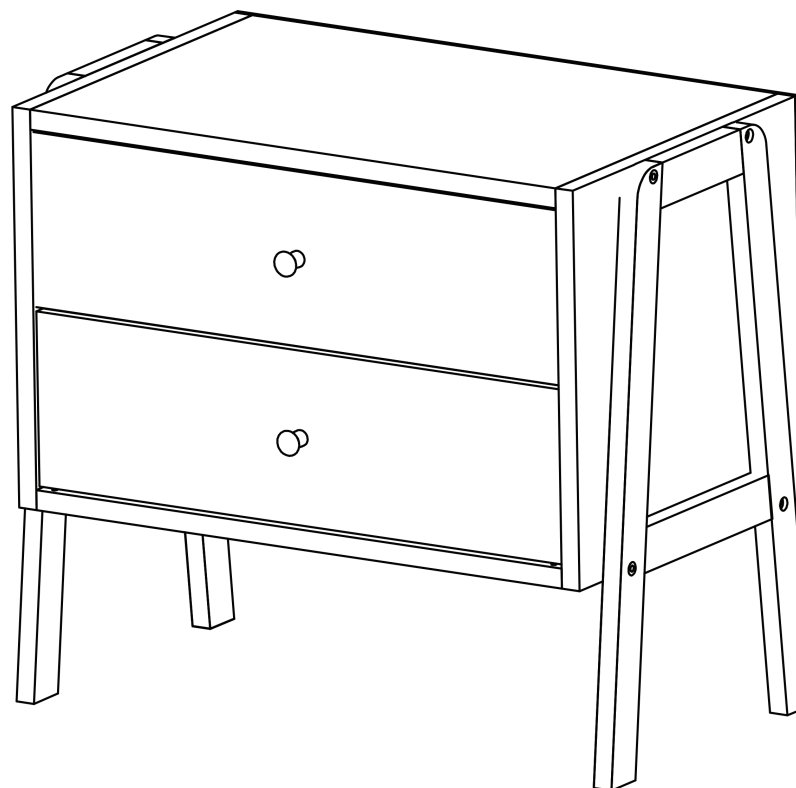

Weight capacity - 92 LBS

Warning : Do not stand on night stand.

Warning : Do not over torque bolts.

PREPARATION

- * Before beginning assembly of product, make sure all parts are present. Compare parts with part contents list and hardware contents list.
- * If any part is missing or damaged, do not attempt to assemble the product.
- * Estimated assembly time : 20 minutes
- * Tools required for assembly (included) : Allen key
- * Tools required for assembly (not included) : Philip screw driver
- * If you are having difficulty, our friendly Customer Care team is always here to help.

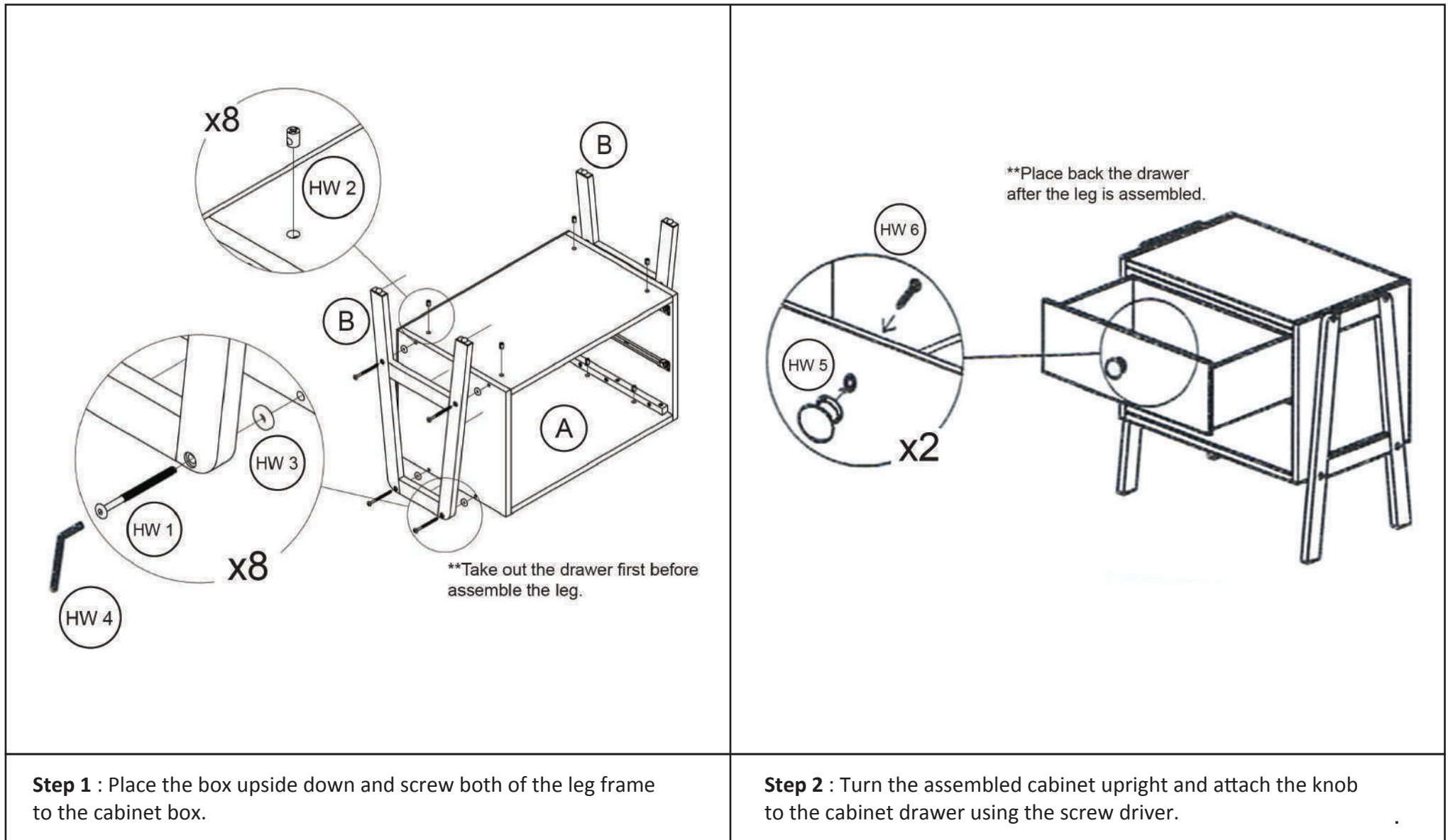

Step 1 : Place the box upside down and screw both of the leg frame to the cabinet box.

Step 2 : Turn the assembled cabinet upright and attach the knob to the cabinet drawer using the screw driver.