

Rocker Swivel Recliner

Assemble Manual

Note: This chair will come with 2 separate boxes, we ship them on the same day but the carrier may deliver them to your door on different days, please kindly wait for more 1-3 business days if you only receive one box.

Please make sure you get 1 x Box(A) and 1 x Box(B) before assembly.



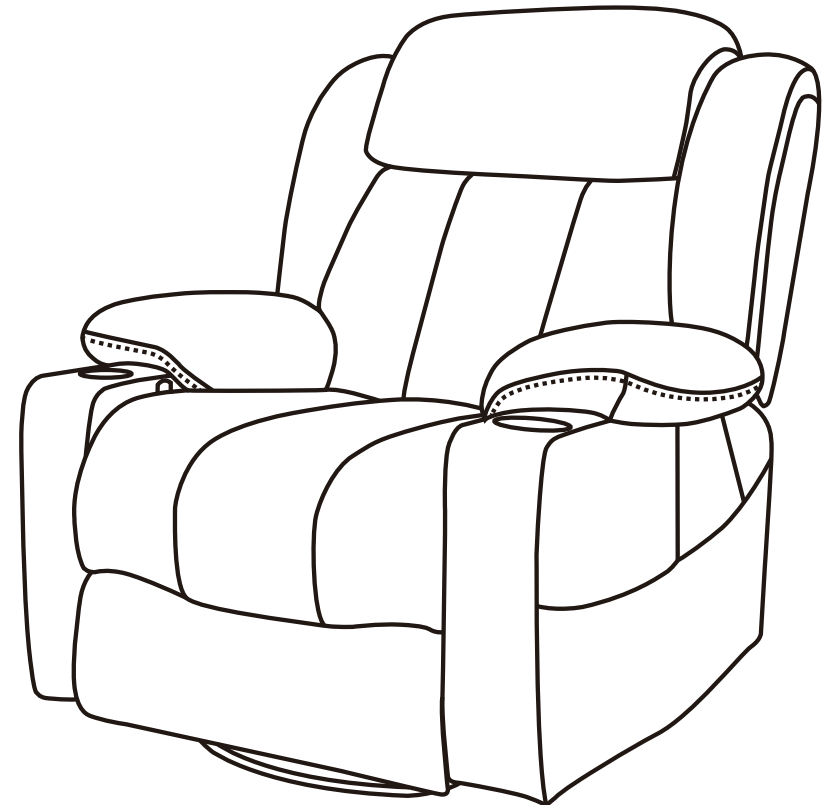

Box(A) : Chair Base*1, Right Armrest*1

Box(B) : Backrest*1, Left Armrest*1, Accessories Box, Assembly Manual

For any query, please feel free to contact us with your order number, we'll offer you an ideal resolution within 24 hours.

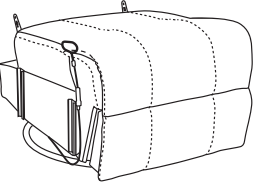
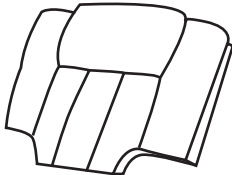
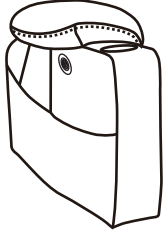

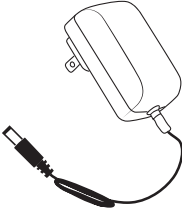
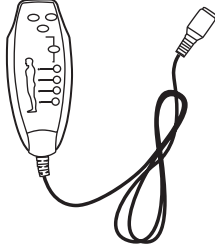
Rocker Recliner Assembly Instruction-CH008XZ

A 	B 	C 	D 	E 	F 	G 
Chair Base	Chair Back	Left Armrest	Right Armrest	Power Cord	Massage Remote	2 IN 1 Line

STEP 1

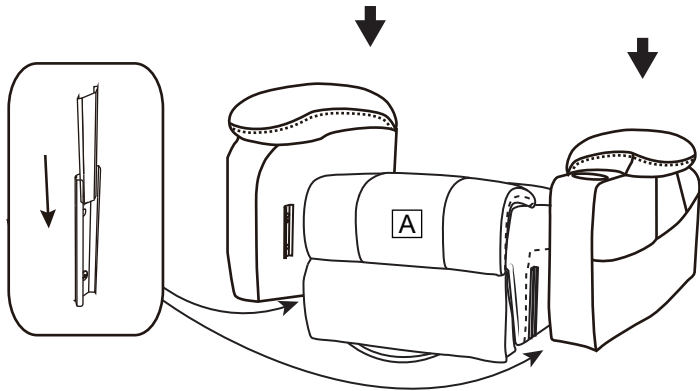

Insert Left Armrest(C)&Right Armrest(D) to the chair base, make sure the slots on the armrests fully assembled to the bottom part.

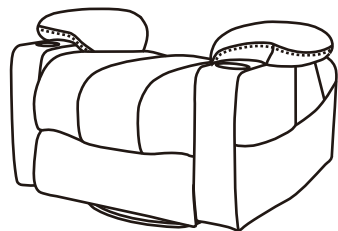

STEP 2

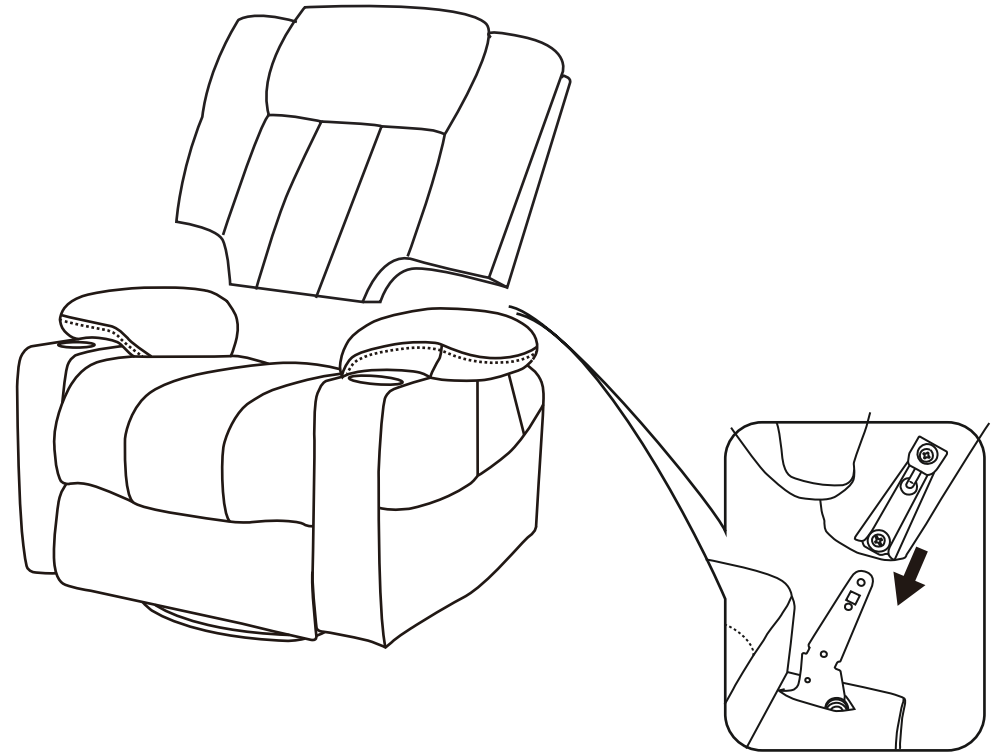

Insert Chair Back(B)to the Chair Base(A), make sure the slots on the back fully assembled to the bottom part.

Rocker Recliner Assembly Instruction

STEP 3

NOTE:

Wire 1: RED wire from the backrest connect to the RED wire from the base.

Wire 2: WHITE wire from the backrest connect to the WHITE wire from the base.

Wire 3: BLACK smaller wire from the backrest connect to the 2 IN 1 Line(G).

Wire 4: BLACK bigger wire from the backrest connect to the Massage Remote(F).

Wire 5: The other end of this 2 IN 1 line connect to the wire from the right armrest.

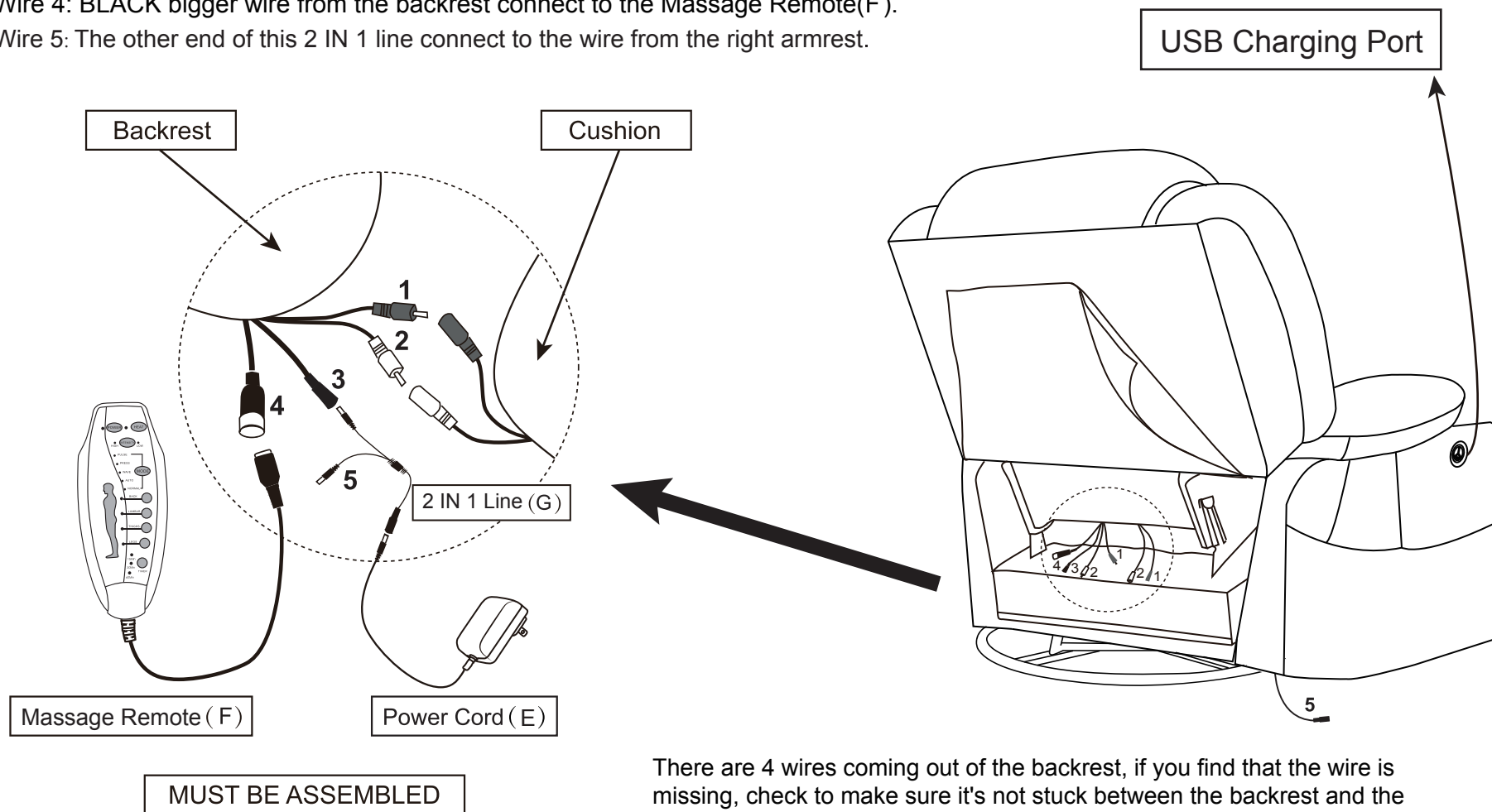

Rocker Recline Assembly Instruction

How to recline?

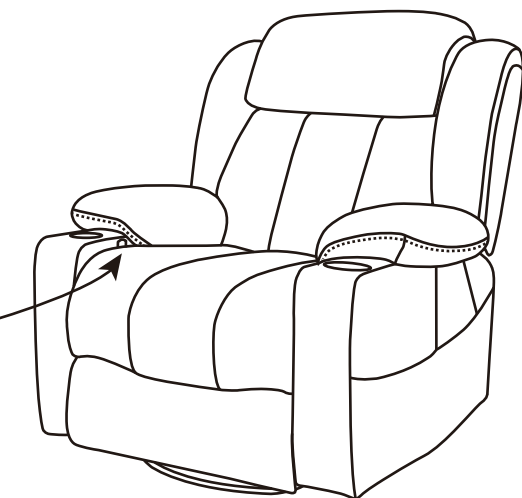
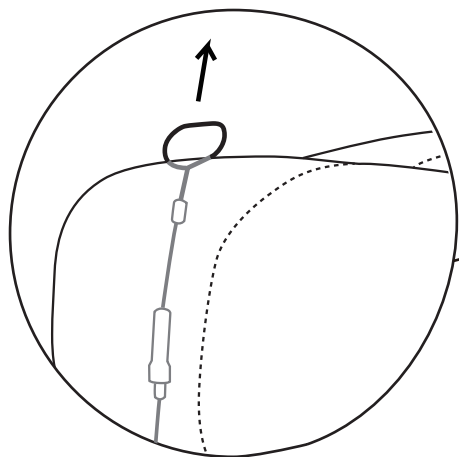

1. Lift the handle up to release footrest

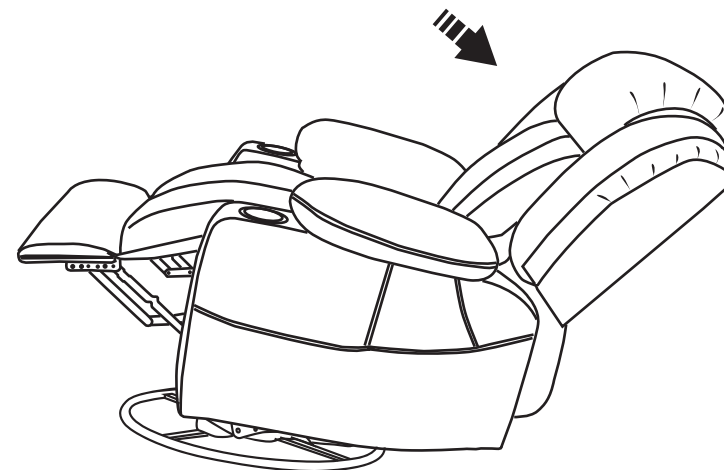

2. Sit deeper on the chair, put hands on armrests, lie down and use both head and back strength to recliner, then you have a relax on chair.

How to get footrest latch down?

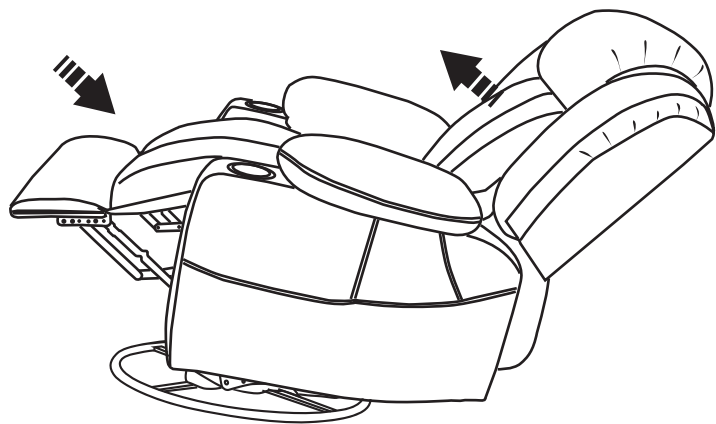

1. Sit on the chair (not recline), backrest will be back.

Note: footrest will not close in reclined position.

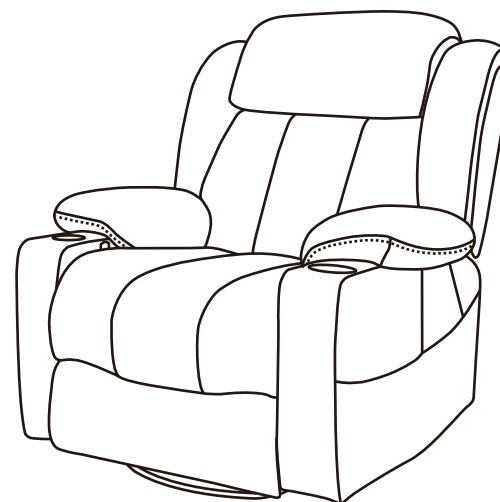

2. Press the bottom of footrest with some strength (with feet), try some times to get footrest latch down. Then the chair will be in seated position.

Rocker Recliner Assembly Instruction

How to disassemble the chair?

Please note that you need to take apart the backrest from base before removing the arms

1. Pull up the buckles firstly while take the backrest out from the base.
2. Then pull out the arms from the base.

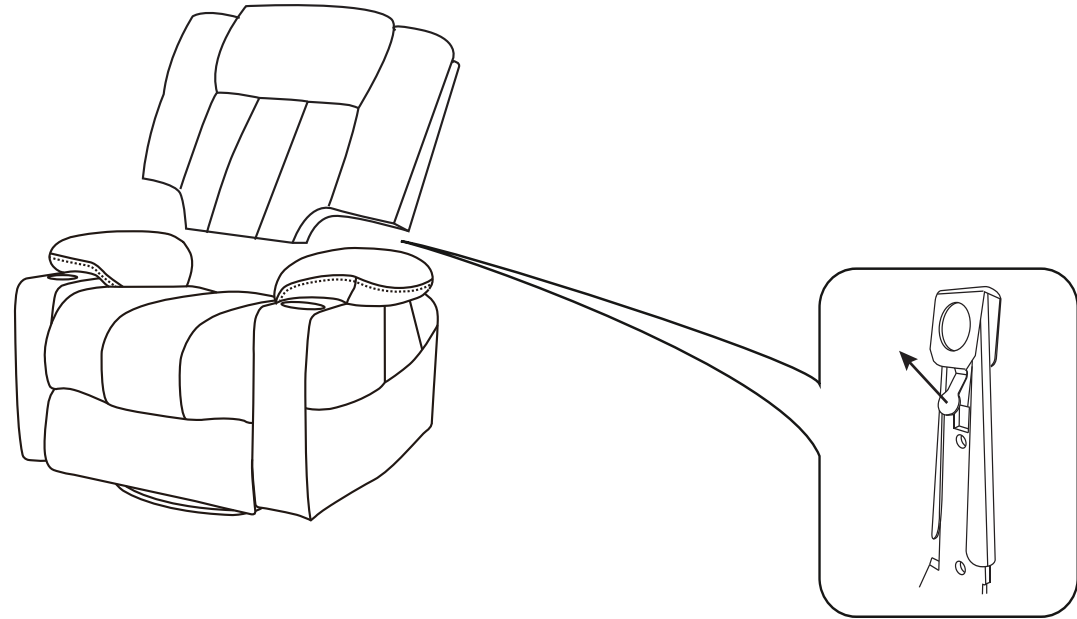

Note: Please grab both of the armrest with hands and then pull the armrest up vertically at the same time.

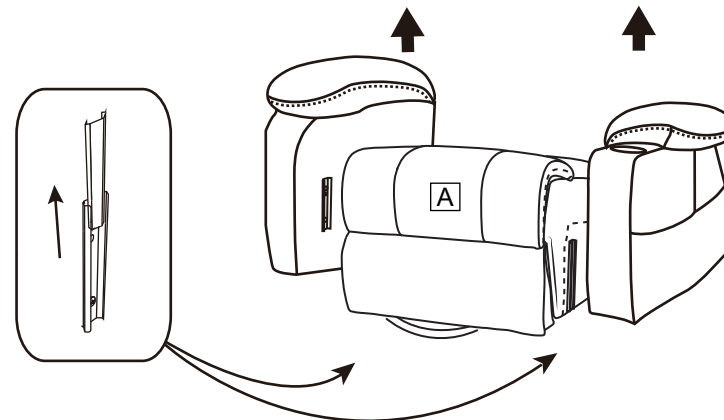

Rocker Recliner Assembly Instruction

How to use remote control?

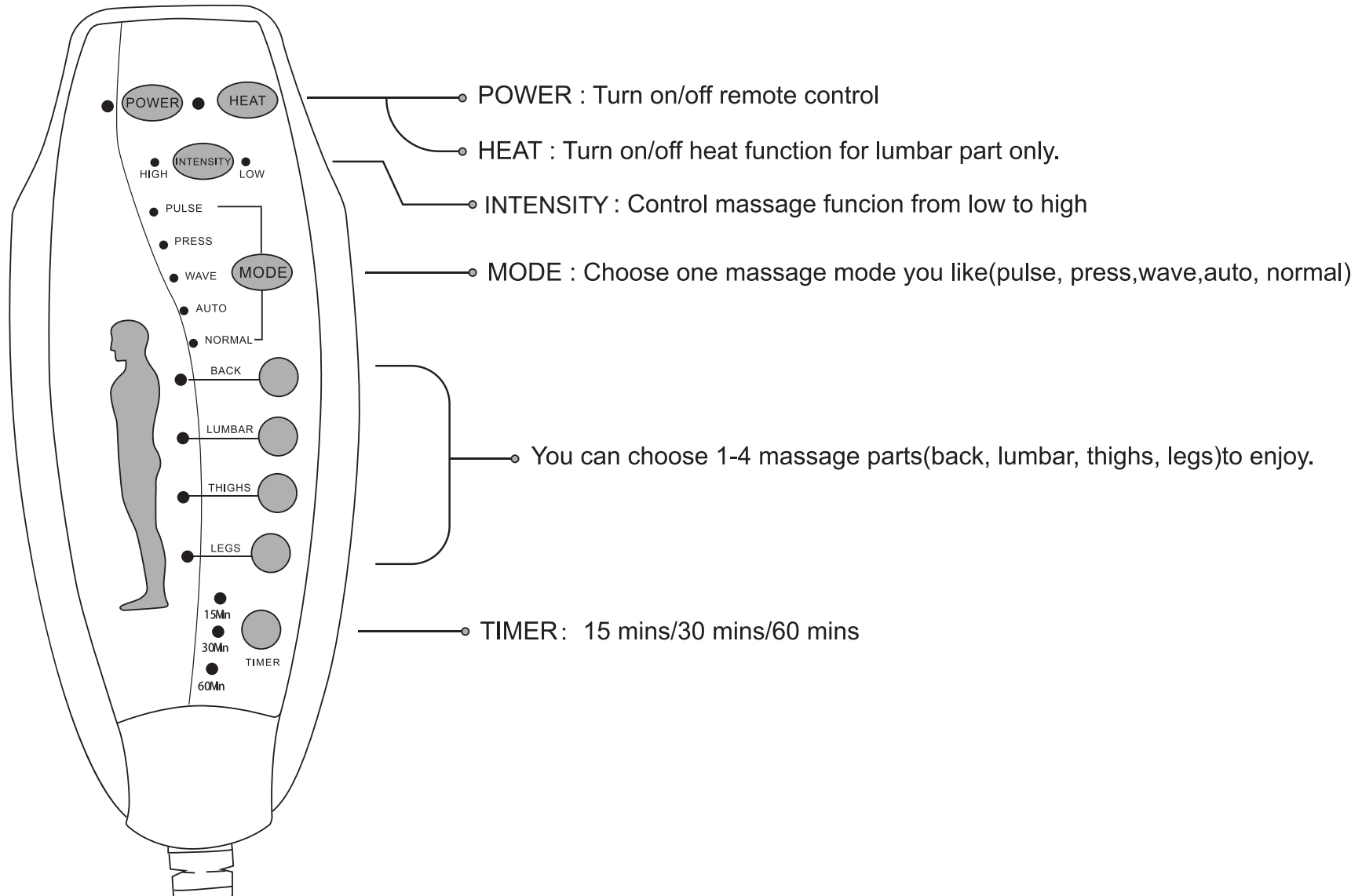

Rocker Recliner Assembly Instruction

FAQ:

1. How to release footrest and recline?

(1) Pull the handle to raise the footrest separately.

(2) Exert some pressure onto the back to recline back.

Note: The chair can not always keep in reclined position when you leave the chair.

2. How to make the footrest go back down?

(1) Please try to keep the back of the chair in the seated position, It's a new chair so need more strength to lock down and you can try some times to close footrest with some force and it will work. When you hear a click sound, footrest closed.

(2) Another solution is get out of the chair and try to push the footrest back with your hands. And it will be much easier after several times use, please note it.

3.Q: Missing parts when received.

A: Please check if you already received two boxes we shipped to you. Sometimes the two boxes will not arrive in same date, hope you can wait for 2-3 more days or contact us for more help.

If you already have two boxes, please kindly send us messages to let us know the name of missing part regarding to the first page of instructions. We will send replacement to you ASAP.

4.Q: Some parts damaged when arrived.

A: Please send clear photos about damaged part to us as attachment, we will check and offer you best solution soon.

5.Q: The massage function does not work.

A: Please check if all the wires were connected correctly. If you have connected all wires correctly, please try to re-plug all the wires to avoid poor wiring contact problems.

If the massage still does not work after you have re-plugged all the wires, then check these 2 parts:

Part 1: The indicator lights on massage remote control are working? YES or NO

Part 2: The USB ports are charging properly? YES or NO

After confirming the answers to these 2 questions, contact us by email and let us know the answers, we will offer you a solution for this issue.

6. Q: The Heat function does not work or can't feel.

A: Please check all wires connection the same as question 5 first. If the remote also works well, you will need wait for 5-10 mins after you press the "HEAT" button. The heating function only works at lumbar position and the heat temperature isn't very hot.