

Metal Garden Shed

OWNER'S MANUAL

Size 5 Ft X 3 Ft Option B

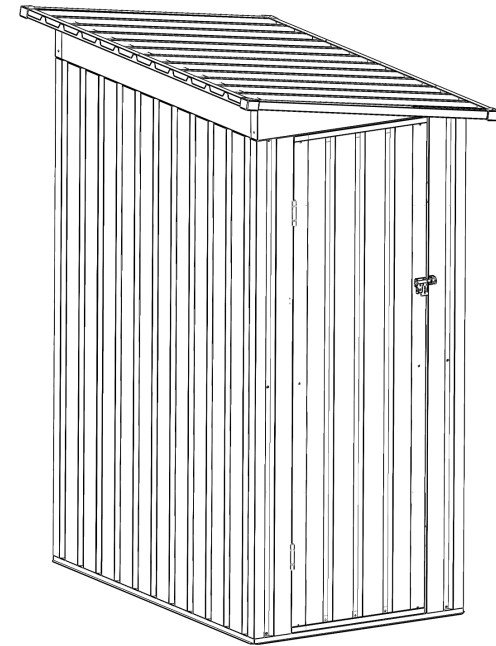

Tall walk in Shed

Quick & Easy Assembly

Ridge Reinforced walls

Wide Double Doors

Available in Various Sizes

Take care of sharp edges;

Please wear gloves;

It will take 2 people 2 - 3 hours to install.

exploded view

First, open the package and check the list on the first page to make sure all accessories are included. If you find any missing accessories, please contact us immediately and we will replace them as soon as possible.

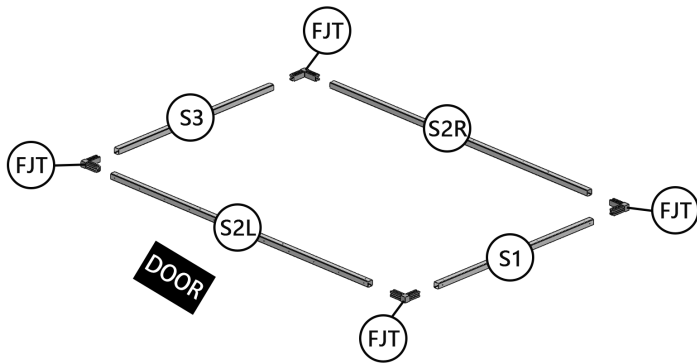
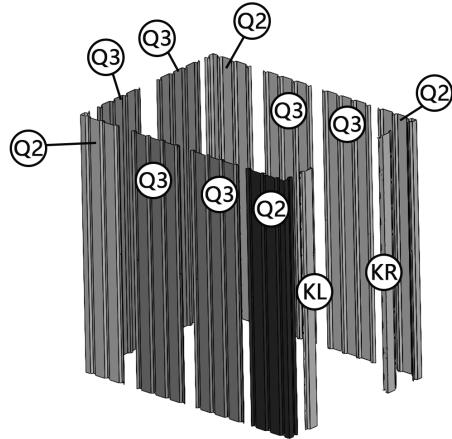
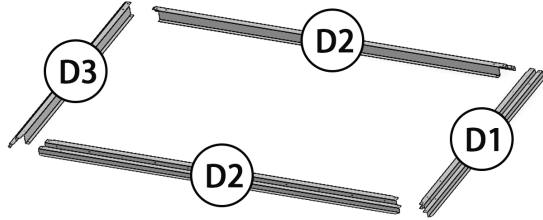

exploded view

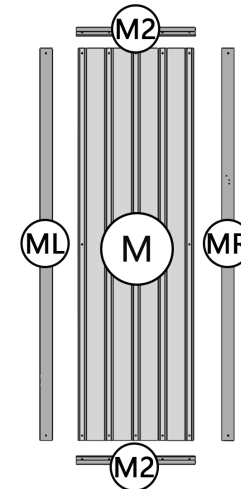
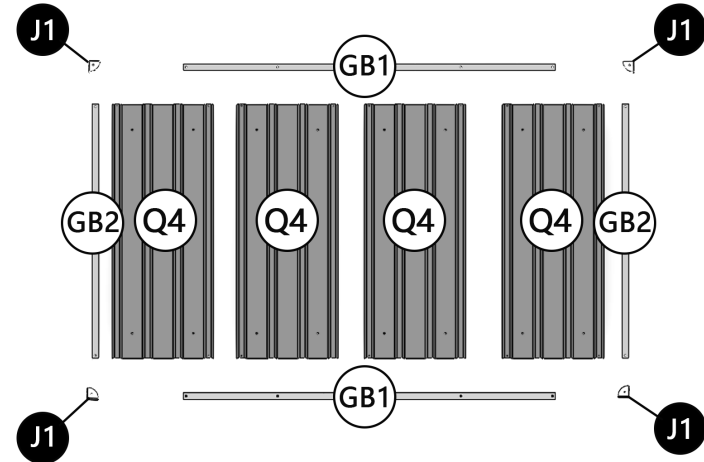
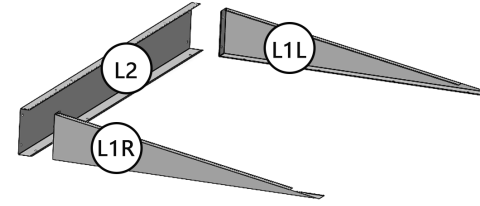

About Assembly

General steps:

Please read these instructions carefully before the assembly begins, and fully understand the assembly method and related details. Open the carton and carefully check the instructions and diagrams to confirm all the parts.

Preparation for installation:

The location of the cottage must be level. If the surface is uneven, the part holes may be misaligned. Make sure the carport is properly secured.

Recommended Tools:



gloves



Electric drill



Safety Helmet Hat



goggles



Phillips screwdriver

Safety Precautions :

Parts may have sharp edges. Please wear gloves when handling these items and safety glasses when punching holes. Safety shoes are recommended. Please do not build and install in a windy environment. Make sure to be firmly anchored to solid ground immediately after construction is complete.

Assembly Method:

Unit: mm

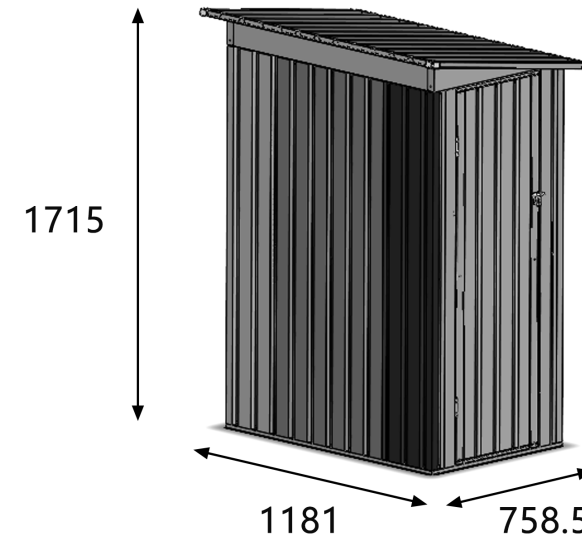

The installation space should be flat, and 1200*800mm at least mm. The foundation is fixed on the ground in this space.

1.Foundation installation

NO.	Part	QTY
D1		1
F1		24

NO.	Part	QTY
D2		2
F8		4

NO.	Part	QTY
D3		1

step1

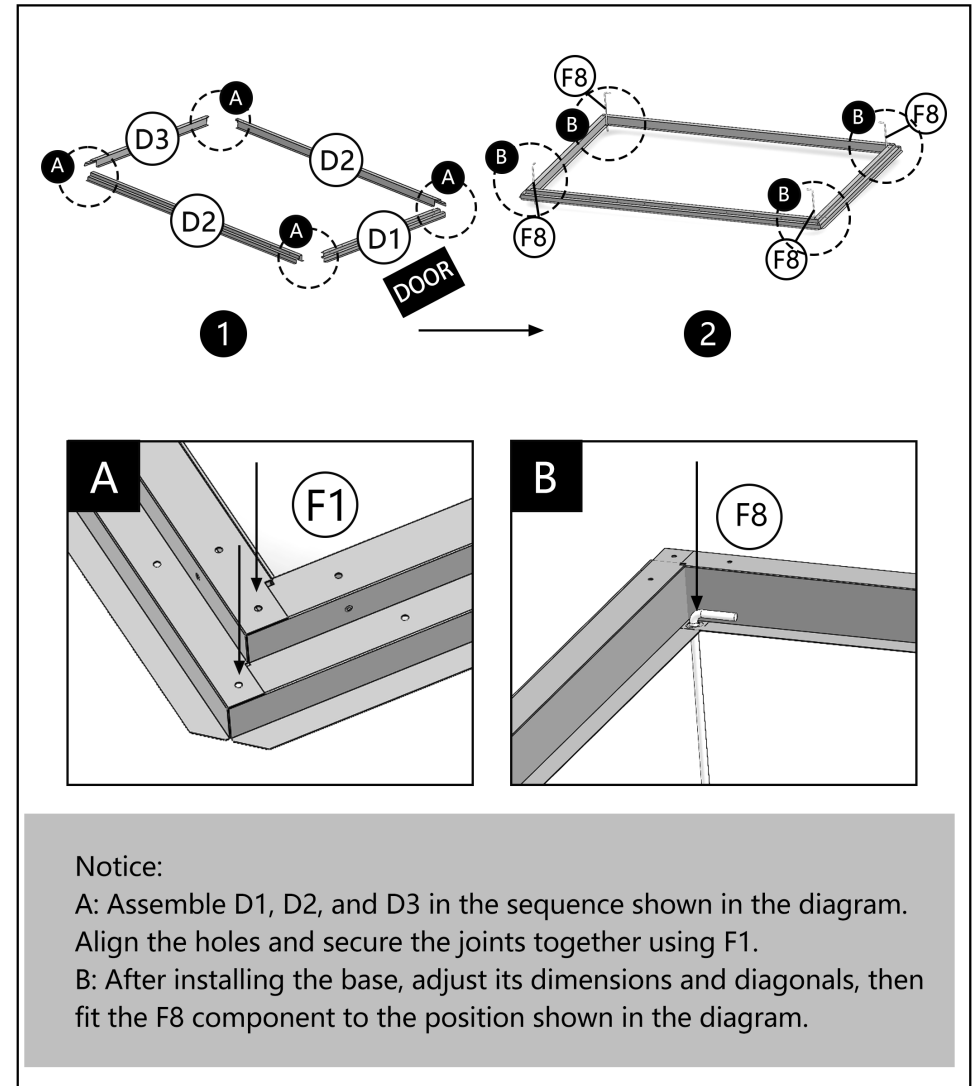

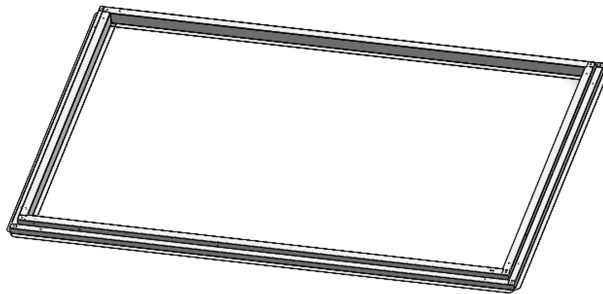

Notice:

- A: Assemble D1, D2, and D3 in the sequence shown in the diagram. Align the holes and secure the joints together using F1.
- B: After installing the base, adjust its dimensions and diagonals, then fit the F8 component to the position shown in the diagram.



2.Upper frame installation

NO.	Part	QTY
Q2		4



NO.	Part	QTY
F1		8

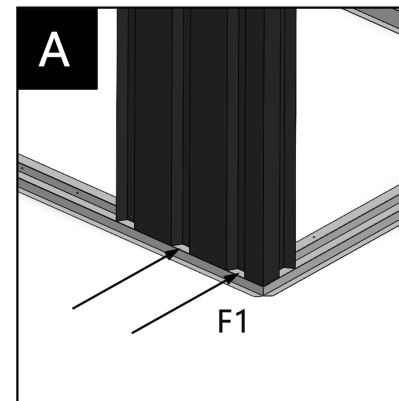
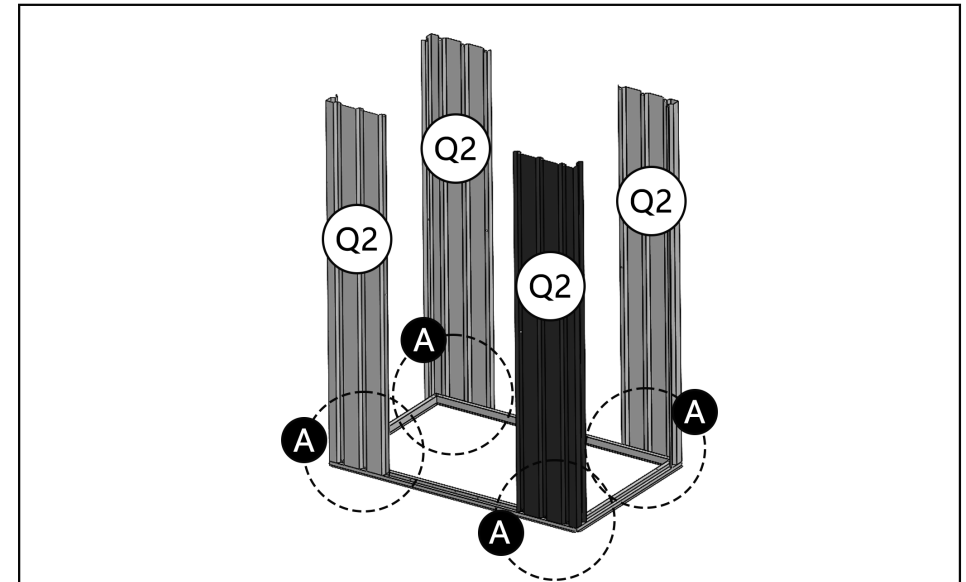
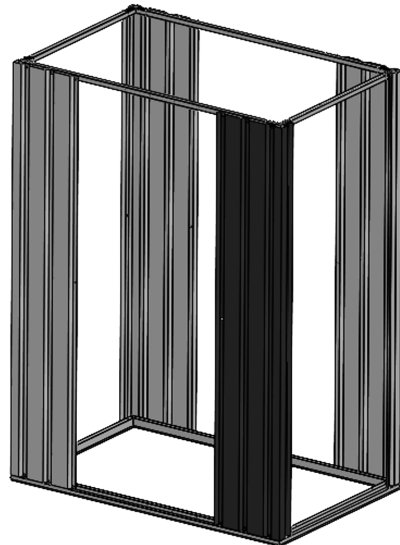

step2



Notice:
Position Q2 as shown in the diagram and secure the base to the frame using F1. (Leave the holes on both sides free for installing other wall panels.)

Assembly Method: In order to distinguish the orientation of the part, pay attention to the position of the hole in the example drawing

NO.	Part	QTY
S2L		1
S1		1

NO.	Part	QTY
S2R		1
FJT		4

NO.	Part	QTY
S3		1

step3

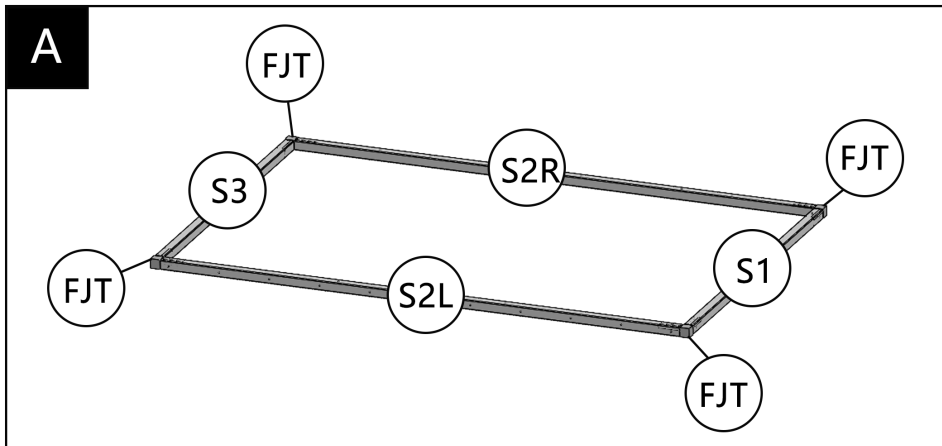
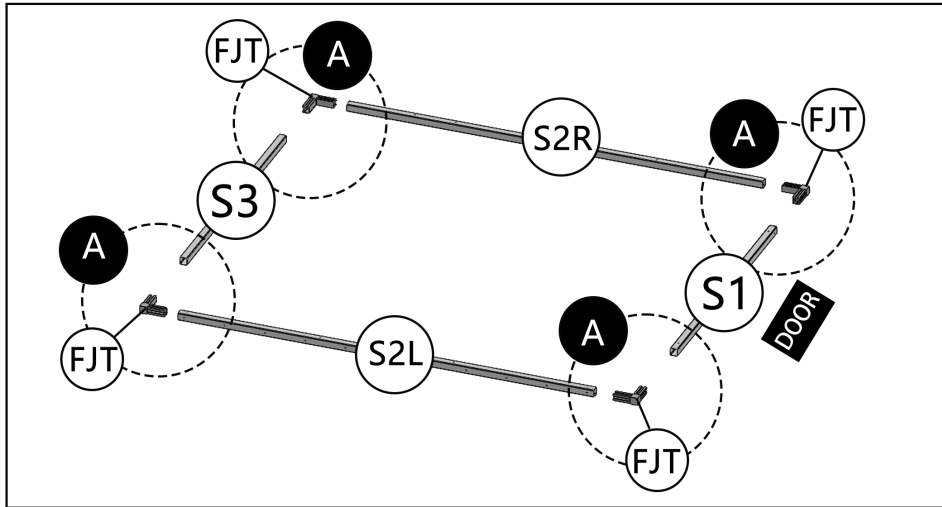

Notice:
Assemble the components according to the layout shown in the diagram.

5

Assembly Method: In order to distinguish the orientation of the part, pay attention to the position of the hole in the example drawing

NO.	Part	QTY
F1		8

step4

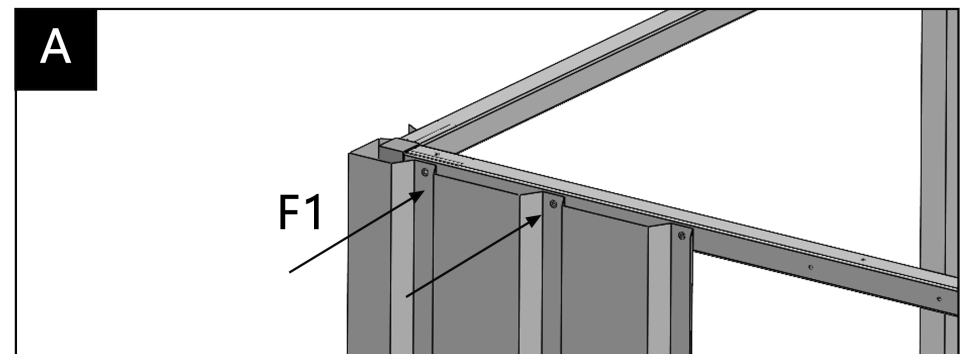
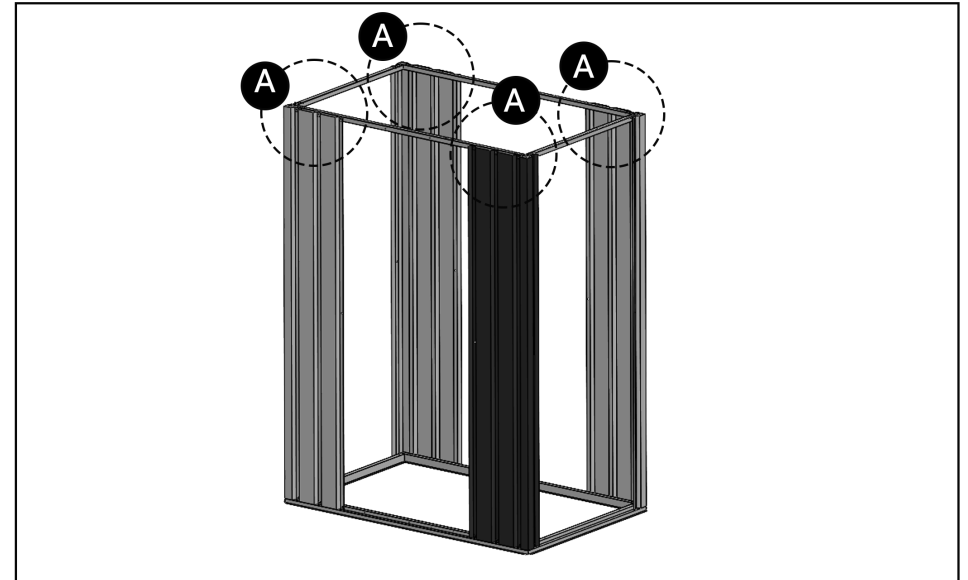



Notice:
Position the upper frame against the inner side of the wall panel and secure the wall panel to the frame using F1. (Leave the holes on both sides open for subsequent installation of other components.)

6

3.Wall Panel and Door Frame Installation

NO.	Part	QTY
Q3		6

NO.	Part	QTY
F1		42

NO.	Part	QTY
F11		9

step5

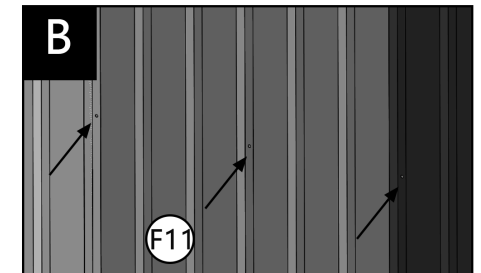
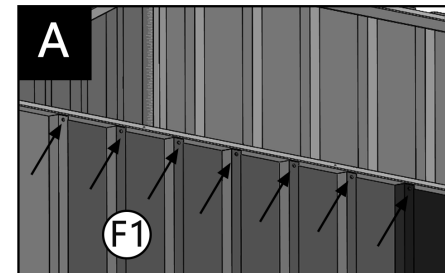
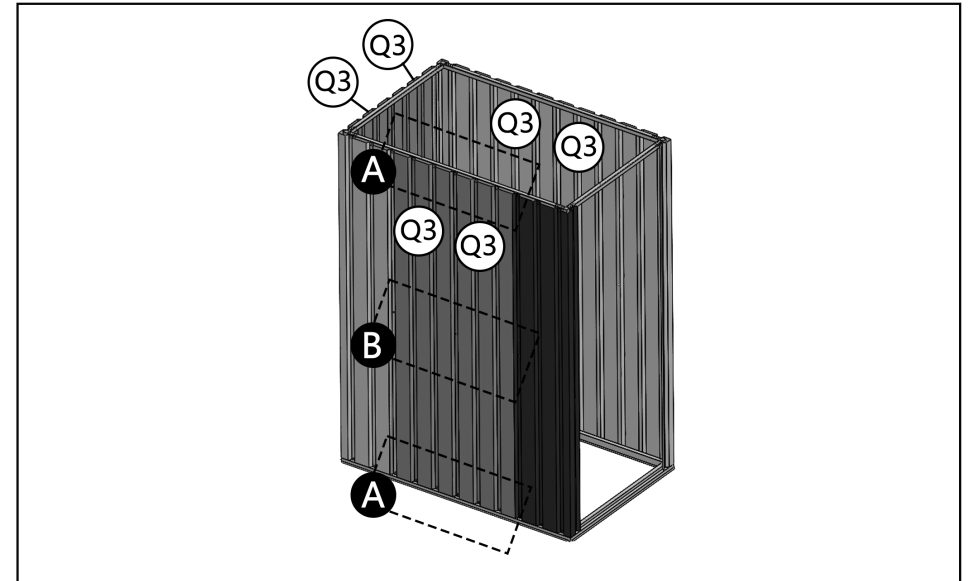
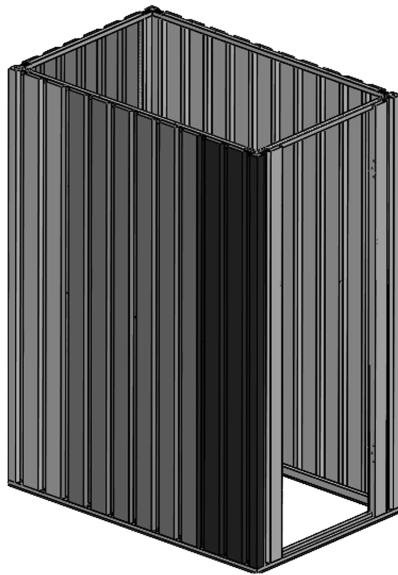

Notice:

Stack Q3 components sequentially in the positions indicated in the diagram. Secure the upper end to the top frame and the lower end to the bottom frame using F1. Fasten the connection points of the central wall panels with F11.

Assembly Method: In order to distinguish the orientation of the part, pay attention to the position of the hole in the example drawing

NO.	Part	QTY
KL		1
F11		2

NO.	Part	QTY
KR		1

NO.	Part	QTY
F1		8

step6

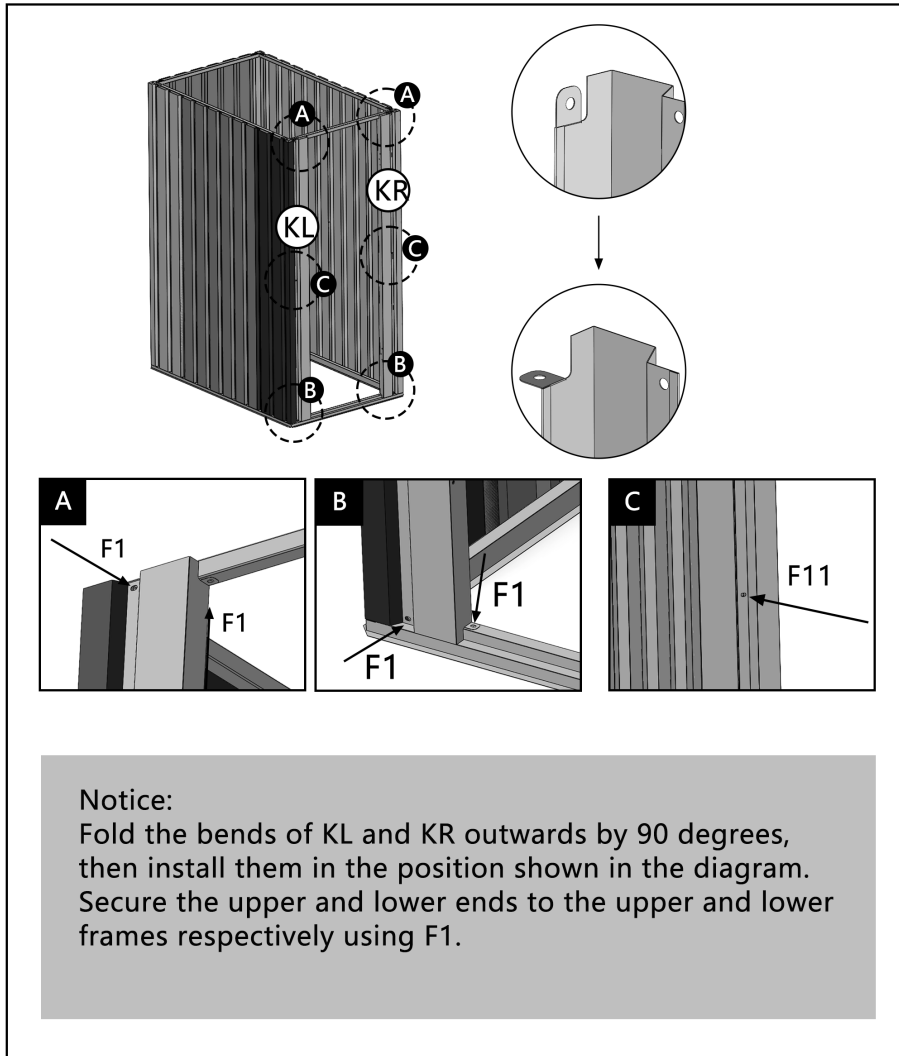

4.Mountain Peak Installation

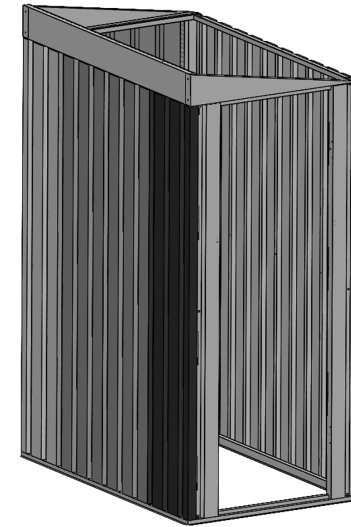

Assembly Method: In order to distinguish the orientation of the part, pay attention to the position of the hole in the example drawing

NO.	Part	QTY
L1L		1
F11		4

NO.	Part	QTY
L1R		1

NO.	Part	QTY
L2		1

step7

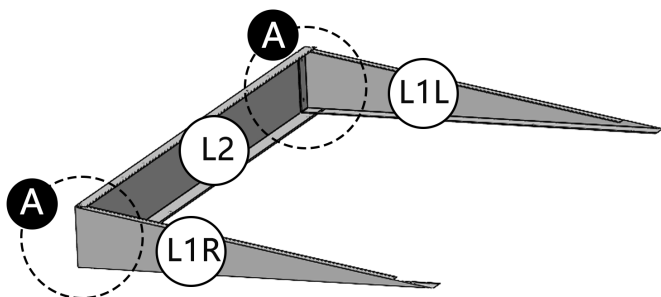

Notice:

A: Connect L1L and L1R to L2, align the holes, and secure them together using F11.

11

Assembly Method: In order to distinguish the orientation of the part, pay attention to the position of the hole in the example drawing

NO.	Part	QTY
F1		12

step8

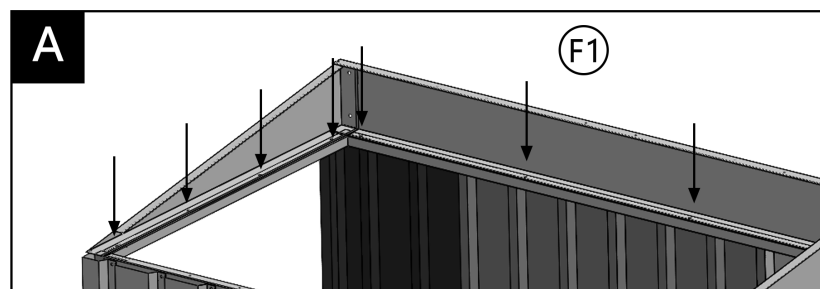
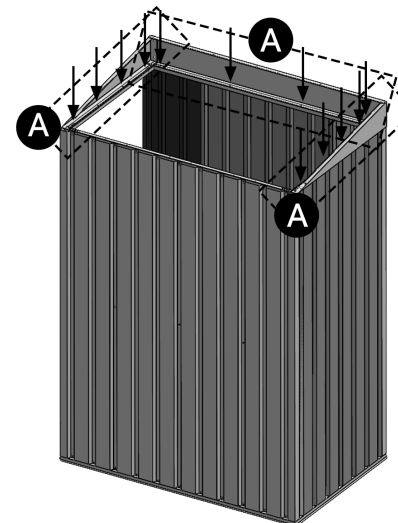

Notice:

A: Place the assembled L1L, L1R, and L2 components onto the frame. Align the mounting holes and secure them to the frame using F1.

12

5. Installation of ridge tiles

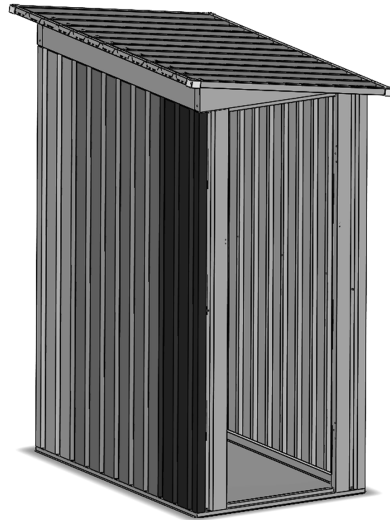

NO.	Part	QTY
Q4		4

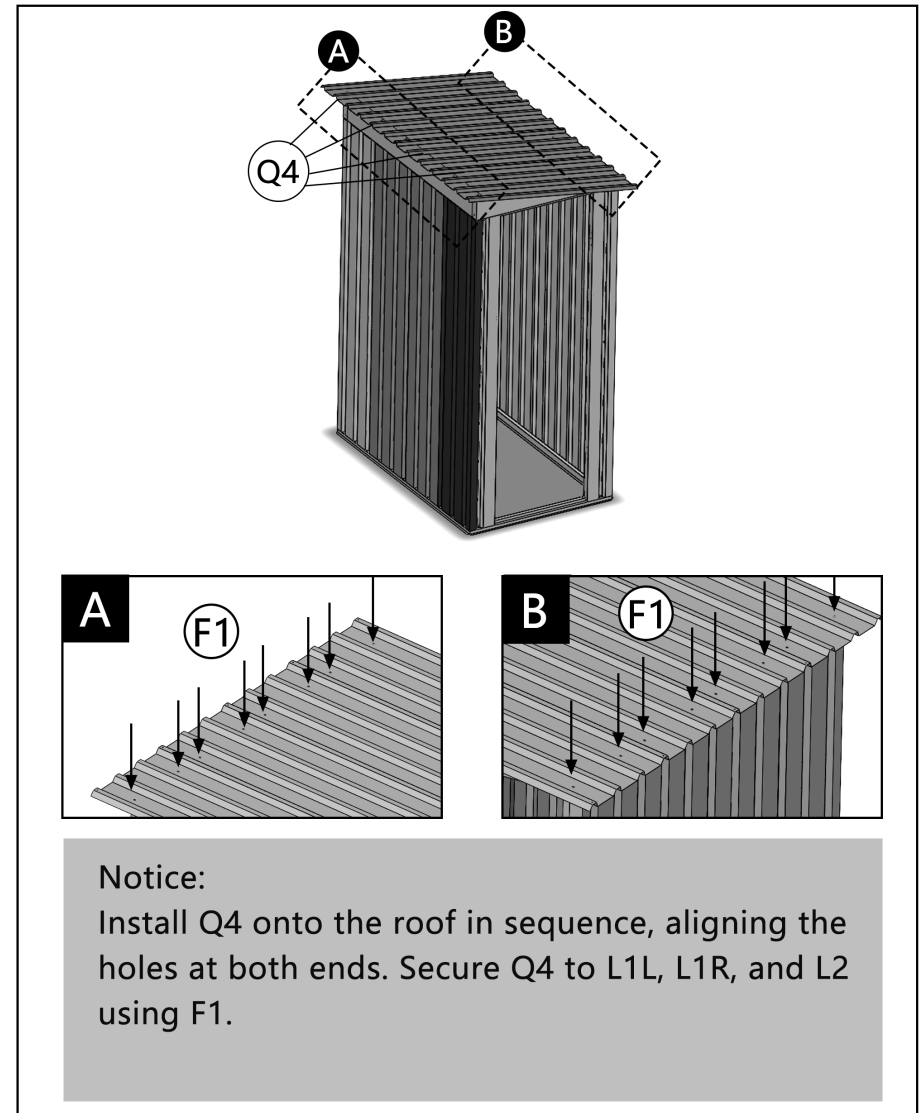

NO.	Part	QTY
F1		16

step9



Assembly Method: In order to distinguish the orientation of the part, pay attention to the position of the hole in the example drawing

NO.	Part	QTY
GB1		2

NO.	Part	QTY
GB2		2
J1		4

NO.	Part	QTY
F1		10

step10

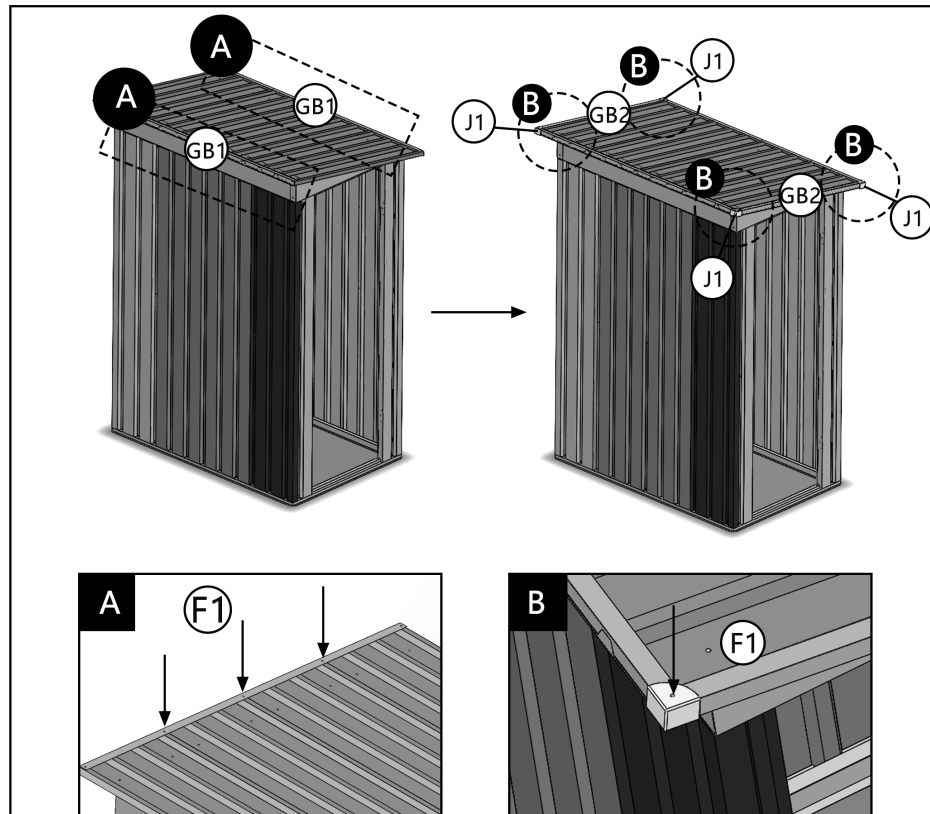

Notice:
 A: Place GB1 in the position shown in the diagram. First use F1 to secure the center hole to Q4. (Leave the left and right side holes open for later installation.)
 B: After placing GB2 in the position shown in the diagram, place J1 in the corner. Use F1 to secure GB1, GB2, and J1 to Q4.

6.Installation of the main gate

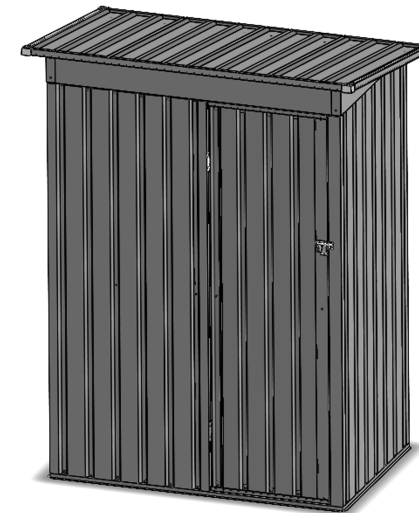

Assembly Method: In order to distinguish the orientation of the part, pay attention to the position of the hole in the example drawing

NO.	Part	QTY
ML		1
F4		1

NO.	Part	QTY
M		1
F10		4

NO.	Part	QTY
HY		2

step11

Front

Front

A

Notice:
Take out ML and HY. Place HY on the side of ML. Use F10 to secure HY to ML.

B

Notice:
Place M inside ML and use F4 to secure ML and M together.

Assembly Method: In order to distinguish the orientation of the part, pay attention to the position of the hole in the example drawing

NO.	Part	QTY
MR		1
F11		6

NO.	Part	QTY
M2		2

NO.	Part	QTY
F4		5

step12

Front

Front

A

B

C

Notice:
 A: Place MR on the opposite side of M and secure MR and M together using F4. (Ensure the side of MR with more holes faces outward.)
 B: Secure the connection holes between M2 and M from the outside using F11.
 C: Secure the holes at the four corners of the door from the outside using F4.

Assembly Method: In order to distinguish the orientation of the part, pay attention to the position of the hole in the example drawing

NO.	Part	QTY
SK		1

NO.	Part	QTY
F10		6

NO.	Part	QTY
F1		6

step13

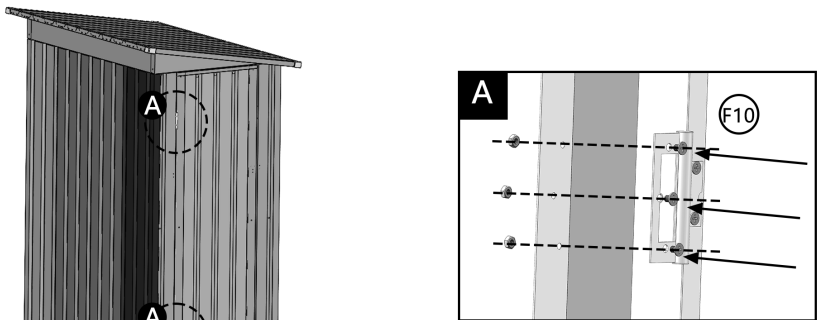

A: Place HY onto KL, align the holes, and secure it with F10.

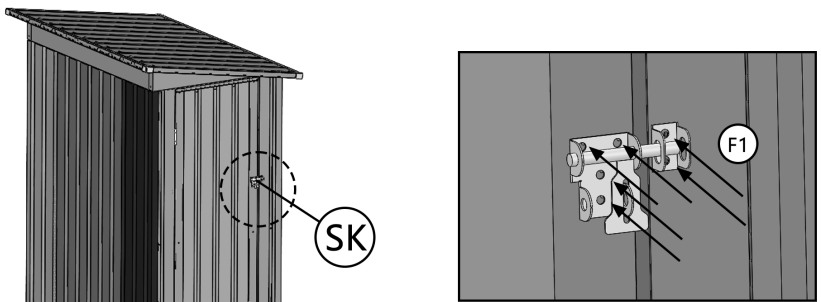

B: Position SK as shown in the diagram, align the holes, and secure it with F1. (If there are no holes on MR, check if it is installed upside down.)

