

4 Way Geometric Spotlight

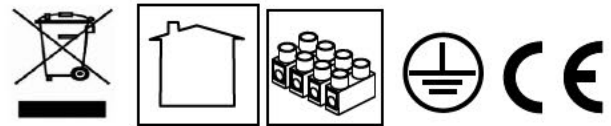
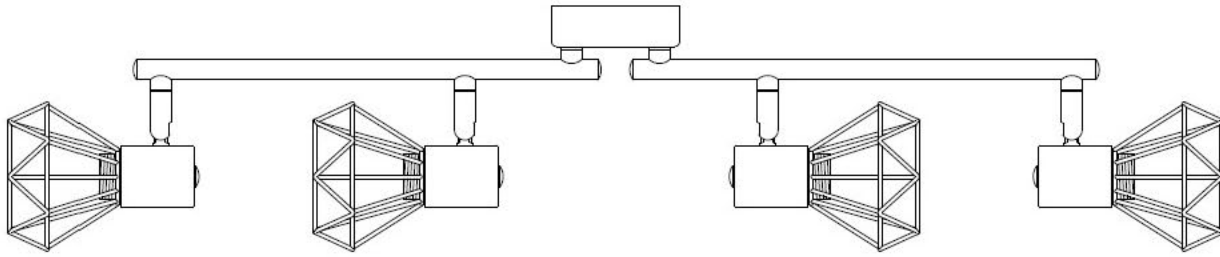

Before You Begin

- Unpack all components onto a flat surface that will not damage them or allow them to become dirty
- Take extra care when handling glass
- Check that all components are correct and present
- Familiarise yourself with the product, its component parts and how it is assembled.
- Keep all packaging until after a successful installation and retain the instructions for future reference

Suggested tools required for installation process as follows:



- Screwdriver - with insulated handle.
- Pliers - for twisting wire and cutting cable
- Drill - choose appropriate drill bits for your chosen location and mounting surface

COMPONENT PARTS AND FITTINGS

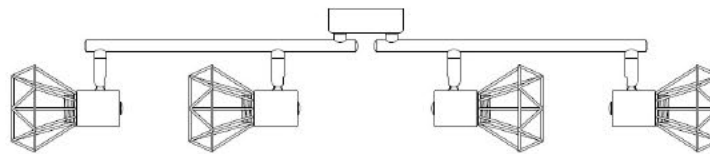

Ceiling Light
(Pre-wired)



Bracket x 1
(Included 2 screws - fitted on the ceiling plate)



Terminal Block x 1



Screw & Wall Plugs x 2
(Included in pack)

We regret that we are unable to give advice on internal house wiring

WARNING:

Before proceeding, make sure the ceiling light is switched OFF and the electricity is switched OFF at the mains supply board

SAFETY:

- Please choose screws and fixings that are suitable for the material that your ceiling is made of, if the ones supplied do not suit
- This is a Class I product and requires an Earth connection – 230 (240) volts ~50hz AC
- This fitting must be permanently wired into the electric system. Always shut off power to the circuit before starting installation work.
- Do not modify or alter any product before or after installation. This will invalidate your warranty and may render the product un-safe.
- Before inserting and replacing bulb(s) make sure that the power is switched off and the bulb(s) have cooled down.
- All connections should be covered by suitable insulation tape
- The terminal block should be housed within the mounting plate or a suitable recess behind the fitting.
- All wiring must conform to current I.E.E regulations
- This product must be installed in accordance with the national building regulations. If in doubt consult a competent electrician

POSITION:

- Do not mount the fitting in a damp atmosphere.
- Be aware of any sunken pipes or wiring before choosing a location.
- Ensure there is a sufficient power supply.
- Ensure sufficient access to the fitting to enable safe maintenance.

IF AT ALL UNSURE, STOP NOW AND SEEK PROFESSIONAL GUIDANCE

ASSEMBLY AND SET-UP:

- Ensure power is switched **off** at mains control unit [consumer unit or 'fuse-box'] (**DIA. 1**)
- Unscrew the two side screws to remove bracket from the ceiling plate (**DIA. 2**).
- Use mounting bracket as template to mark holes, Drill suitable holes into the ceiling joist, ensuring that they align with the holes in the bracket and screw the bracket onto the ceiling using suitable screws (**DIA.3**)
- Make electrical connections, taking note now of the point below. Please note the image shown in **DIA.4** is only a general guide and may not relate to your application. There are many variations in domestic wiring so if you are unsure seek assistance.
- Insert the assembled terminal block onto the earth tab fixed on the bracket. This earth tab replaces one of the earth tails from the product, so you should have one earth tail and the earth tab entering the same slot on the terminal block.
- Insert the bulb(s) into the lamp holder(s) – using the bulb type & wattage as stated on the lamp holder & fit the decorative shades. (**DIA.5**)
- Switch ON at mains control unit [consumer unit or 'fuse-box'] (**DIA. 6**)

AFTERCARE AND MAINTANENCE:

- Always disconnect power supply when servicing or cleaning.
- Clean only with a dry or slightly damp cloth.

DIA. 1

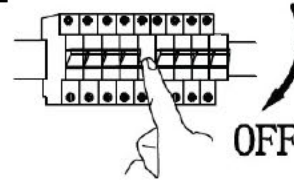

DIA. 2

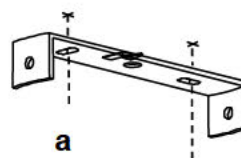

DIA.3

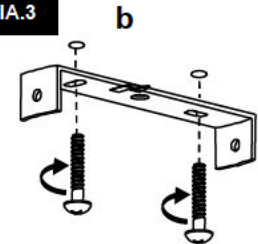

DIA.4

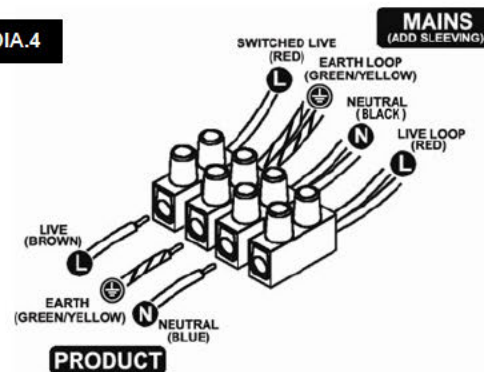

DIA. 5

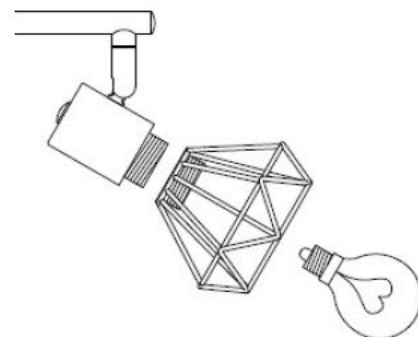

DIA.6

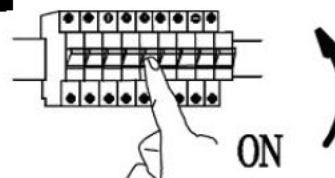

IF IN DOUBT ABOUT FITTING THIS PRODUCT, PLEASE CONSULT A QUALIFIED ELECTRICIAN