



CARE AND MAINTENANCE

Wipe clean with a soft, dry cloth. Test the cleaning method on a hidden area before using them over the entire area.

NOTICE

- * Please make sure that you have all parts indicated before you begin assembly of this item.
- * This item should be assembled on a soft surface to prevent scratching the finish during assembly.
- * This item may require periodic tightening.
- * Do not tighten bolts until completely assembled.

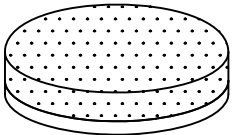
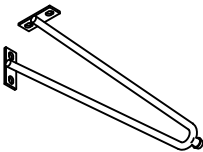
Part List and Hardware List

PIECE	DESCRIPTION	PICTURE	QUANTITY
A	Seat Cushion		1x
B	Leg		4x
H1	Allen Bolt	 1/4"x 5/8"	16x
H2	Allen Key	 M4	1x

Product Dimensions: 16"DIAX17-3/4"H

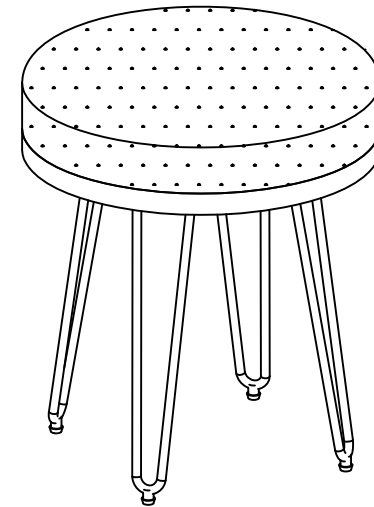

PREPARATION

Before beginning assembly of product, make sure all parts are present. Compare parts with package contents list and hardware contents list. If any part is missing or damaged, do not attempt to assemble the product.

Estimated Assembly Time: 10 minutes.

Tools Required for Assembly (included): Allen Key

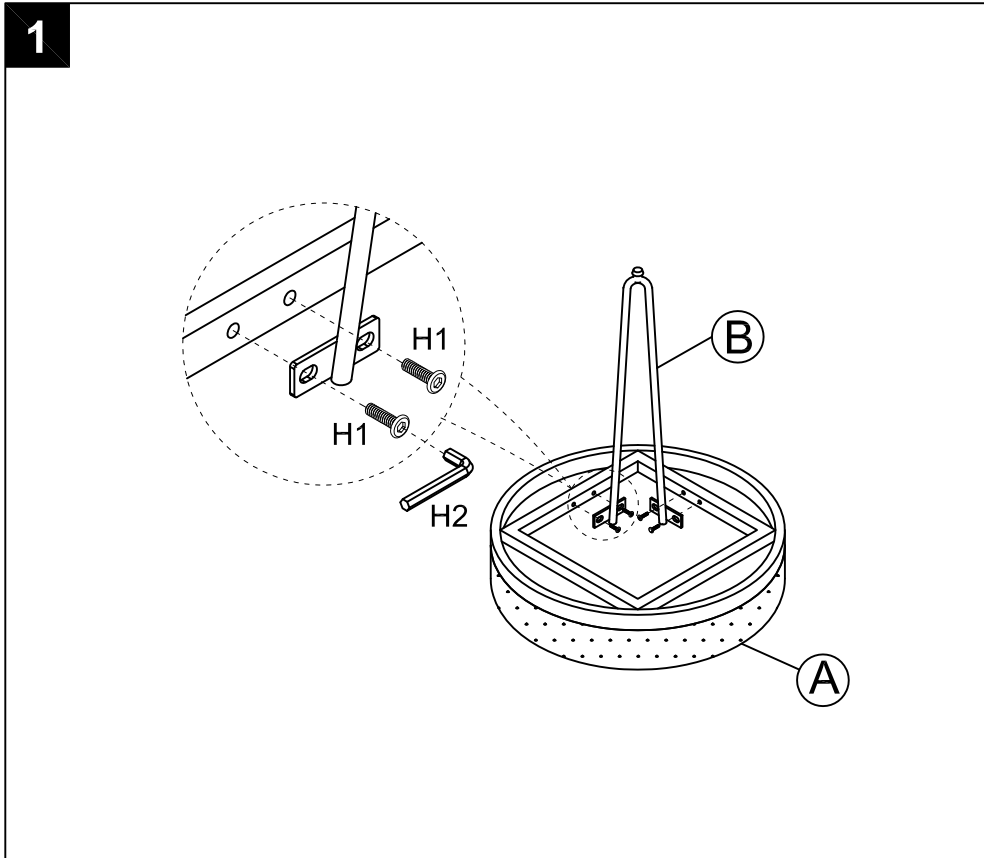

Step 1

Attach the 4 * Legs (B) with Seat Cushion (A) by using Allen Key (H2) to lock with Allen Bolts (H1) as picture.

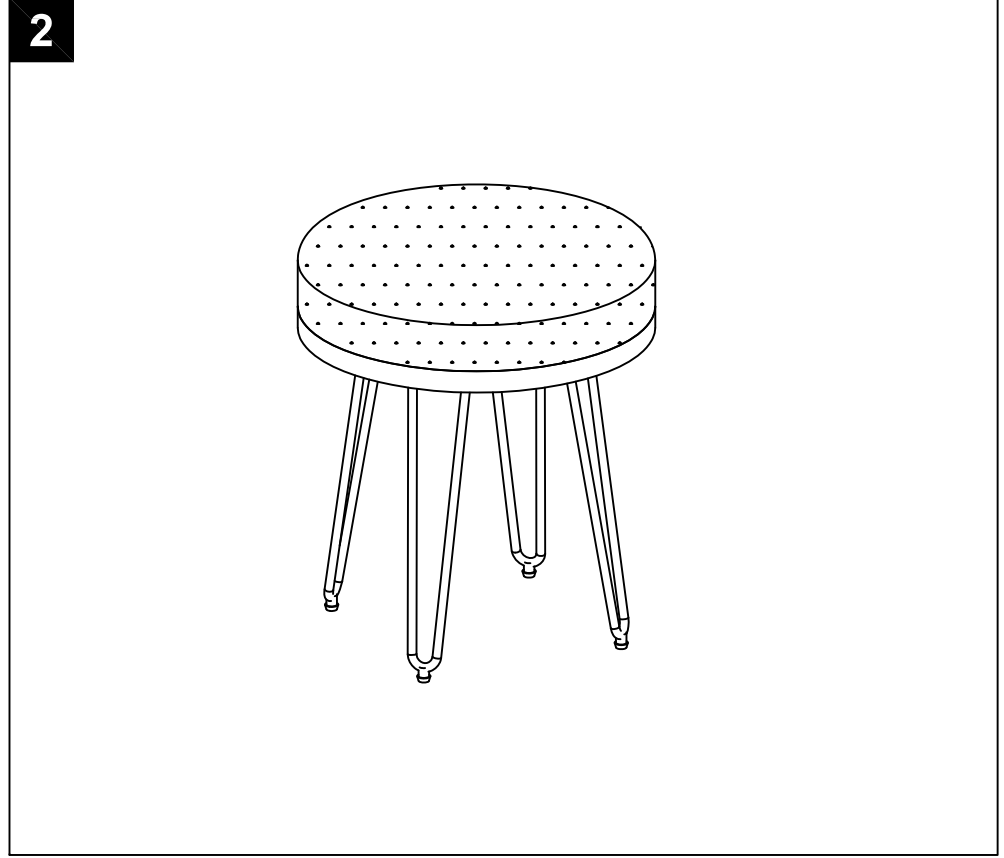

Step 2

Assembly is completed.