

# ASSEMBLY AND OPERATING INSTRUCTIONS

## GAZEBO

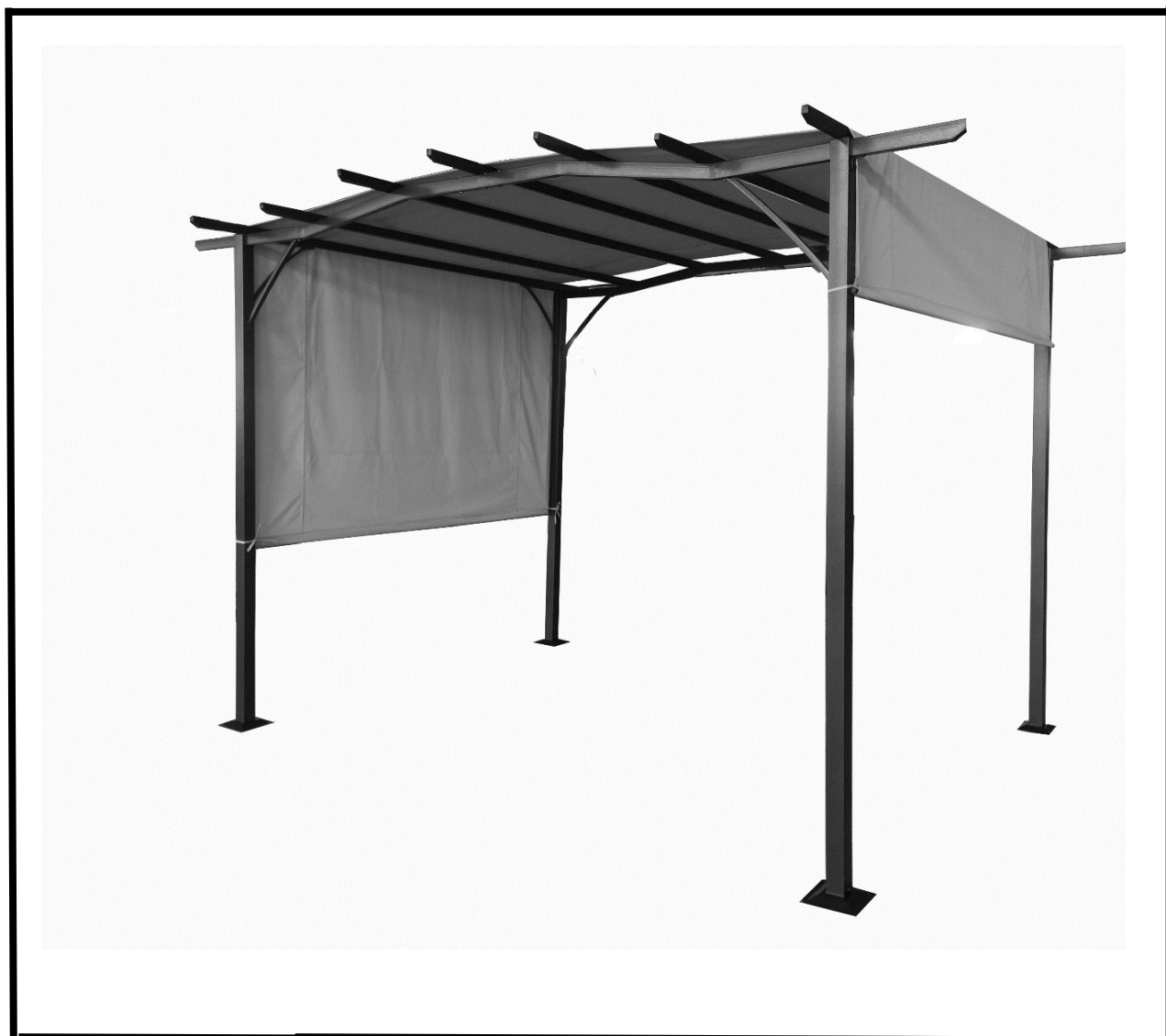

## **Warning**

1. It is the consumer's responsibility to comply with any relevant local planning requirements.
2. TWO persons are required for assembly. The tools required are a screwdriver, stepladder and other relevant safety items such as gloves. We recommend the use of protective equipment.
3. This gazebo will take at least 1-2 hours to set up. You must allow enough time to complete the assembly. Do not leave it unattended if not fully assembled, even if bolted to the ground.
  - A. Make sure that all components are in the box. Read instructions carefully before starting the assembly.
    - b. Follow all instructions carefully to assure the strength of the gazebo.
    - c. In order to avoid damage to the gazebo and its components, use appropriate Tools. Do not use the structure as a support; a stepladder is recommended.
    - d. Check all screws on a regular basis to maintain the solidity of the structure.
    - e. Keep the instructions and parts list for further use.
4. The screws/bolts to anchor to a wooden deck and concrete patio are not included.

## **Maintenance**

- In the event that your gazebo needs replacement parts, repairs or you require assistance with regards to assembly; please contact our customer sales team.
  - For cleaning: Use a mild domestic soap or soft detergent and wash with warm water using a sponge or microfibre fabric. Rinse with clean water.
- To preserve the fabric (canopy) we recommend the use of a UV protector spray like Fabsil this Block the harmful UV rays from damaging the fabric and also will keep the fabric protected from discoloration.





## **ATTENTION**





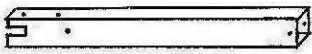

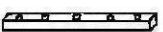
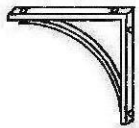
Please do not leave your canopy closed during high winds / rain or winter months and the water will collate on top causing a pool and damaging the structure.

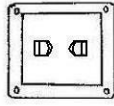
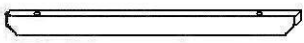
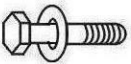
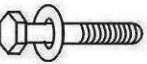
## **EXCLUDED:**

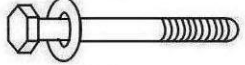
- Damages due to vandalism, abuse and incorrect use of the product are not covered by the warranty
- Damages due to extreme weather conditions such as thunderstorm, hail and high winds are not covered by warranty.

# Part list

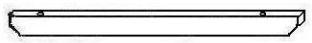
Part#	Figure	Qty
A1		2
A2		2
B		4
C		4
D		4
E		4
F		4
G		2
H1	 M6×16	40
H2	 M6×20	16+1

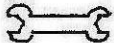
Part#	Figure	Qty
H3	 M6×52	14+1
I		4
J		4
K		2
N		5
W		1
Y		16
Z		1

**STEP ONE:**  
CONNECT 2 X PART B WITH THE MIDDLE CONNECTOR  
PART C USING H1 BOLTS

1.

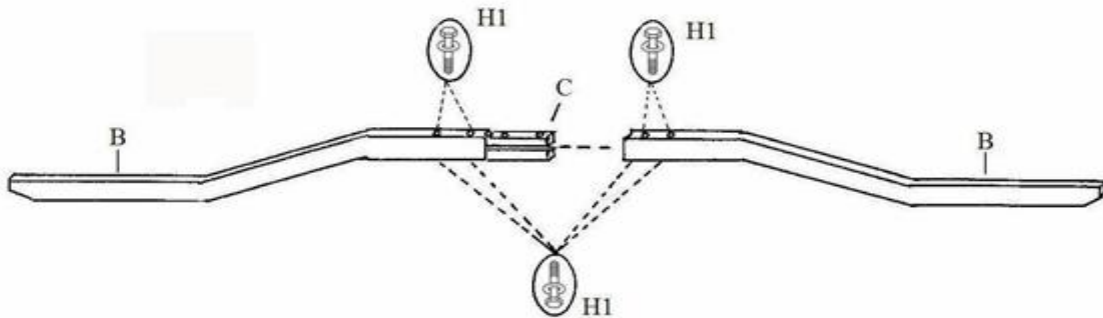

**STEP TWO:**  
**BOLTS NEEDED: H1**

**2A. CONNECT PART F WITH A1 (A2).**

**2B. CONNECT YOUR JOINED 2 x PART B TO YOUR A1 (A2)  
LEG.**

**2C. CONNECT PART E TO A1 AND B AND REPEAT FOR PART  
J (AS SHOWN BELOW)**

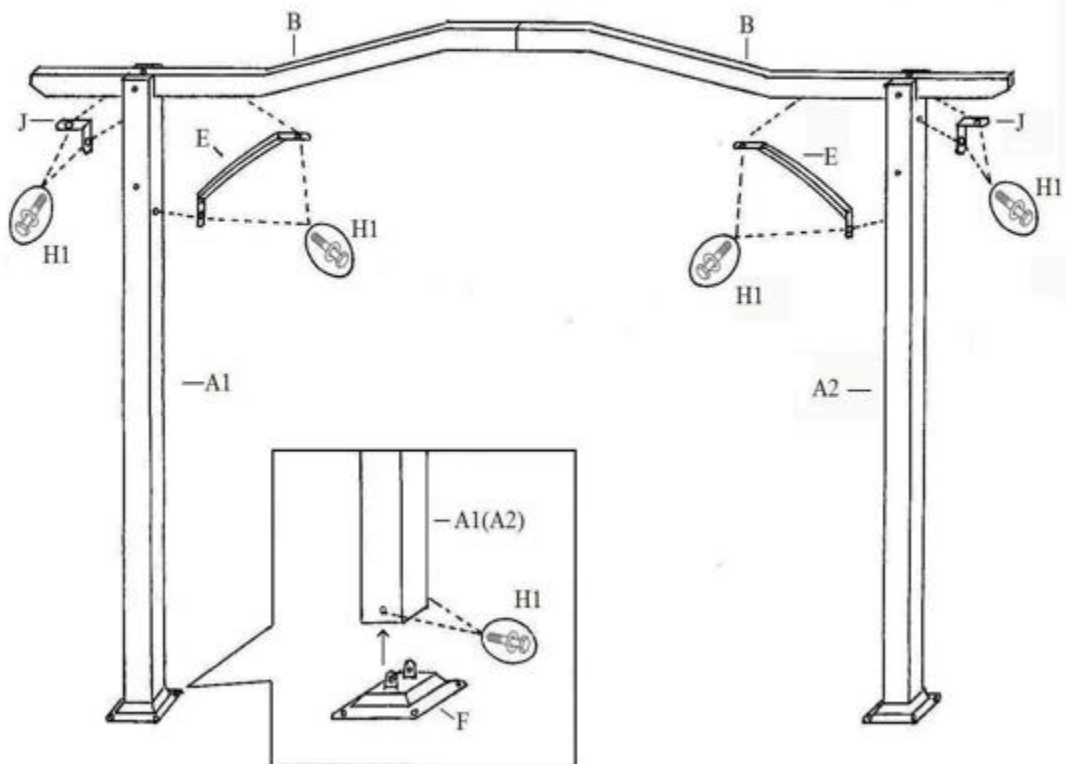

**STEP THREE:**

**BOLTS NEEDED: H3 & H2**

**3A. CONNECT PART G TO PART B WITH PART I INBETWEEN.**

**3B. CONNECT PART N TO B.**

**3C. CONNECT PART D TO PARTS G AND A1 (A2)**

3.

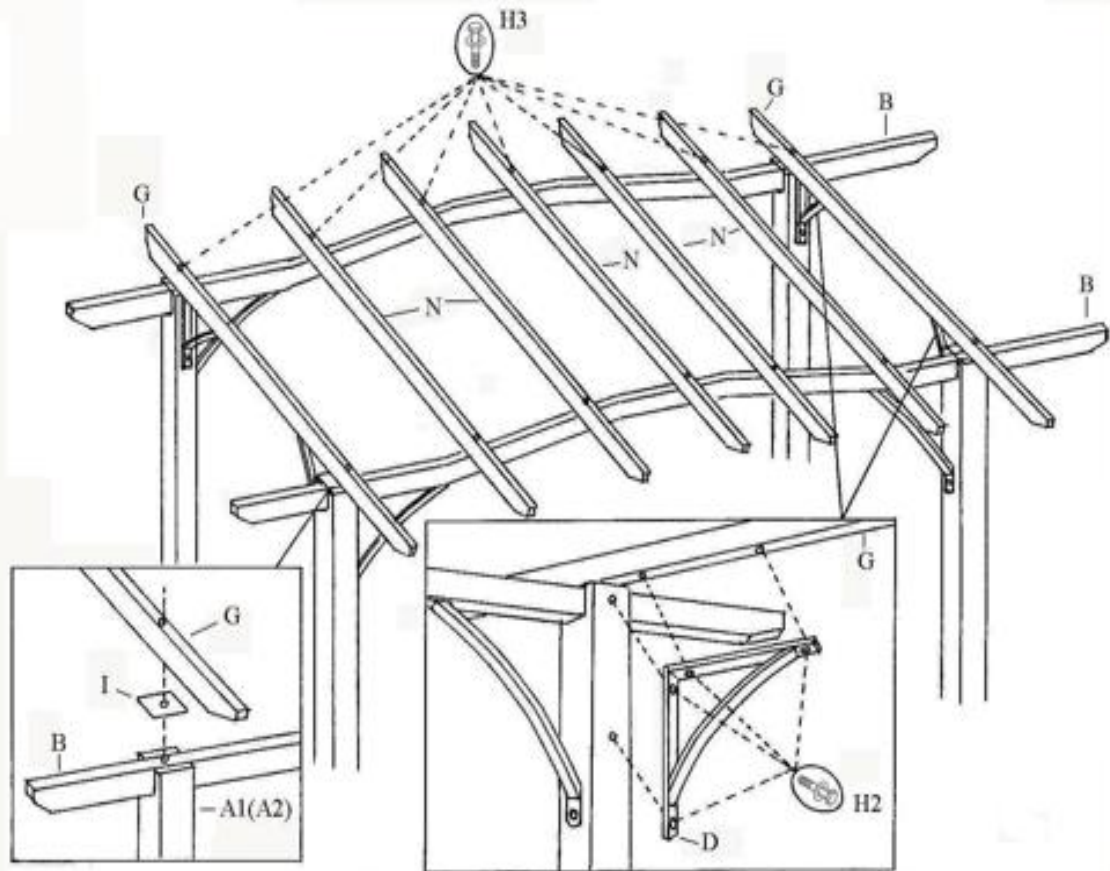

### **STEP FOUR:**

**4A.** SLIDE PART K INTO THE ALLOTTED SECTIONS ON PART W

**4B.** PLACE PART W ONTOP OF YOUR BUILT FRAME

**4C.** TIE EACH END OF PART W TO EACH LEG

**4D.** USE PART Y TO SECURE YOUR FRAME INTO THE

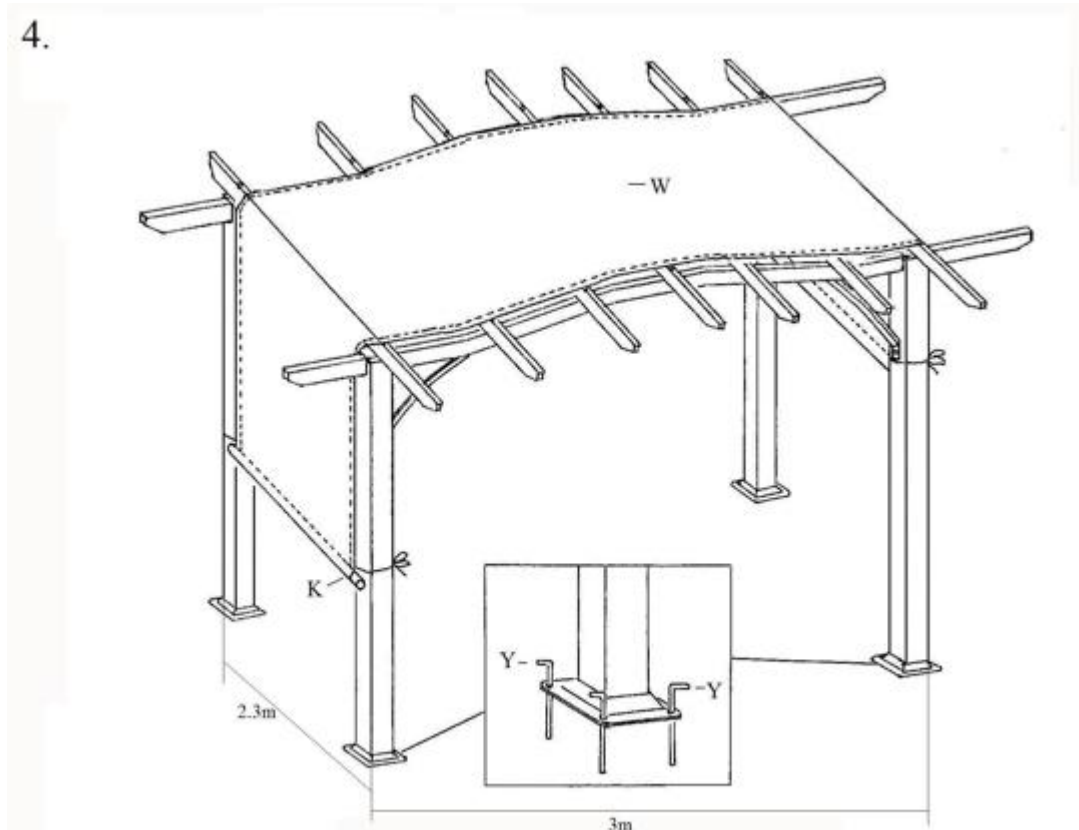

**Note:** First adjust the size as shown in figure, then the stack Y can be inserted into the post base.

## **CARE INSTRUCTIONS**

**Please ensure your frame is secured to the ground once built. It is advised to remove your canopy during high winds and winter months. Royalcraft recommends using Fabsil to protect your Gazebo roof canopies & curtains**

**It can also be used on cushions & parasols or any material that you leave outside in your garden.**

**Protects against: UV & gives extra waterproofing protection**