

# CHAIR

---

Model # \_\_\_\_\_  
Lot No: \_\_\_\_\_  
Date of Purchase \_\_\_\_\_

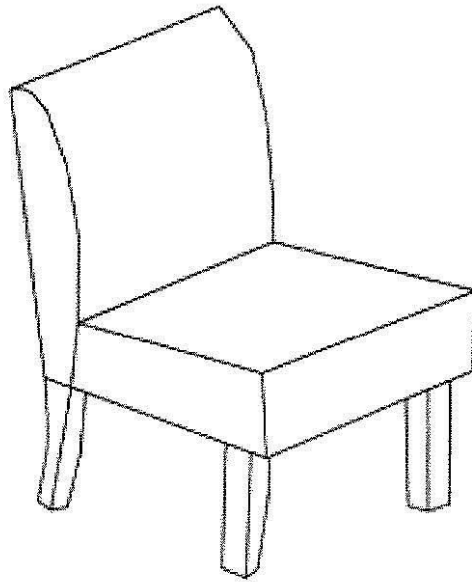

## Parts List/ Assembly Instructions

---

Model #

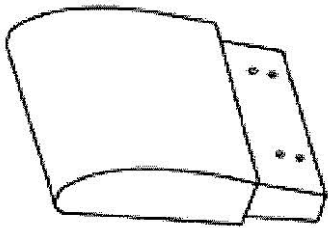

Back Cushion 1 PC



Rear Leg 2 PCS



Front Leg 2 PCS

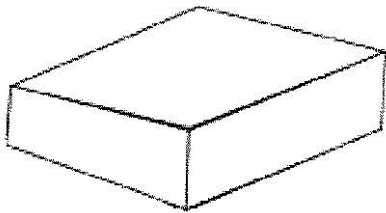

Seat Cushion 1 PC

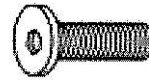

M8 x 50 MM- 12 PCS



16MM x 2MM- 12 PCS



M8- Key- 1 PC

### Step 1

Insert the wooden back legs into the back rest. Attach the wooden back legs to the back rest frame using 2 of the supplied threaded bolts and washers. Start with one side, then the opposite. Tighten using supplied allen key.

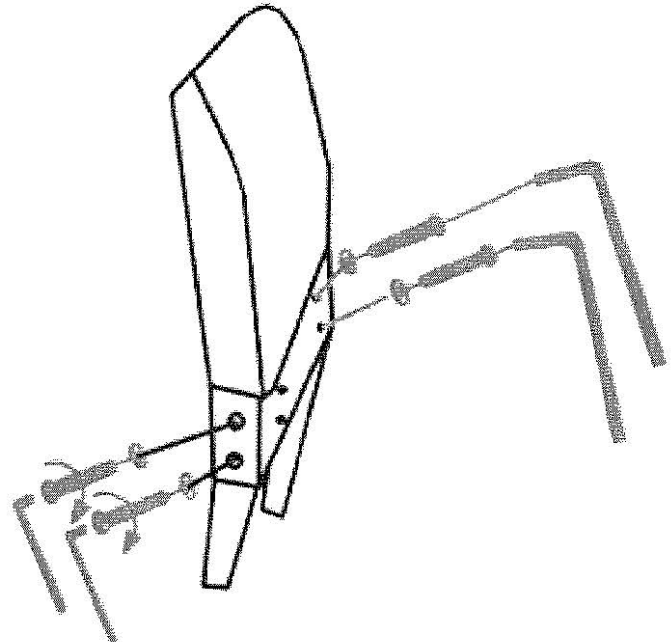
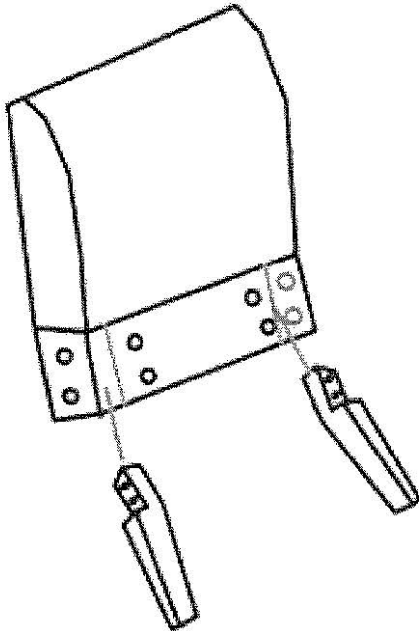

## Assembly Instructions

### Step 2 Attach Backrest to seat frame using 4 of the supplied threaded bolts and washers

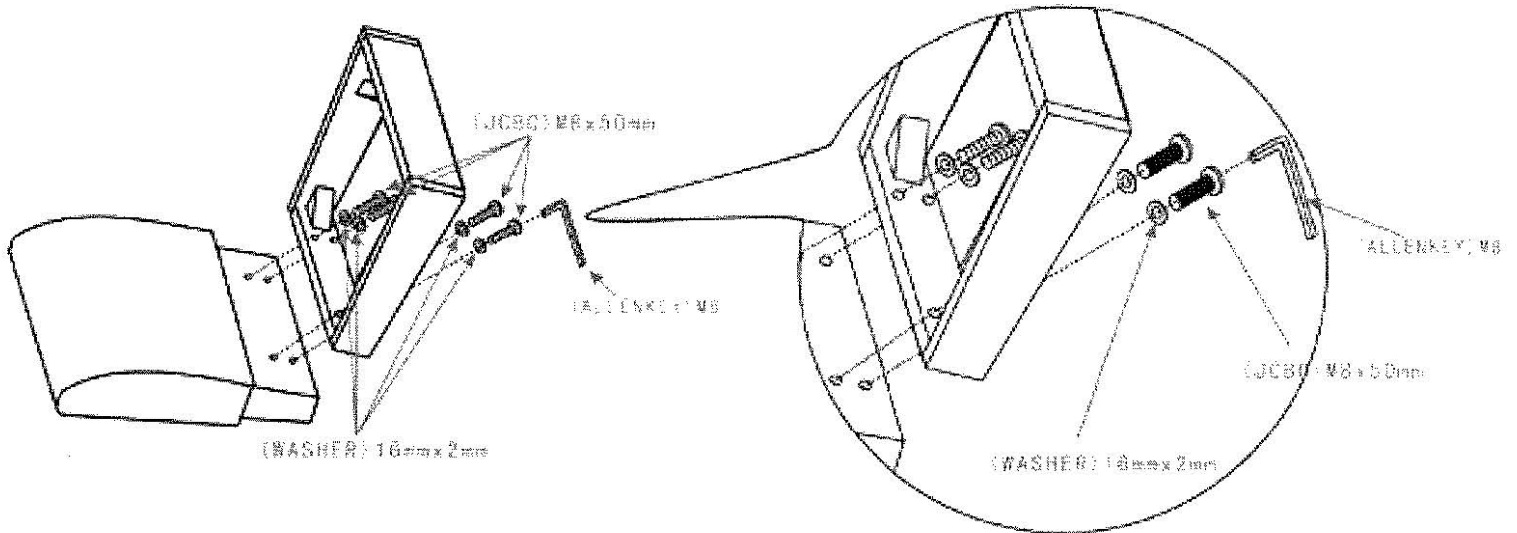

### Step 3 Place the Chair Frame Upside down. Insert the wood front legs into the cavity located in the front of the seat base frame. Insert the provided threaded bolts into the pre threaded nuts in each leg. Tightened using the allen key supplied

