

# INSTALLATION INSTRUCTIONS

CARE AND USE MANUAL FOR:

## Ceiling Hood



Models covered by this instructions:  
**SUT950 – SUT951 – SUT958**

\*\*\* BEFORE INSTALLATION \*\*\*

ENSURE THERE IS NO VISIBLE OR HIDDEN DAMAGE SUSTAINED  
DURING SHIPPING

\*\*\* SHIPPING DAMAGE \*\*\*

MUST BE REPORTED WITHIN 5 DAYS OF RECEIPT



**Sirius**

# WARNING

---

*Thank you for purchasing a Sirius Range Hood.  
Please read all the instructions in this manual before  
installing the appliance.*

*Save these instructions for future reference.*

Only use this appliance as an exhaust ventilation system for the removal of cooking vapors. **DO NOT** use to expel flammable substances or any other materials or vapors.

The installation procedures in this manual are intended for qualified installers, service technicians or persons with similar qualified background. **DO NOT** attempt to install this appliance yourself.

Ensure that electrical power is turned off at source before commencing installation. All electrical wiring must be properly installed, insulated and grounded and conform to all applicable codes and standards.

Make sure all existing duct work is clean of grease build up, or duct work should be replaced, if necessary, to avoid the possibility of a grease fire. Check all joints on ductwork to ensure proper connection and all joints should be properly taped. Be careful when cutting through ceilings or walls not to damage any hidden pipes or electrical wiring. Ensure your kitchen has sufficient air return vents to replace the exhausted air.

Fan ducts should always be vented to the outside of your home and never into spaces within walls, ceilings, lofts or attics. Only use rigid, smooth steel for ducting. The exhaust point of the blower requires a 6" or 8" round connection.

# TABLE OF CONTENTS

BEFORE YOU BEGIN	4
DUCTING	4
ELECTRICAL	5
Electrical Supply	5
INSTALLATION	6
Before the installation	6
Panels opening	6
Installation	6
OPERATING PROCEDURES	8
General Advice	8
Technical data	9
Standard configuration	9
Generating a new transmission code	9
Learning the new transmission code	9
MAINTENANCE	10
Cleaning the Filter	10
Cleaning the Hood	10
WARRANTY	12

# BEFORE YOU BEGIN

The manufacturer declines all responsibility in the event of failure to observe the instructions given here for installation, maintenance and suitable operation of the product. The manufacturer further declines all responsibility for injury due to negligence and the warranty of the unit automatically expires due to improper maintenance and/or installation.

**BEFORE YOU BEGIN: It is advisable to test run the range hood before installation.**

**BEFORE STARTING** – please read this entire document and ensure you are fully conversant with the requirements and limitations. These units weigh approximately 125lbs and therefore require a minimum of two people to install.

Recommended height from cook top to underside of hood = 30" for gas, 25" for electric.

# DUCTING

If vented externally, 6" / 150mm round ducting must be available for the hood through the ceiling, in line with the central vertical axis of the range hood.

**If it's gas range or cook top recommended 8".**

This unit must have its own ductwork. Do not under any circumstances vent this unit into any other ductwork or exhaust ducting in the building.

Furthermore, please read carefully all of the following installation instructions.

- Use an exhausting pipe whose maximum length does not exceed 5 meters.
- Limit the no. of elbows in the piping, since each elbow reduces the air capacity of 1 linear meter. (Ex.: if you use no. 2 x 90 ° elbows, the length of piping must not exceed 3 meters).
- Avoid abrupt direction changes.
- Use a 6"/8" mm constant diameter pipe for the whole length.
- Use piping approved by standards in force.

Use the shortest most direct ductwork route possible. Only use metal ducting – plastic ducting is generally not permitted by code. Do not use flexible metal ducting as the ridges of the ducting cause severe air turbulence and will significantly reduce the efficiency of any hood –THIS TYPE OF DUCTING WILL REDUCE EFFICIENCY BY 50%.

Vent hoods may interrupt the proper flow of exhaust gases from fire-places, gas furnaces and gas water heaters. To minimize the risk of drawing these lethal gases back into the home please follow the heating equipment manufacturers safety standards and guidelines. Refer to NFPA and ASHRAE for additional information.

# ELECTRICAL

**WARNING: All electrical work must be performed by a qualified electrician.**

Please ensure that the appropriate electrical codes or prevailing local building codes and ordinances are adhered to.

Ensure that the electricity supply is disconnected at source. Do not use an extension cord or adapter plug with this appliance.

This appliance must be grounded. Connect to a properly grounded branch circuit, protected by a 15 amp circuit breaker.

## **Electrical Supply.**

This appliance requires 120V/60Hz, 3amp electrical supply - ensure an appropriately qualified person completes the electrical hook-up. The connection point for the electrical supply is at the top of the unit, therefore the electrical supply must be run down from the ceiling alongside the ductwork.

All electrical and venting hook-ups must be in place before commencing installation of the hood-fan.

# INSTALLATION

## BEFORE THE INSTALLATION

This models can be used only if connected with external motors produced by the same manufacturer.

## PANELS OPENING

It is possible to open the steel panels, which cover the grease filters, by slightly pulling on a side of the panel itself, as shown in Fig. 1.

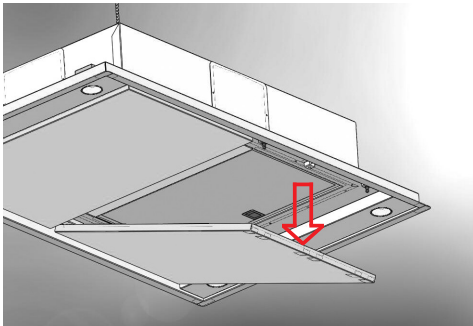

To achieve the complete opening of panels, you need to release the safety chains, by using the appropriate spring catches.

For proper working, it is recommended to install the appliance at a distance of **83"** from the floor.

Before starting the appliance installation, please check that all components are not damaged, in such a case contact your retailer and do not carry out installation.

## INSTALLATION

Fit a false ceiling with an opening that has the following dimensions:

**SUT950: 57" 43/64 x 37" 63/64**

distance of **12"** between the ceiling and the false ceiling;

**SUT951: 41" 59/64 x 26" 12/64**

**SUT958: 34" 4/64 x 15" 60/64**

distance of **12"** between the ceiling and the false ceiling.

After having chosen the most suitable position, prepare the ducting: an air outlet connection piece, with a diameter of **6"** to be installed in the side selected, is provided with the appliance.

Leave any unused exhaust outlets closed. As shown in fig.2.

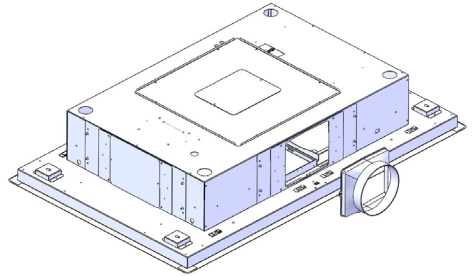

Draw the outline of the hole to house the ceiling-mounted hood on the solid ceiling as shown in Fig. 3 according to the model chosen.

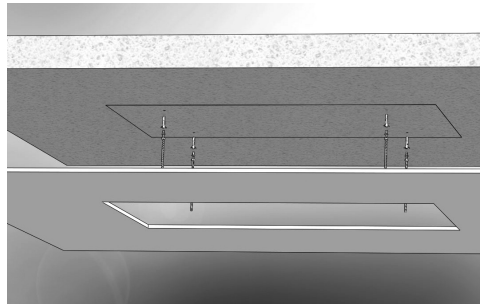

Make 4 holes in the ceiling according to the dimensions as shown in Fig. 4, place the metric plugs provided in the holes.

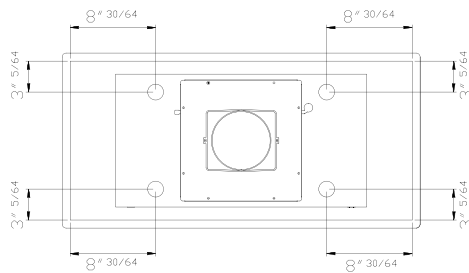
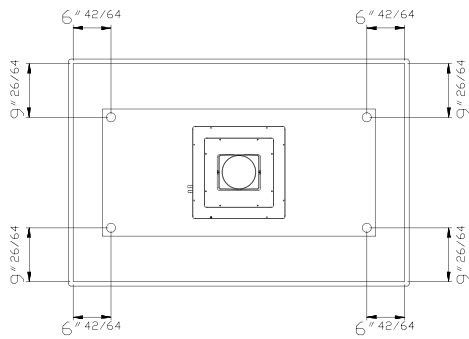
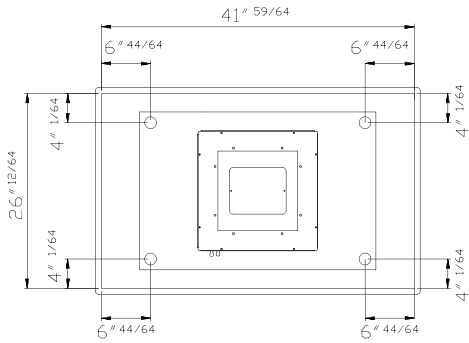

Open the stainless steel panels and remove the grease filters in order to avoid damaging them in any way and too allow installation; screw the threaded bars provided into the plugs as shown in fig.5.

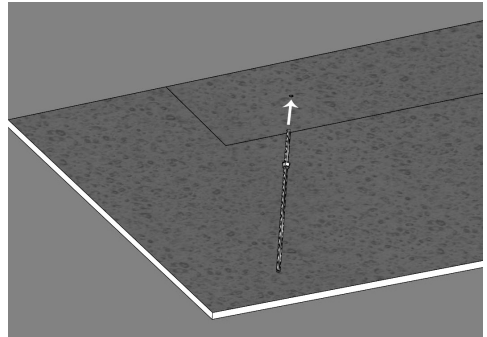

The threaded bars are  $9'' \frac{27}{32}$  long and serve to install the ceiling-mounted hood at a distance from the solid ceiling of between  $10'' \frac{40}{64}$  and  $14'' \frac{9}{16}$  as shown in fig. 6.

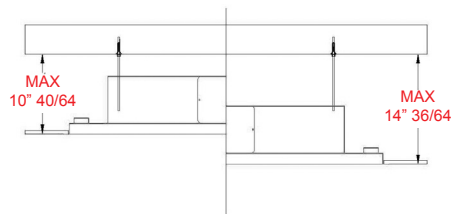

in case of a larger gap between the hood and the ceiling, you need to use longer threaded bars.

Connect the power supply into the metal box placed inside the hood as shown in fig. 7.

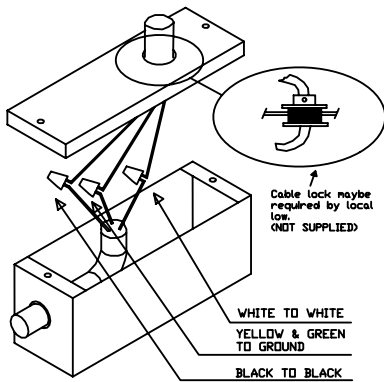
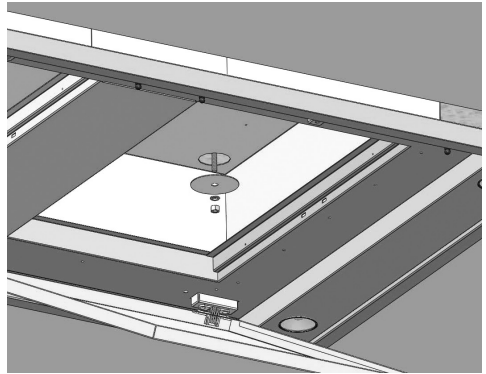
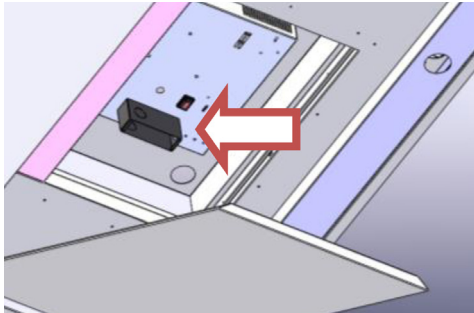

and connect the air outlet pipe.  
Do not fix the ducting to the outlet with screws – use DUCT TAPE;  
place the ceiling-mounted hood into the niche, the outer edge of the hood needs to be perfectly flush with the false ceiling. Insert the plates and nuts provided on the threaded bars, making sure to tighten them securely, as shown in Fig. 8; refit the grease filters and filter cover panels.

# OPERATING PROCEDURES

Read all the instructions before operating the appliance. Save these instructions for future reference.

## **General Advice.**

Ensure that the grease filters are in place. Without these components, operating blowers could catch on to hair, fingers and loose clothing. Keep fan, filters and surfaces clean of grease and fat. Always turn hood fan ON when cooking. NEVER leave cooking unattended.

NEVER dispose cigarette ashes, ignitable substances or any foreign objects into blowers.

Cooking that generates flame is not recommended as this hood is equipped with a thermal overload that will shut down the motor if it senses excessive heat.

When frying, oil in the pan can easily overheat and ignite. Heat oil slowly in an appropriately sized pot (covering the entire burner) to reduce the risk of boiling over and burning.

In the event of a range top grease fire, observe the following:

Switch OFF the range hood. Turn off the cook top then smother flames with a close fitting lid, cookie sheet or other metal tray. If the flames do not go out immediately.

**EVACUATE AND CALL THE FIRE DEPARTMENT.**

Never pick up a flaming pan – you may be burned. DO NOT USE WATER including wet dishcloths or towels, as a violent steam explosion may occur.

## SUT950 – SUT951 – SUT958

### RC001

#### RADIO CONTROL





Radio control used for the remote operation of ducted cooker hoods.

#### TECHNICAL DATA

- Alkaline battery powered: 12 V mod. 23 A
- Operating frequency: 433.92 Mhz
- Combinations: 32.768
- Max. consumption: 25 mA
- Operating temperature: -20 ÷ + 55 °C
- Dimensions: 120 x 45 x 15 mm.

#### OPERATING DESCRIPTION

The transmitter is equipped with 5 buttons for cooker hood management, as specified below:

-  : Light ON/OFF command.
-  : Motor ON (speed level 1) / OFF command.
-  : Reduce speed.
-  : Increase speed.
-  : 10-minute timer.

#### INITIAL OPERATING CONDITION

The manufacturer supplies the radio control unit ready to be used with codes preset in the Factory



#### OPERATION MODE

##### Standard configuration:

Standard configuration requires all “cooker hoods – radio control – system” to be provided with the same transmission code. In the event two cooker hoods – radio control system are installed in the same room or nearby, each system may affect the operation of the another. Therefore, the code of one radio control system must be changed.

#### Generatiing a new transmissiion code:

The radio control system is provided with preset codes. Should new codes be required, proceed as follows: Press simultaneously buttons:



for two seconds. When Leds light on, press buttons:

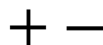

(within 5 seconds). Leds flashing 3 times indicate the procedure is completed.

**WARNING! This operation deletes permanently the preset codes.**

#### Learniiing the new transmissiion code:

Once the transmission code is changed in the radio control unit, the electronic central unit of the cooker hood must be made to set the new code in the following way: Press the main power-off button of the hood and then restore power to the electronic control unit. Within the next 15 seconds, press the Light Button  to synchronise the central unit with the code.

#### Reset of the Factory configuration:

To restore the Factory configuration, follow the procedure described below: press simultaneously buttons:



for 2 seconds. When Leds light on, press buttons:

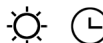

(within 5 seconds). Leds flashing 6 times indicate the procedure is completed.

**WARNING! This operation deletes permanently the preset codes.**

Emergency button:

In the event that the radio control does not work, use the emergency button to switch the appliance off. After any necessary repairs have been performed, reset the emergency button.

**WARNIING**

The battery should be replaced every year to guarantee the optimal range of the transmitter.

To replace the exhausted battery, take the plastic lid off, remove the battery and replace it with a new one, observing the correct battery polarities.

Used batteries should be discarded in special collection bins.

The below product:

RC001 Radiio Controll

complies with the specifications set out in the R&TTE Directive 99/5/EC.

**WARNING**

Any adjustments or modifications which have not been expressly approved by the holder of the legal conformity certificate may invalidate the user's rights relating to the operation of the device.

The products are endowed with an electronic device which allows the automatic switching off after 4 hours working from the last operation.

**Warning The battery should be replaced every year to guarantee the optimal range of the transmitter. To replace the exhausted battery, take the plastic lid off, remove the battery and replace it with a new one, observing the correct battery polarities. Used batteries should be discarded in special collection bins. ??????????**

**QUALE SAREBBE QUELLO NUOVO?????**

Filter requires washing indicator: after 30 hours of use, all the buttons will light up to remind you that the grease filter should be cleaned. Follow the instructions for cleaning filters in this booklet. Once the grease filters have been cleaned and replaced, reset by pressing the timer button (F). Do not rely solely on this indicator. Generally, the grease filter should be washed on a regular basis to avoid grease filter fires.

The blower should be turned on for approximately 5 minutes before cooking in order to establish air currents upward through the hood. Use the low speeds for normal use and the higher speeds for strong odors and fumes.

## MAINTENANCE

The hood-fan should provide many years of trouble free service provided it is maintained properly.

### **Cleaning the Filter.**

Clean the grease filter either by carefully hand washing, (so as not to damage the filter design) or, preferably in a dishwasher. Depending on use, the filters should be cleaned at least every two weeks in a dishwasher.

If a carbon filter has been fitted this must be replaced at least every 6 months as a minimum. Depending on cooking style and nature of cooking (greasy foods, fry's, curries etc) would probably require more frequent replacement - if odors start to manifest themselves when cooking it is time to replace the carbon filter. We suggest you retain a spare set. These can be ordered from the supplier of your range hood.

### **Cleaning the Hood.**

Cleaning of the internal parts should be done with a clean damp (not excessively wet) cloth together with regular household detergent. The external stainless steel elements should be cleaned with a good quality foaming stainless steel cleaner. Read the manufacturers directions. Generally they recommend that the foam be sprayed onto a clean dry cloth and then applied to the stainless steel. Allow the foam to react on the surface for a few minutes and then wipe with a clean dry cloth.

On the surfaces that are exposed directly to heat from the cook-top, it is advisable to clean these on a regular basis to avoid the marks from becoming baked on.

Do not under any circumstances use an abrasive type cleaner as this will scratch and damage the stainless steel finish. Glass components should be cleaned with a product such as Windex.

## FOR SUT950 – SUT951

Turn blower and lights off. Make sure the lights are cool.

If new lights do not operate, check fuses and be sure globes and breakers are inserted correctly.

**Do not remove** the entire fixture (socket) as this is very difficult to reinstall. Gently pry the bulb from the fixture using a soft instrument such as a toothpick. Steel instruments will scratch the surface (refer to figure 5).

Replace the appropriate bulb. Check parts brochure or specification sheets on our website. Wipe both sides of the glass whilst it is out. Re-insert the glass-blocking ring and fasten it.

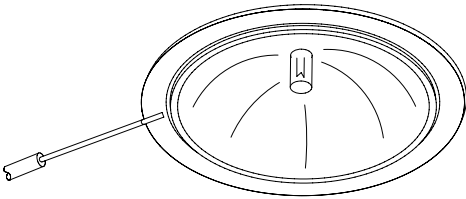

fig. 5

### Substitution of the LED bar:

Using an appropriate tool, remove the LED bar from its seat (refer to Fig. 6), disconnect it electronically using the appropriate connector then substitute it with a LED bar with same characteristics.

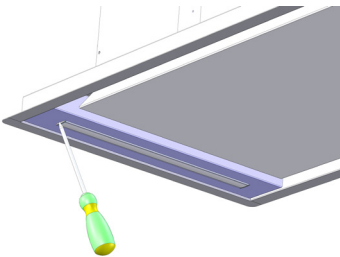

fig. 6

# Sirius

## Three Year Limited Warranty

YOU MUST REGISTER THE PURCHASE OF YOUR PRODUCT ON LINE AT [www.siriuscappe.com/usa/warranty.htm](http://www.siriuscappe.com/usa/warranty.htm) TO CONVALIDATE YOUR WARRANTY.

YOU CAN FIND THE DATA OF YOUR HOODS ON A LABEL INSIDE THE HOOD. JUST REMOVE THE GREASE FILTER TO READ IT.

### WARRANTY SERVICE

To qualify for warranty service, you must notify Sirius After sale service at the email address stated below or call toll free USA 1-877-474-8770 and provide the model number, description of the fault or defect and original date of purchase. Sirius reserves the right to request proof of original purchase. Sirius will at its sole option and discretion replace products that arrive damaged through shipping, provided shipping damage is reported as stated above WITHIN 5 BUSINESS DAYS OF RECEIPT of the shipped product or products.

#### ONE YEAR SERVICE REPAIR WARRANTY:

During the first year from date of original purchase, Sirius will, at its option, repair or replace, without charge, any product or part which is found to be defective under normal use and service.

#### THREE YEAR PARTS WARRANTY:

For three years from date of purchase, Sirius will provide free of charge, non-consumable replacement parts which are found to be defective under normal use and service.

#### WHO IS COVERED:

Sirius warrants to the original consumer purchaser of its products that such products will be free from defects in materials and workmanship for a period of three years from the original date of purchase. There are no other warranties, express or implied, including, but not limited to, implied warranties of merchantability or fitness for a particular purpose or application.

#### WHAT IS NOT COVERED:

This warranty does not extend to filters, lamps, batteries, ducts and ductwork components. This warranty does not cover normal maintenance and service or products or parts which have been subject to misuse, negligence, accident, improper maintenance or repair, faulty installation or installation contrary to recommended installation instructions. The warranty on glass screens is limited to manufacturing defects only and expressly excludes cracks and breakages as a result of faulty installation. *Labor and associated costs associated directly with removal and re-installation are expressly excluded.*

The duration of any implied warranty is limited to the three year period as specified for the express warranty. Some states and provinces do not allow limitation on how long an implied warranty lasts, so the above limitation may not apply to you.

#### Sirius S.P.A.

Zona industriale Berbentina 6/A  
60041 SASSOFERRATO (AN)  
ITALY

#### Sirius after sale service

Telephone (toll free): 1-877-474-8770  
Email: [Sirius@adcoservice.com](mailto:Sirius@adcoservice.com)

Register Online! [www.siriuscappe.com/usa/warranty.htm](http://www.siriuscappe.com/usa/warranty.htm)