

Assembly Instruction

Accent Cabinet

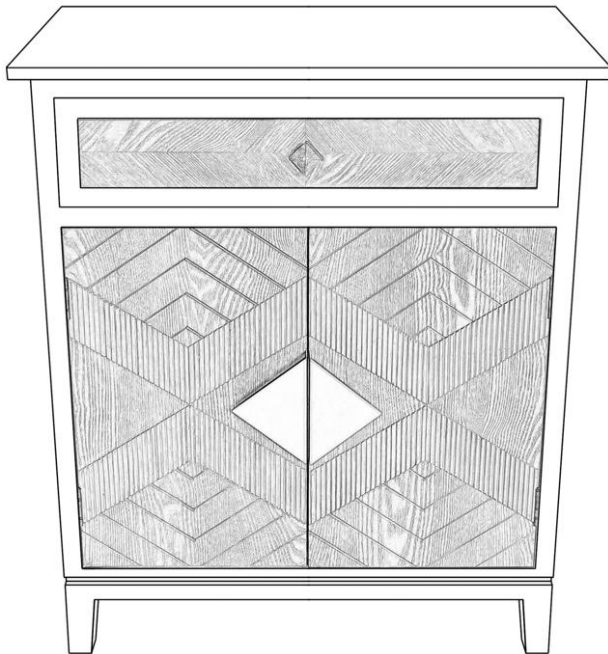





Assembly Instruction





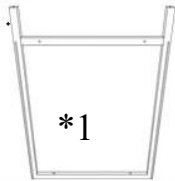
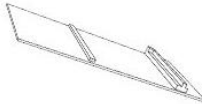
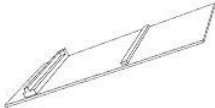



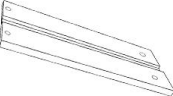
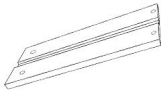
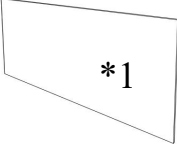
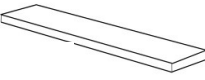



⚠ WARNING:

- Read all instructions carefully and completely before assembly and use.
- Retain for future reference.
- **DO NOT use power tools.**
- **DO NOT over-tighten hardware.**
- Periodically check all hardware and re-tighten as necessary.
- DO NOT use product if any component becomes damaged.
- For residential (non-commercial) use only.
- DO NOT sit or stand on product. Use only for intended purpose.
- DO NOT exceed 80lbs for the tabletop and 30lbs for the shelf, evenly distributed.

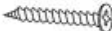
Parts List

Check all parts before assembly

<p>A. <u>Table top</u></p>  <p style="text-align: center;">*1</p>	<p>B. <u>Back panel</u></p>  <p style="text-align: center;">*1</p>	<p>C. <u>Side Panel</u></p>  <p style="text-align: center;">*1</p>	<p>D. <u>Side Panel</u></p>  <p style="text-align: center;">*1</p>
<p>E. <u>Front Panel</u></p> 	<p>F. <u>Bottom Panel</u></p>  <p style="text-align: center;">*1</p>	<p>G. <u>Shelf</u></p>  <p style="text-align: center;">*1</p>	<p>H. <u>Drawer front</u></p>  <p style="text-align: center;">*1</p>
<p>I. <u>Drawer left panel</u></p>  <p style="text-align: center;">*1</p>	<p>J. <u>Drawer right panel</u></p>  <p style="text-align: center;">*1</p>	<p>K. <u>Drawer bottom</u></p>  <p style="text-align: center;">*1</p>	<p>L. <u>Drawer back panel</u></p>  <p style="text-align: center;">*1</p>

<p>H1.Hex bolt</p>  <p>*8(+1 extra)</p>	<p>H2. Washer</p>  <p>*8 (+1 extra)</p>	<p>H3. Screw(short)</p>  <p>*2(+1 extra)</p>	<p>H4. Drawer stop</p>  <p>*2</p>
<p><u>H5. Bolt</u></p>  <p>*4 (+1 extra)</p>	<p>H6. Screw</p>  <p>*4 (+1 extra)</p>	<p>H7. Screw (long)</p>  <p>*4(+1 extra)</p>	<p>H8. Foot pad</p>  <p>*4</p>
<p>H9. Allen Key</p>  <p>*1</p>	<p>H10. Spanner</p>  <p>*1</p>	<p>H11. Knob</p>  <p>*1</p>	<p>H12. Bolt</p>  <p>*2(+1 extra)</p>
<p>H13. Shelf pin</p>  <p>*4</p>			

Step 1:Put the Tabletop (A) on a soft surface to protect the finish.
 Attach Back panel (B) to the Top (A) with Hex bolts (H1) and Washers (H2)
 using Allen key (H9). Ensure the Back panel (B) aligned with the groove on
 Top(A). **Leave hardware loose in this step.**

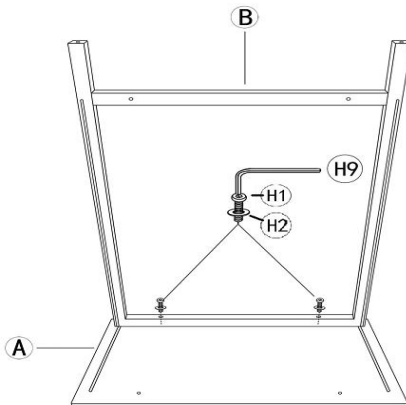

Step 2: Insert the Side panels (C&D) as shown below. Ensure the side panel (C&D) aligned with Groove on the Back panel (B).

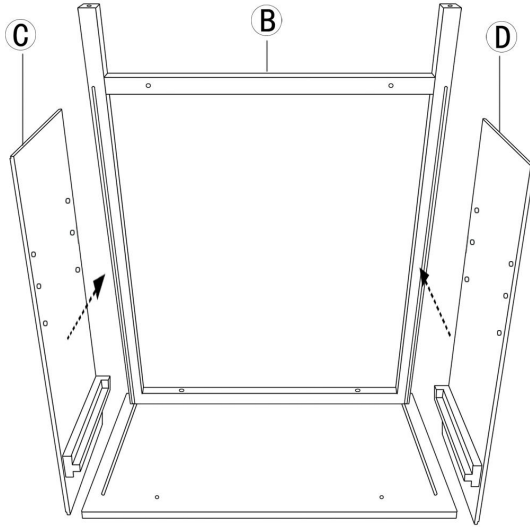

Step 3: Attach the Front panel (E) with Hex bolts (H1) and Washers (H2) by Allen key (H9) as shown in picture below. **Leave hardware loose in this step.**

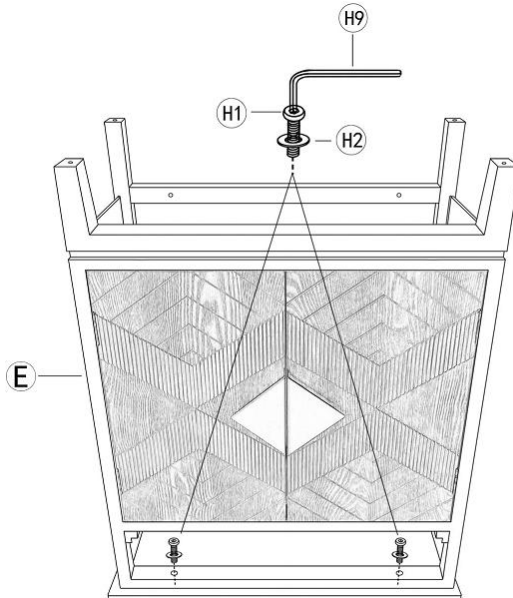

Step 4: Attach the Bottom panel (F) with Hex bolts (H1) and Washers (H2) by Allen key (H9) as shown in picture below. Note doorstop on E faces toward open front. **Fully tighten all bolts from Step 1 to 4.**

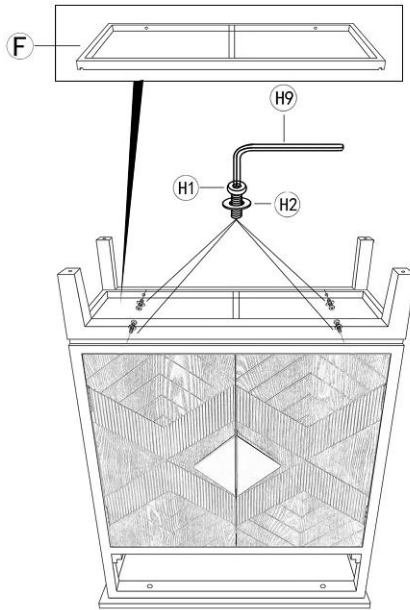

Step 5: Attach the Foot pads (H8) to the bottom of all Legs as shown.

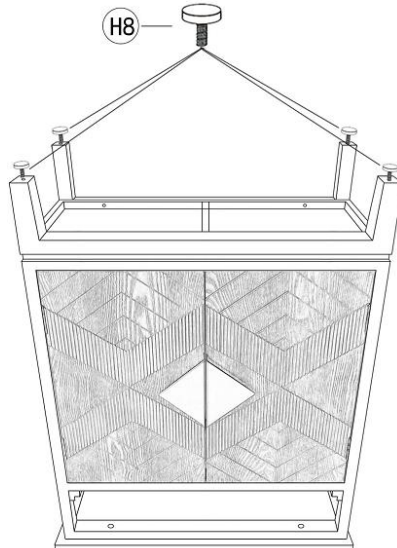

Step 6: Place the Drawer front (H) on soft surface to protect the finish.

1. Attach the Drawer left&right panel (I&J) on the Drawer front (H) with Bolt (H5)&screw(H6) by Spanner (H10) as below shown.

2. Insert the Drawer bottom panel (K) to the left&right panel (I&J) as shown.

3. Attach the Drawer stop (H4) on the Drawer Side panel (I&J) with Screw(H3) by Spanner (H10) as below.

4. Attach the Drawer Back Panel (L) with Screw (H7) by Spanner (H10)

5. Attach the Knob (H11) to the Drawer front (H) with bolt (H12) by Spanner (H10) as below. Place the Drawers into the Body.

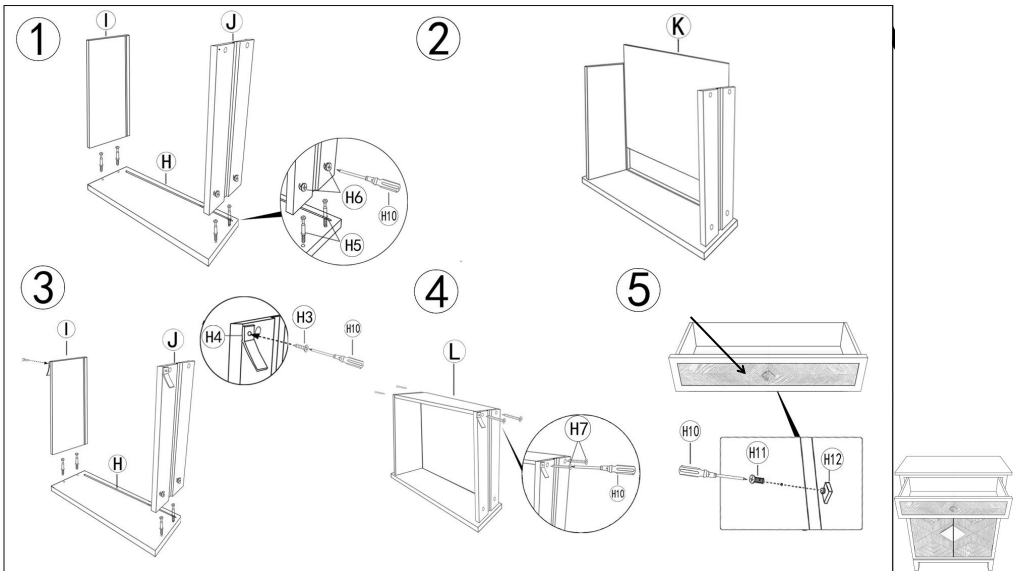

Step 7: Open the doors, insert the Metal tab (H6) into the holes. Place the Shelf (F) inside as shown in picture below. (Each side panel with 6 adjustable holes.)

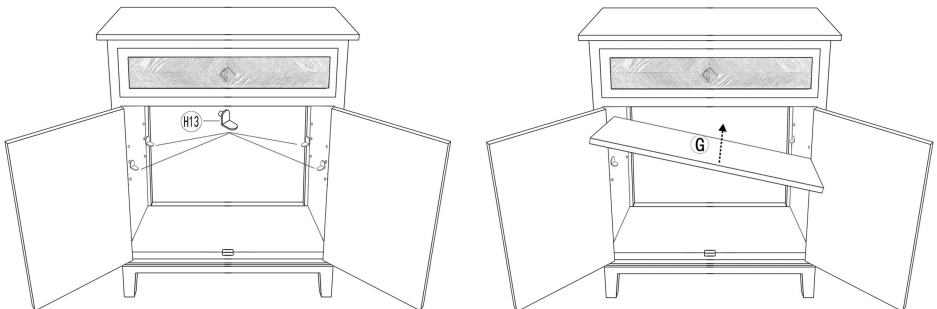

Assembly finished.

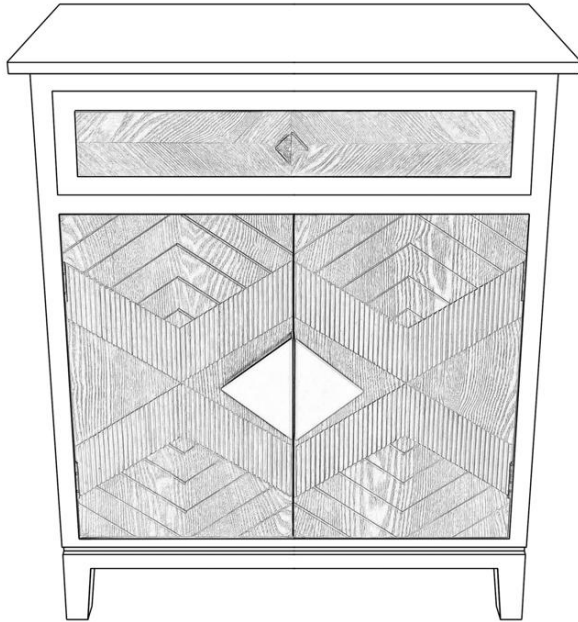

Notice:

If you encounter any issues during installation or use, please email us at support@mi-din.com, including your order ID and a detailed description of the problem. If possible, please provide relevant images to expedite assistance. We will strive to resolve any issues promptly.