

Pure & Easy



ASSEMBLY INSTRUCTIONS



NOTICE

IMPORTANT, RETAIN FOR FUTURE REFERENCE: READ CAREFULLY
WICHTIG, FÜR SPÄTERE NACHSCHLAGE AUFBEWAHREN: SORGFÄLTIG LESEN
IMPORTANTE, GUARDAR PARA REFERENCIA FUTURA: LEER ATENTAMENTE
IMPORTANTE, CONSERVARE PER RIFERIMENTI FUTURI: LEGGERE ATTENTAMENTE
IMPORTANT, À CONSERVER POUR RÉFÉRENCE FUTURE : LIRE ATTENTIVEMENT

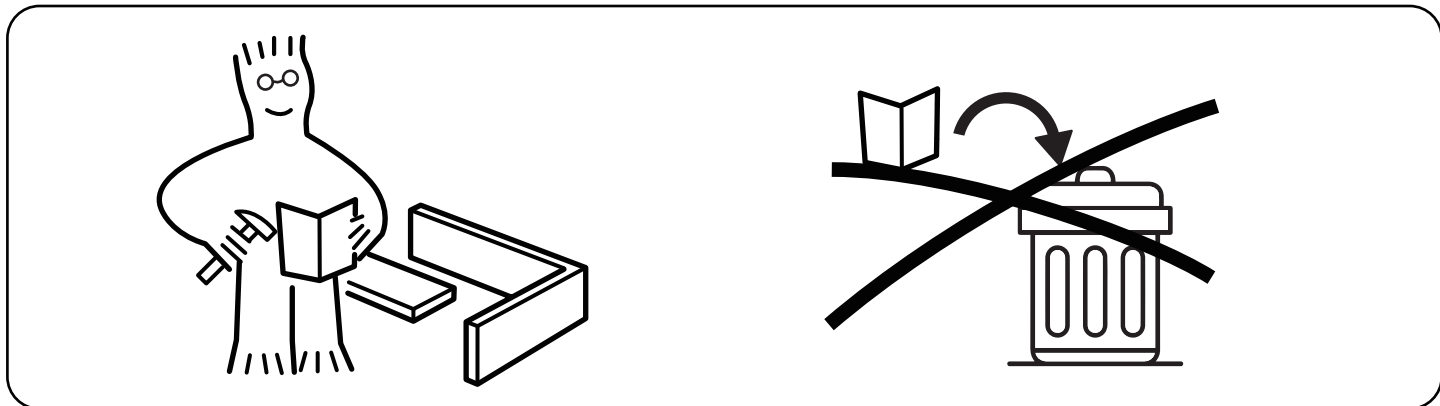

Assemble on a flat and solid surface. To avoid the unstable surface affecting the overall frame stability during installation.

Montieren Sie auf einer ebenen und festen Oberfläche. Um zu verhindern, dass eine unebene Oberfläche während der Montage die Gesamtrahmen-Stabilität beeinträchtigt.

Ensamblar en una superficie plana y sólida. Afin d'éviter que la surface inégale n'affecte la stabilité générale du cadre lors de l'installation.

Assemblare su una superficie piana e solida. Per evitare che una superficie irregolare influisca sulla stabilità complessiva della struttura durante l'installazione.

Assembler sur une surface plate et solide. Para evitar que la instalación en una superficie irregular afecte la estabilidad general del marco.

Professional installation is highly recommended.

Eine professionelle Installation wird dringend empfohlen.

Une installation professionnelle est fortement recommandée.

Si raccomanda vivamente l'installazione professionale.

Se recomienda altamente la instalación profesional.



Periodically Check That All Components Are Tightly Secured.

Überprüfen Sie Regelmäßig, Dass Alle Komponenten Fest Gesichert Sind.

Vérifiez Périodiquement Que Tous Les Composants Sont Bien Fixés.

Controllare Periodicamente Che Tutti I Componenti Siano Ben Fissati.



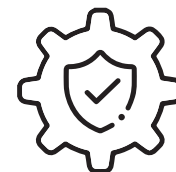

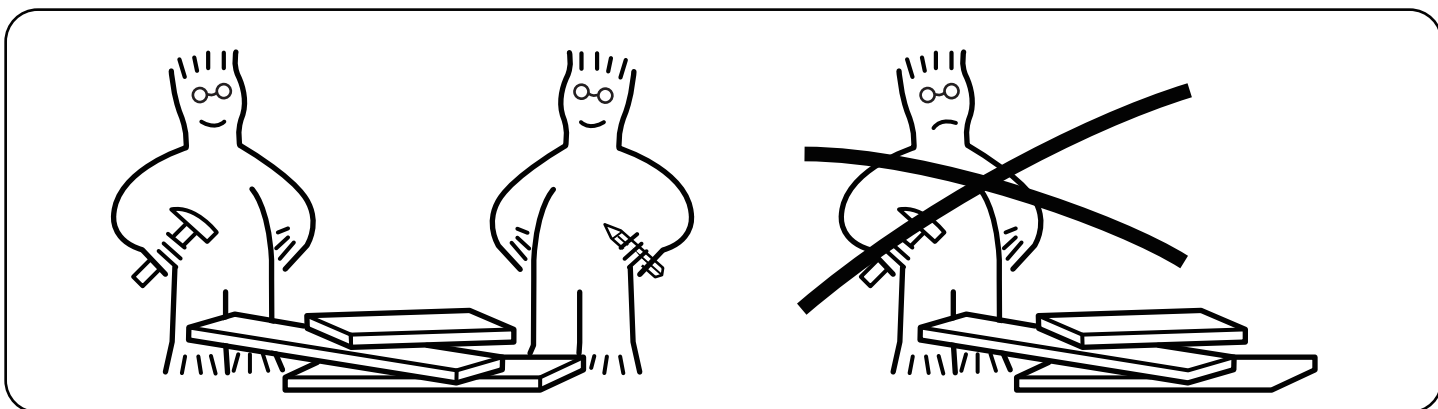

Verifique Periódicamente Que Todos Los Componentes Estén Bien Asegurados.



It is recommended that multiple people assemble this product.
 Es wird empfohlen, dass mehrere Personen dieses Produkt zusammenbauen.
 Il est recommandé que plusieurs personnes assemblent ce produit.
 Si raccomanda che più persone assemblino questo prodotto.
 Se recomienda que varias personas ensamblen este producto.

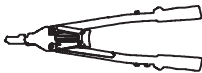

Please have the following auxiliary tools ready:

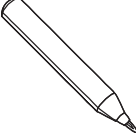
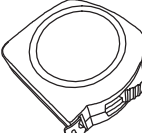
Tools					
	Gloves	Safety Glasses	Shoes	Riveting Gun	Ladder
					
	Power drill	Screw driver	Pencil	Tape Measure	

This metal shed might not be suitable for local bylaws or weather conditions. It is the owner's responsibility to ensure the installation and use of this building are permitted by local authorities. Some municipalities may require engineering drawings to be submitted. It is the owner's responsibility to hire an engineer to submit drawings if required.

Watch the Weather:

Ensure the day you choose to install your building is dry and calm. Do not attempt to assemble your building on a windy day. Be cautious on wet or muddy ground.

Selecting and Preparing Your Site: Before assembly, choose a location for your building. The ideal spot is a level area with good drainage.

Make sure there's enough working space to easily move parts into position during assembly. Ensure there's sufficient space at the entrance for doors to open fully, and ample room around the building to fasten the panel screws from the outside.

Before starting assembly, construct a base and have an anchoring system ready.

OPTION 1: WOOD PLATFORM

Determine the size: measure the size of the bottom of the tin tool room, the base should be bigger than the tool room.

Prepare materials: Prepare lumber, screws, nails, saws, drilling tools, etc.

Build the frame: Use lumber to make a rectangular frame that is slightly larger than the tool house.

Reinforce the frame: Add support strips to the corners and center of the frame.

Make panels: cut planks of wood to cover the frame and secure them.

Checking the level: Make sure the base is perfectly level.

Waterproofing: Waterproof the wood, e.g. by applying waterproof paint.

Install the base: Place the base in the intended position and then install the shed.

OPTION 2: CONCRETE SLAB

Design Confirmation: Determine plinth dimensions and material requirements.

Site Preparation: Clear and level the plinth area.

Bedding construction: lay gravel bedding on the base.

Formwork erection: Erect the formwork according to the design.

Reinforcing steel tying: Lay out the reinforcing steel in the formwork.

Concrete Pouring: Pour and vibrate the concrete.

Curing: Keep the concrete moist to promote curing.

Tips:

1. Clear a working area to allow access on 4 sides. A raised work surface will make assembly easier.
2. All parts are identified so when working through the instructions page by page the diagrams show where each part is positioned.
3. Some of the holes have been pre-punched, to allow fixing using self-tapping screws or rivets, where additional holes are required a drill bit is included.
4. Before starting, to avoid any accidental injury, we recommend the use of gloves to protect your hands, safety glasses to protect your eyes and shoes or boots to protect your feet.
5. Please keep children away from your construction site.
6. Most assembly can be completed by one person, assistance may be needed when you reach the erection stage.
7. Please note: Some local government authorities have rules & regulations on shed installation and you may need approval to erect this shed.











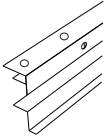

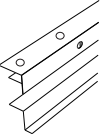

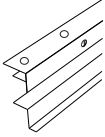

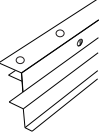
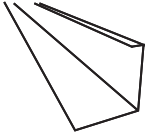
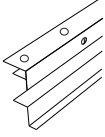
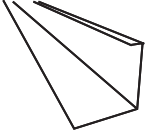
Steps:

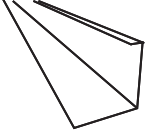

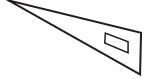

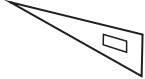

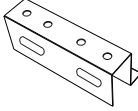

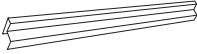

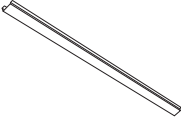
1. Unpack all components from the carton and lay outside your work area and check parts against the part list on the next page.
2. Work through assembly instructions Page by Page
3. When completed place shed in position and anchor securely to the ground.
4. Clean up all metal pieces, rivets and screws.

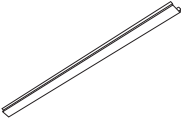
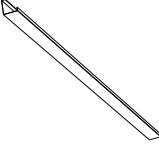
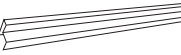
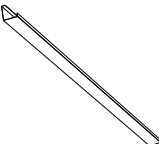
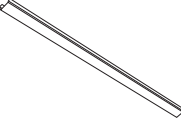
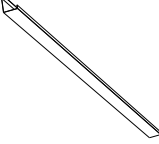
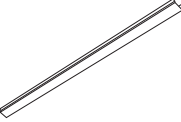
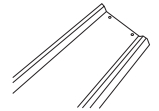
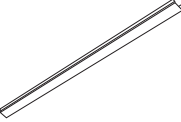

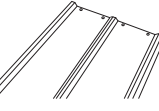

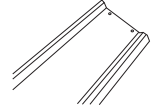

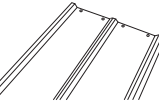

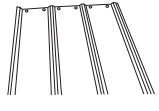

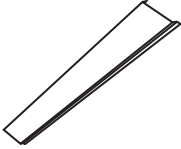
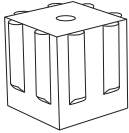
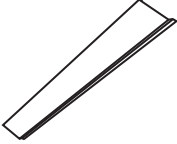
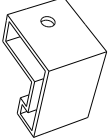
Practice caution with the tools being used in the assembly of this building. Be familiar with the operation of all power tools.

Never concentrate your total weight on the roof of the building. When using a step ladder, make sure that it is fully open and on even ground before climbing on it.

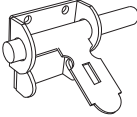
PARTS

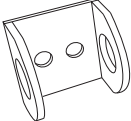
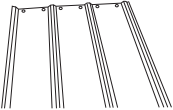
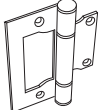
Item no.	Reference Image	Qty.	Item no.	Reference Image	Qty.
1L		X1	5F		X21
1R		X1	6L		X2
2		X2	6R		X2
3L		X1	7B		X2
3R		X1	7F		X2
4		X1	8		X2
4L		X1	9		X1
4R		X1	10		X1
4A		X1	20		X2
5B		X1	21		X2

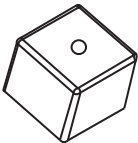
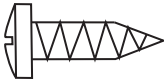
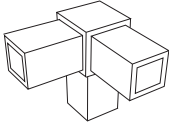
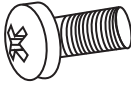
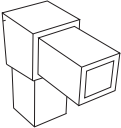
Item no.	Reference Image	Qty.	Item no.	Reference Image	Qty.
22		X1	34		X2
23		X1	35		X1
24		X4	36		X1
25		X2	37		X2
26		X1	Q1		X5
27		X1	Q2		X3
28		X4	Q3		X6
29		X2	D1		X2
32		X2	D2		X4
33		X2	D3		X1

Item no.	Reference Image	Qty.	Item no.	Reference Image	Qty.
K1		X1	F		X6
K2		X1	J		X2
K3		X1	P1		X2
K4		X1	P2		X2
M1		X4	P3		X2
M2		X1	P4		X6
B		X2	I		X5
C		X4	S1	 ST4*10mm	X200
E		X2	S2	 M4*10mm	X134
G		X2	S3		X166

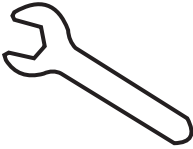
Item no.	Reference Image	Qty.
S4		X134
—		X1

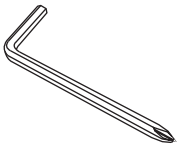
Item no.	Reference Image	Qty.
—		X1

Parts and Parts List:

Before proceeding with assembly, please check to ensure you have all the necessary parts for your building. If any parts are missing, do not attempt to assemble the building, as partially assembled structures may be severely damaged in light wind. If you find any parts missing, please contact us immediately.

EXPLODED VIEW

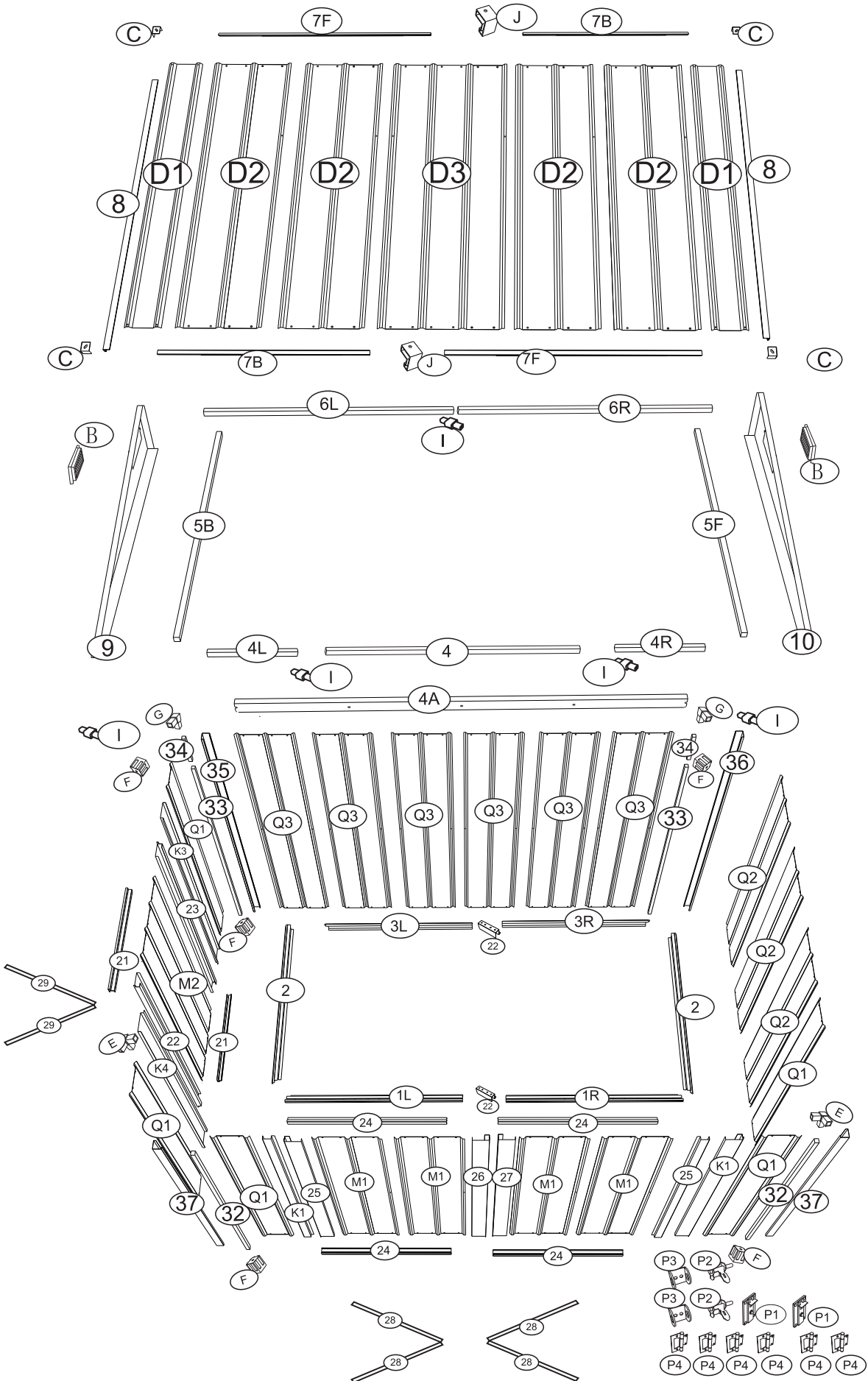

ASSEMBLY

1



①L 1pc



①R 1pc



③L 1pc



③R 1pc

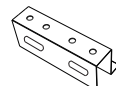

②0 2pcs

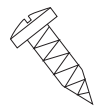

①S 8pcs

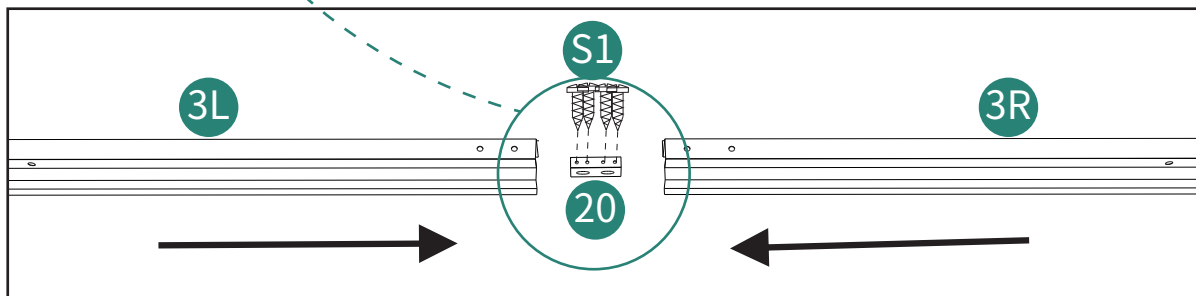
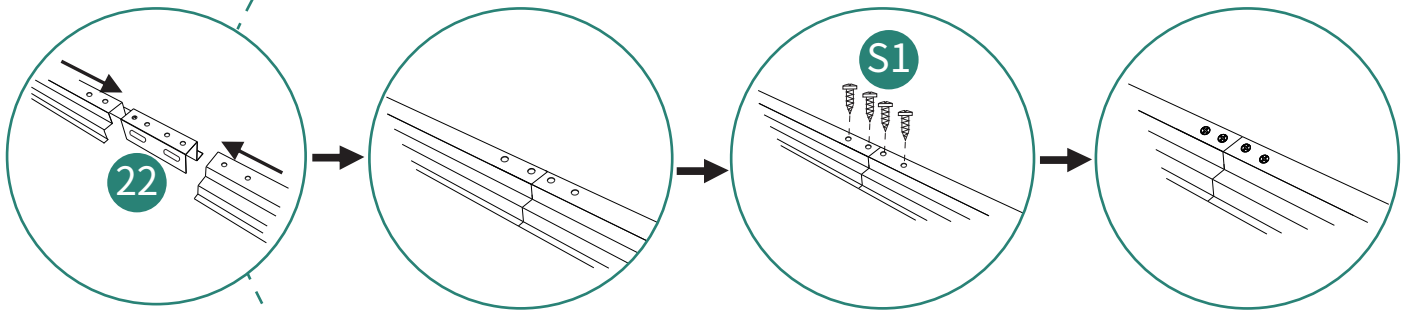
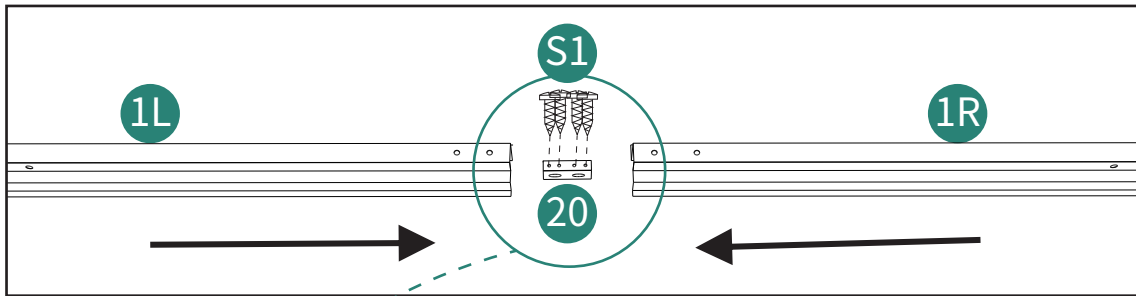

2



2 2pcs





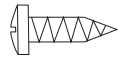

F 4pcs

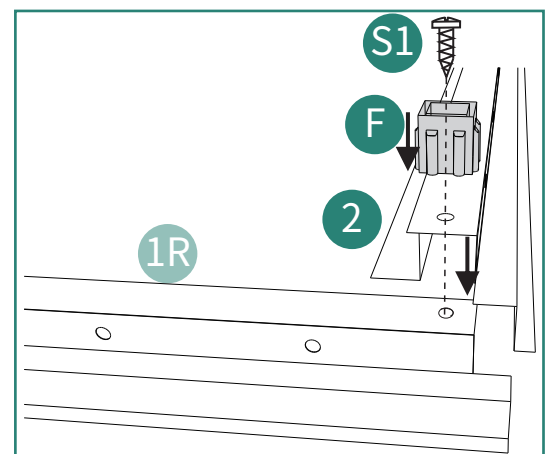
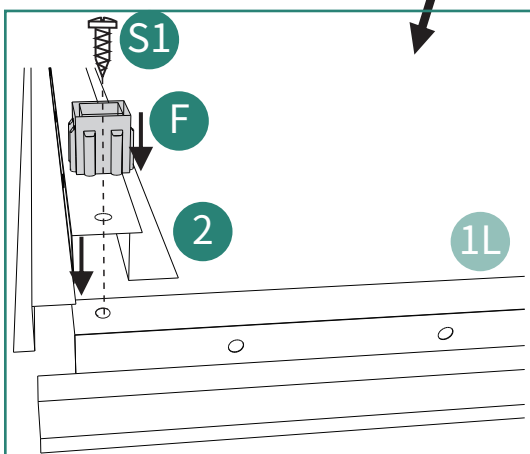
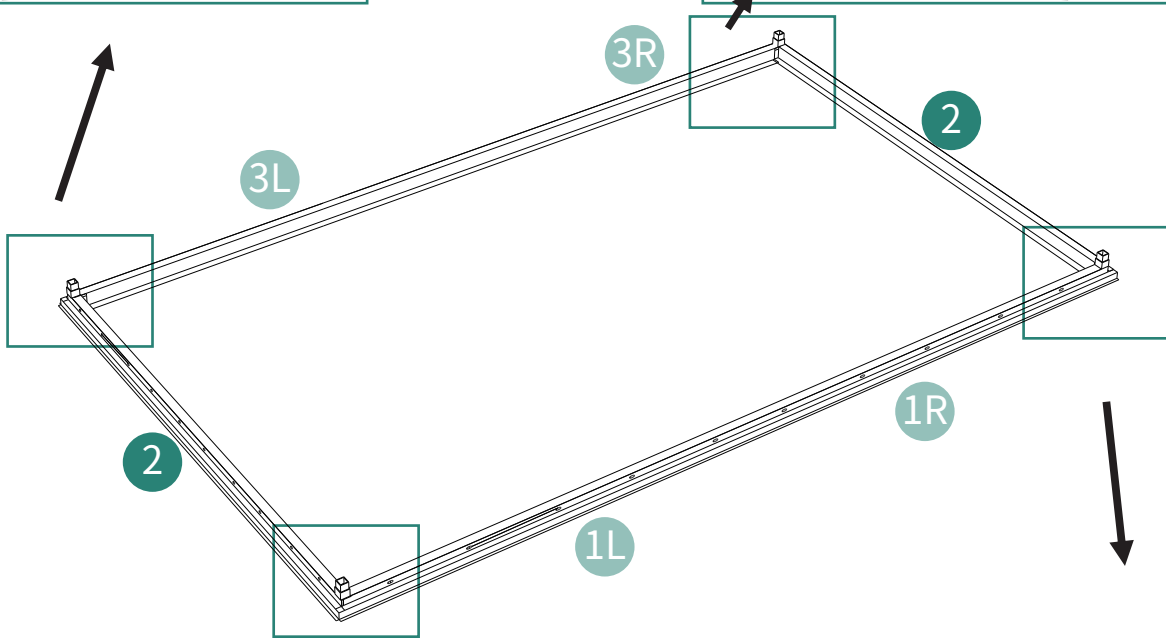
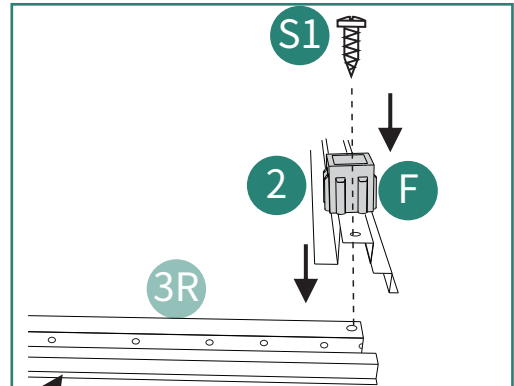
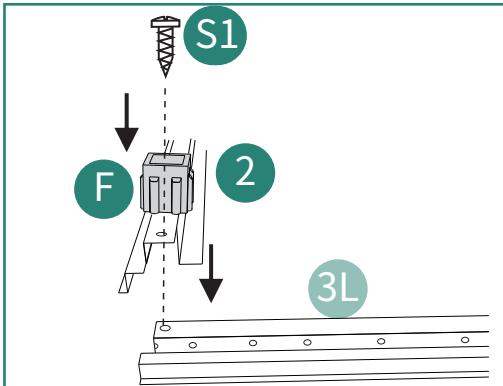

S1 4pcs

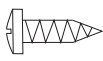

3
X2

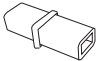
				
(33) 2pcs	(34) 2pcs	(S1) 4pcs	(F) 2pcs	(I) 2pcs

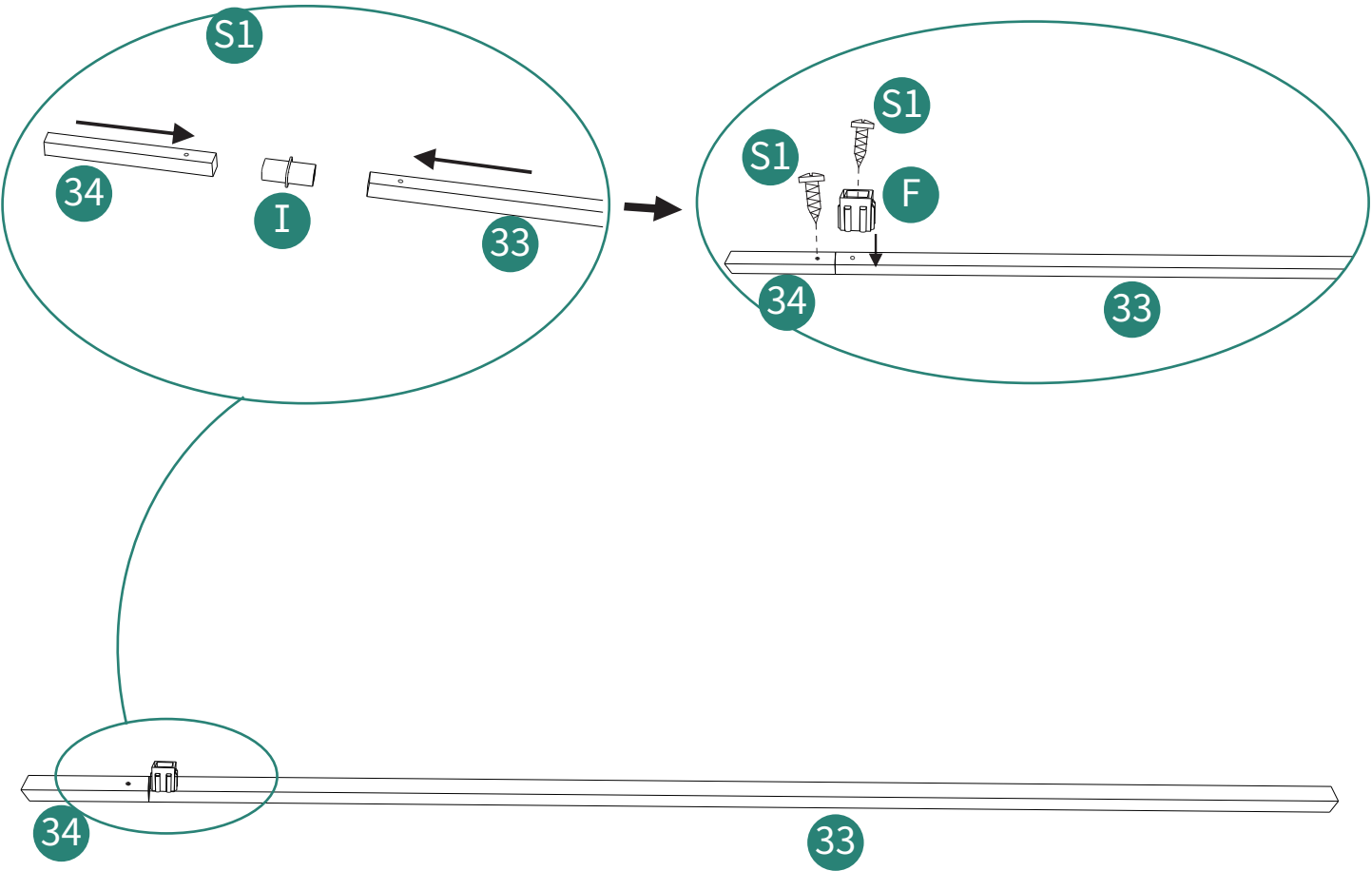

4



32 2pcs

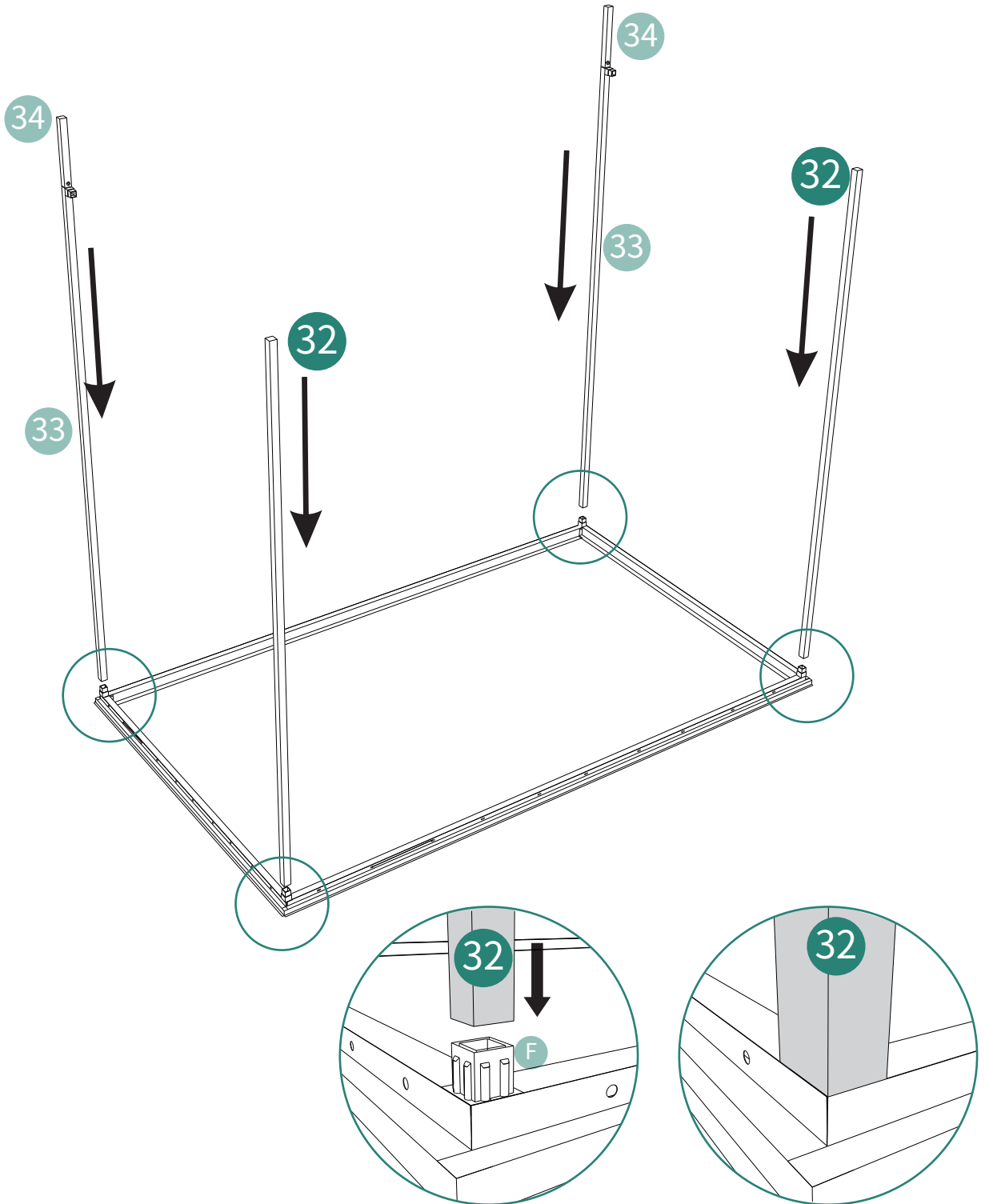

5



④L 1pc



④R 1pc



④ 1pc

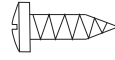

⑤S1 4pcs



⑥I 2pcs

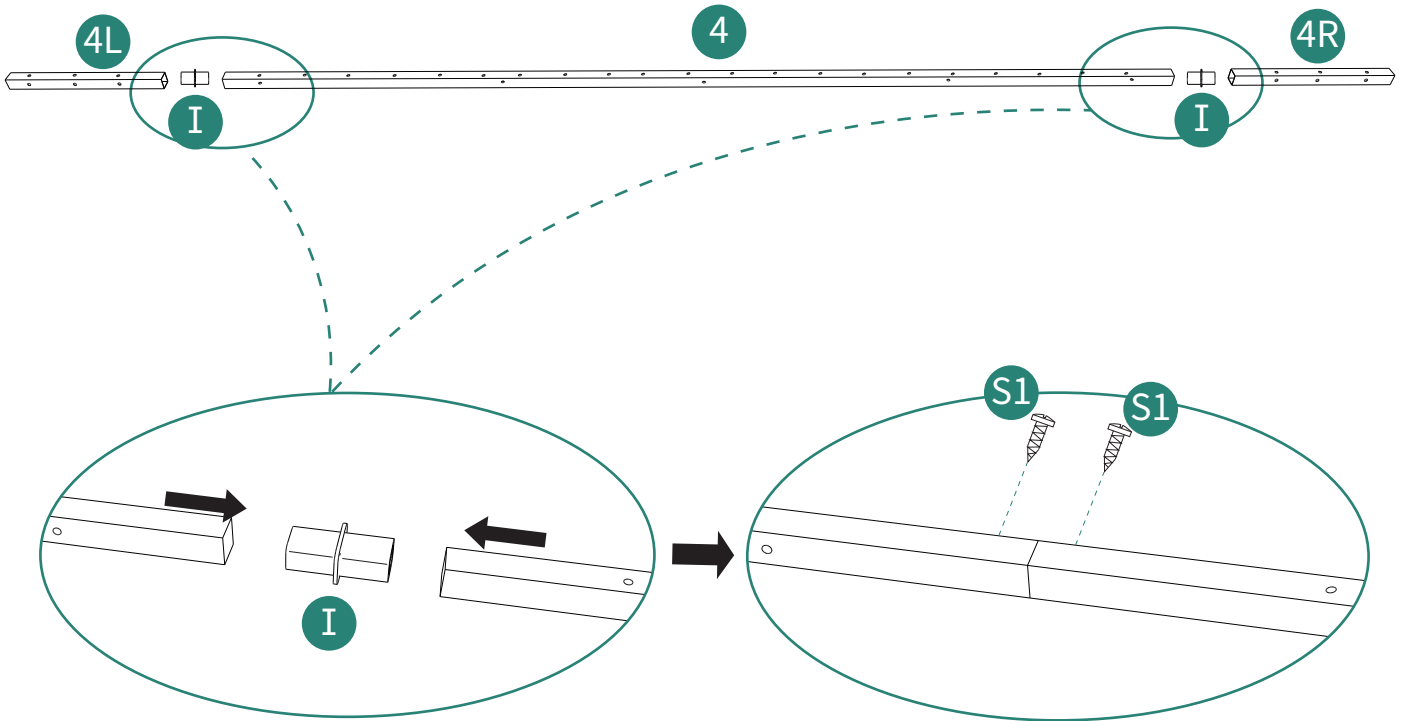

6



④ 1pc



④A 1pc

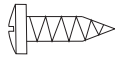

①S1 6pcs

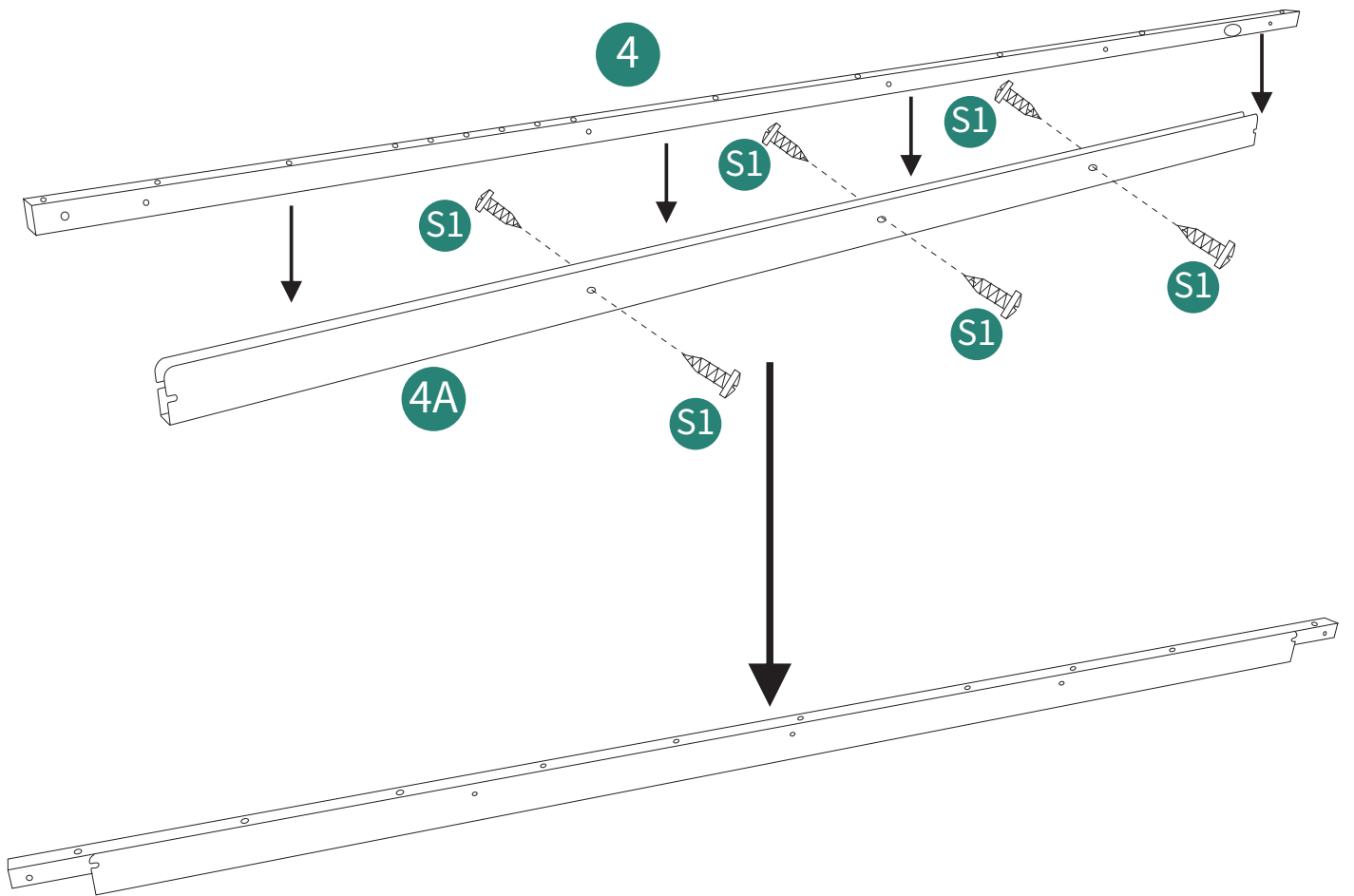

7



5B 1pc



5F 1pc

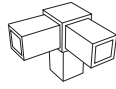

E 2pcs

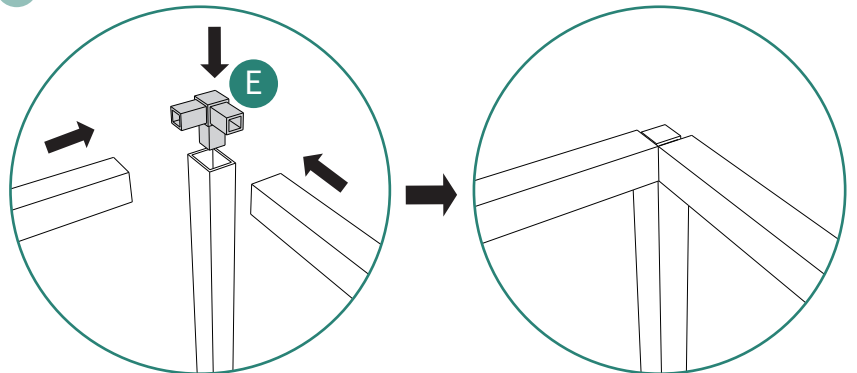
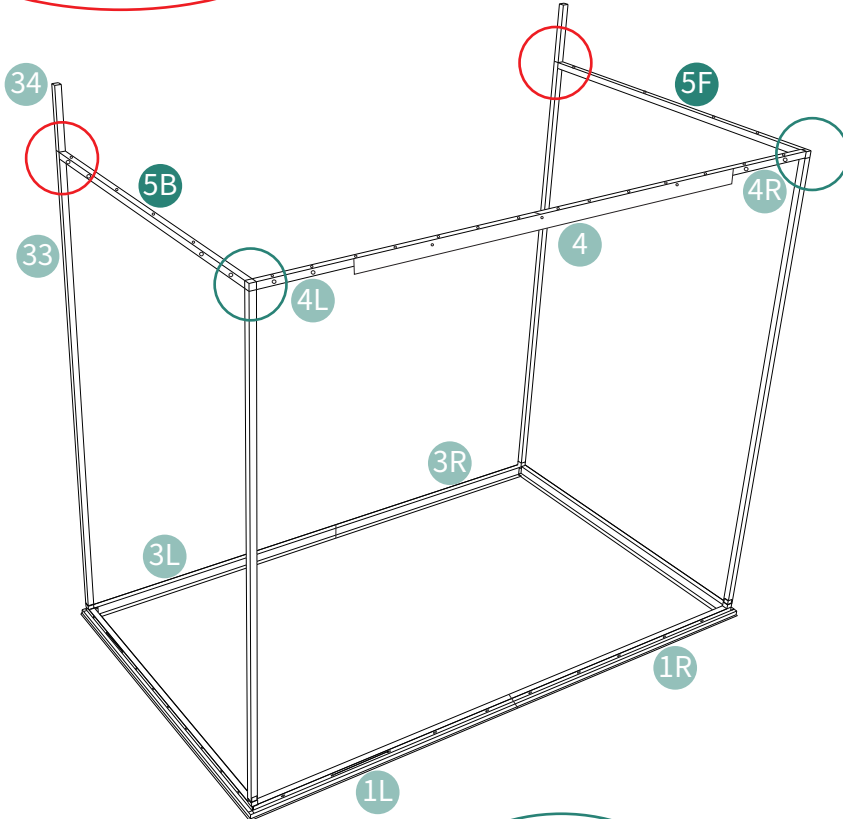
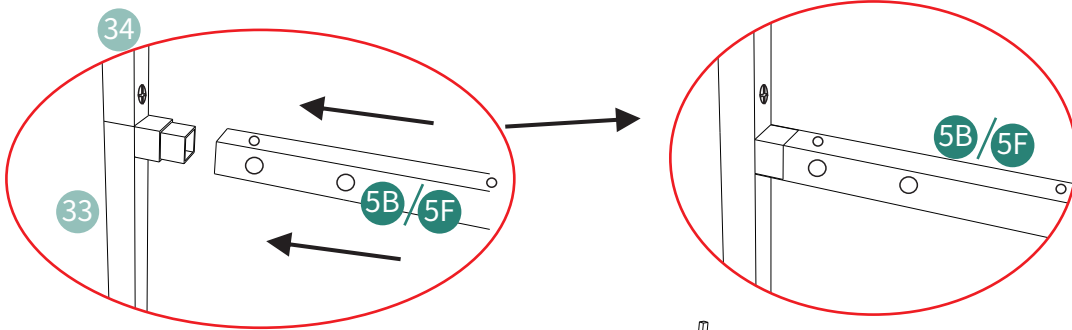

8



⑥L 1pc



⑥R 1pc

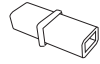

① 1pc

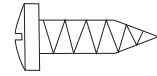

①S1 2pcs

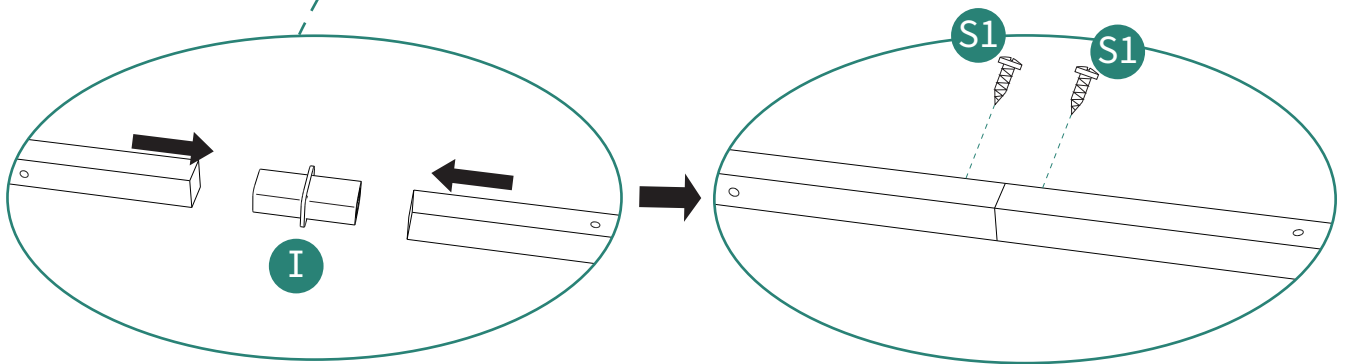
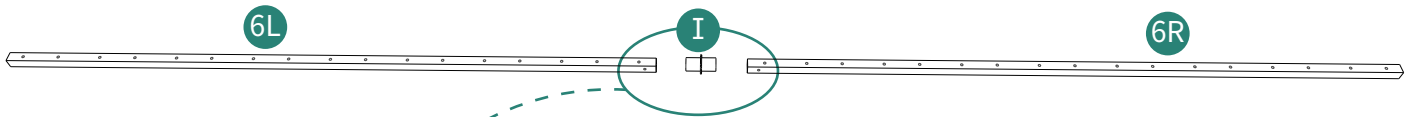

9

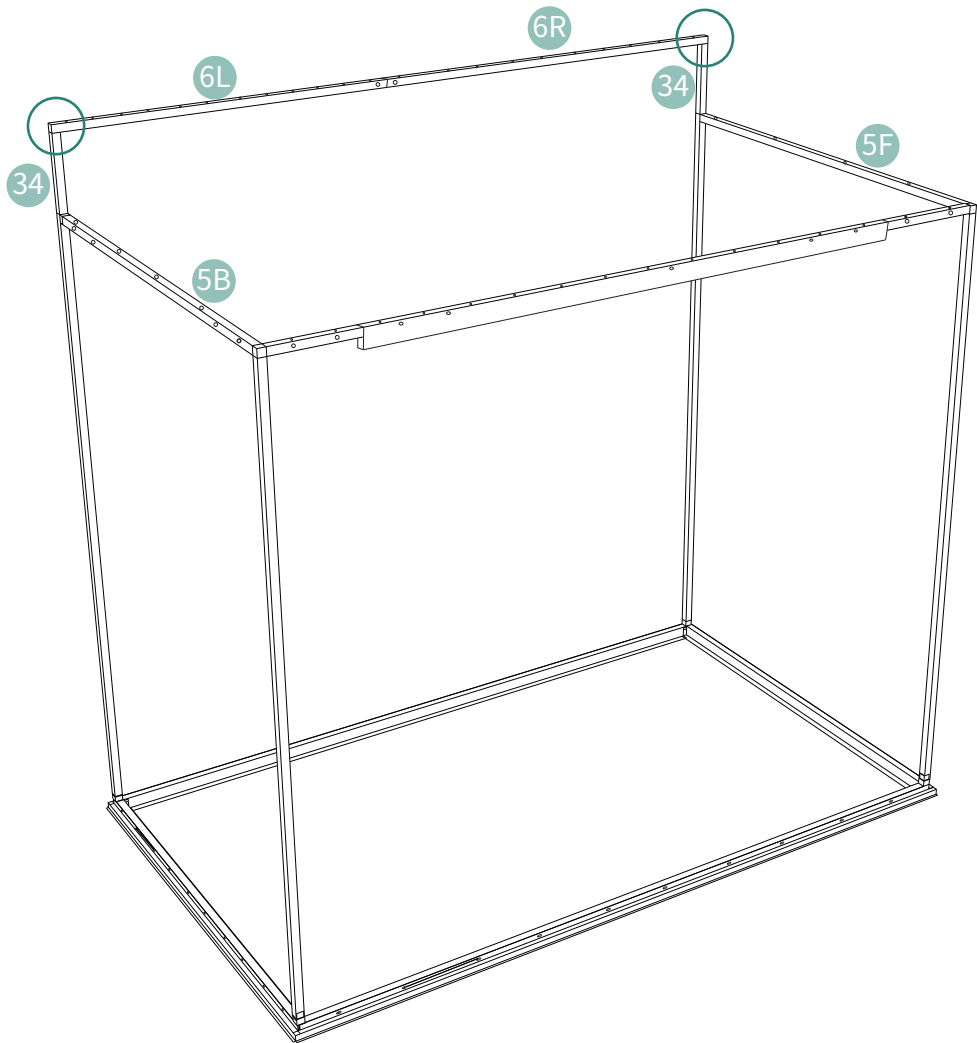
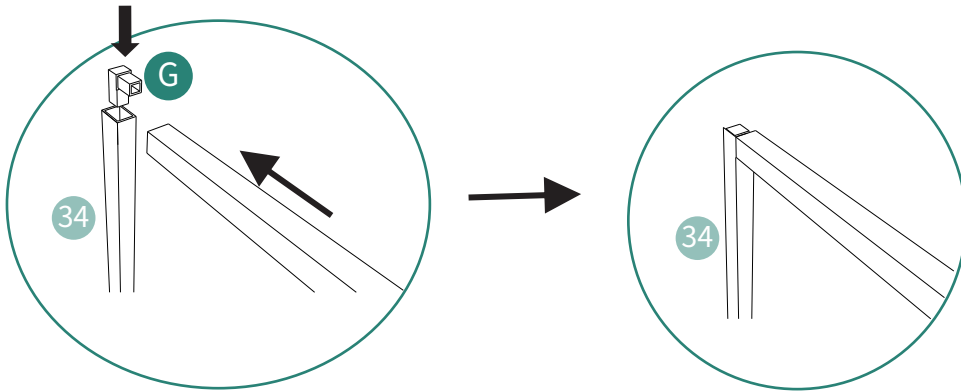
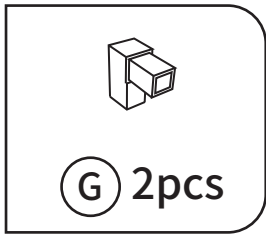

10

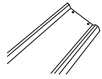

Ⓚ1 3pcs Ⓚ2 1pc Ⓚ4 1pc Ⓚ1 1pc Ⓚ2 9pcs Ⓚ3 9pcs Ⓚ4 9pcs

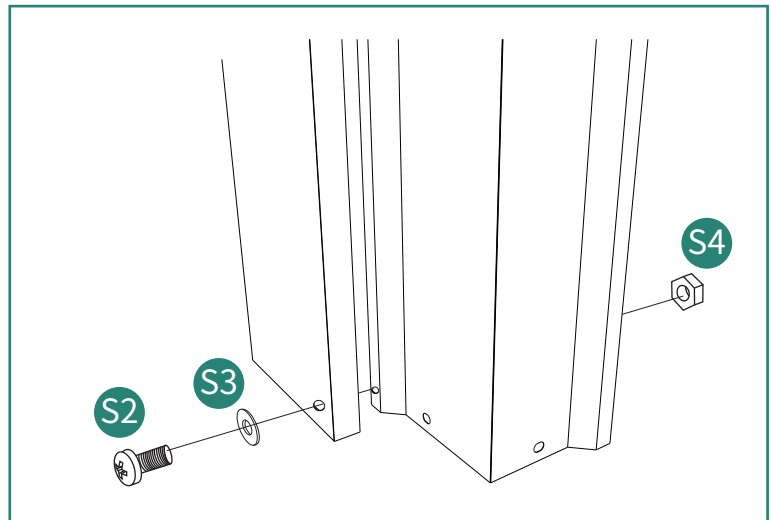
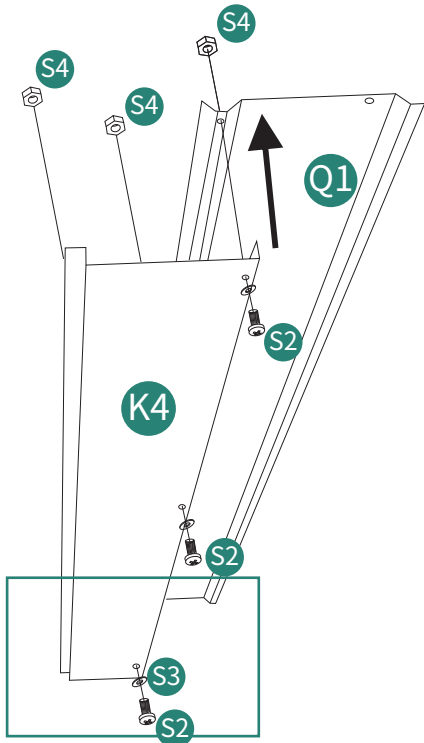
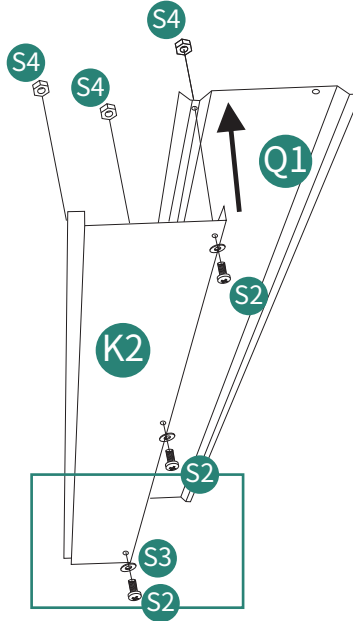
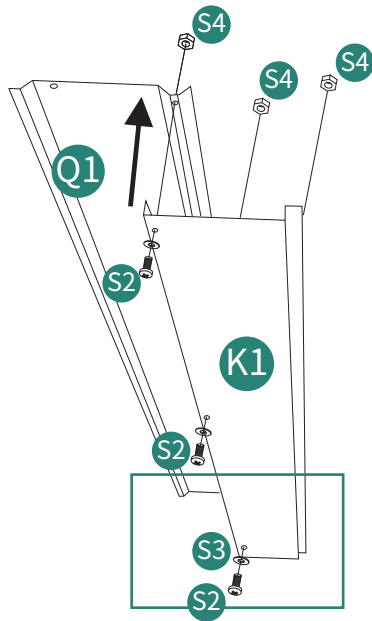

11



37 1pc



S2 6pcs



S3 6pcs



S4 6pcs

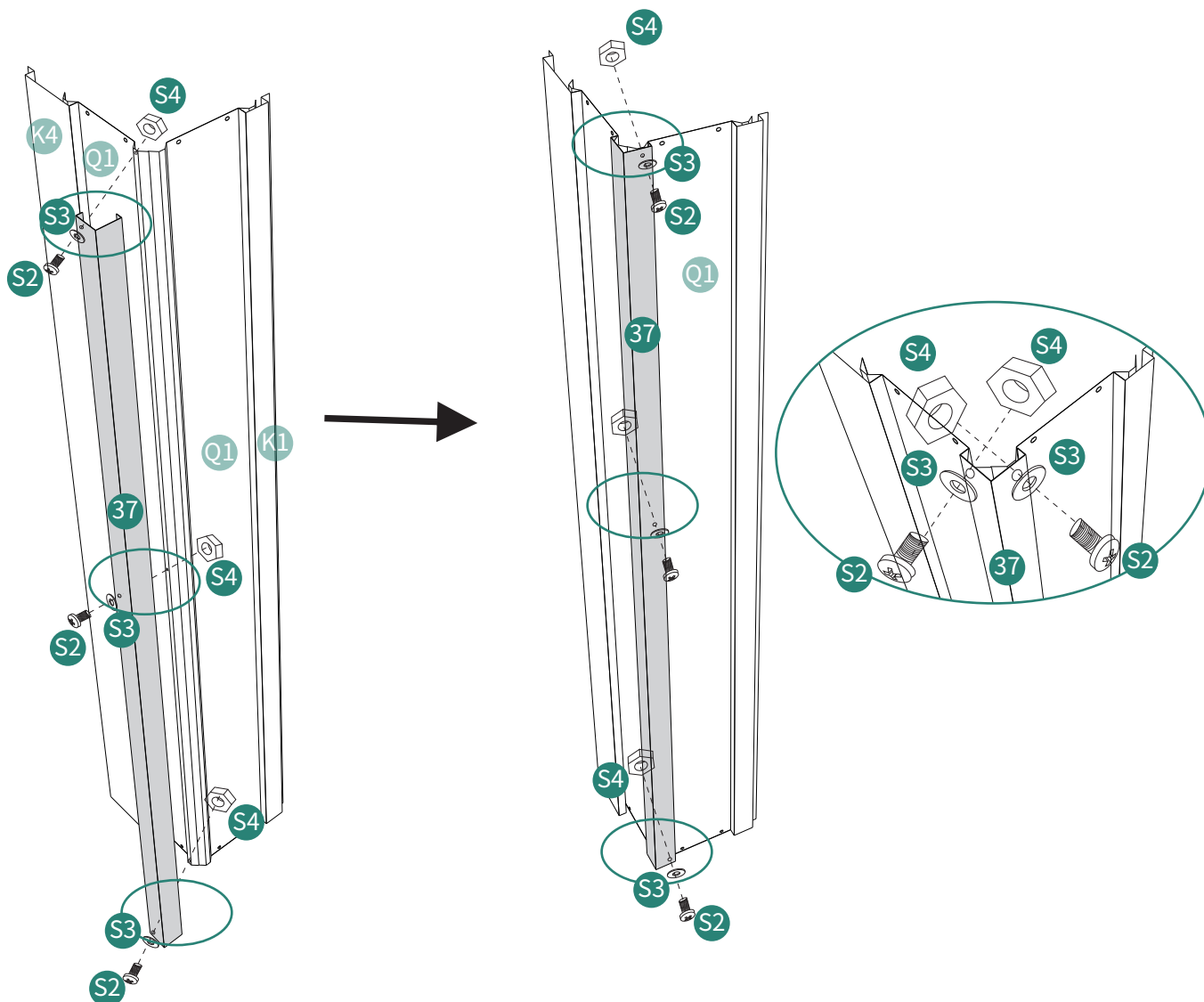

12

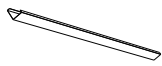

37 1pc

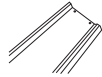

Q1 1pc



S2 6pcs



S3 6pcs



S4 6pcs

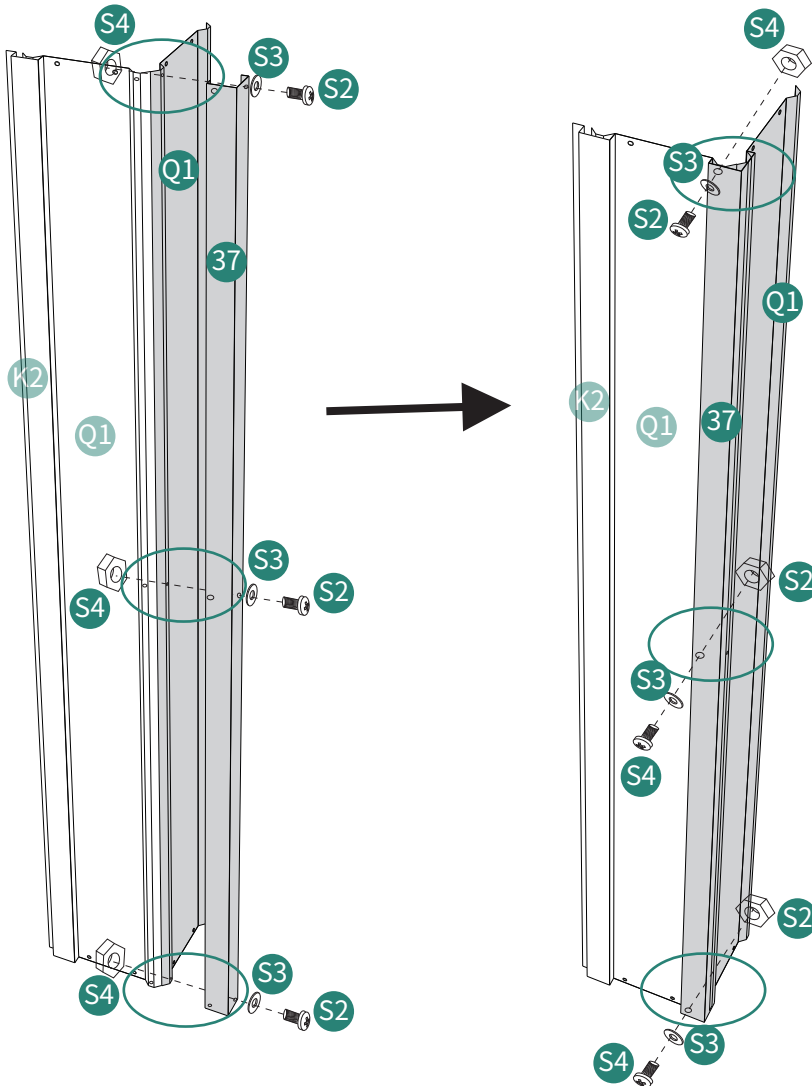
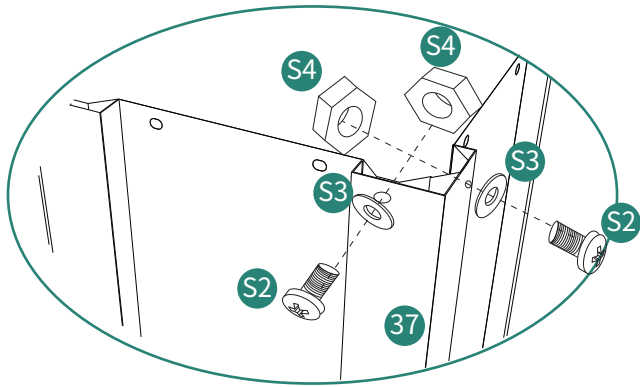

13

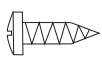

(S1) 16pcs

(S3) 16pcs

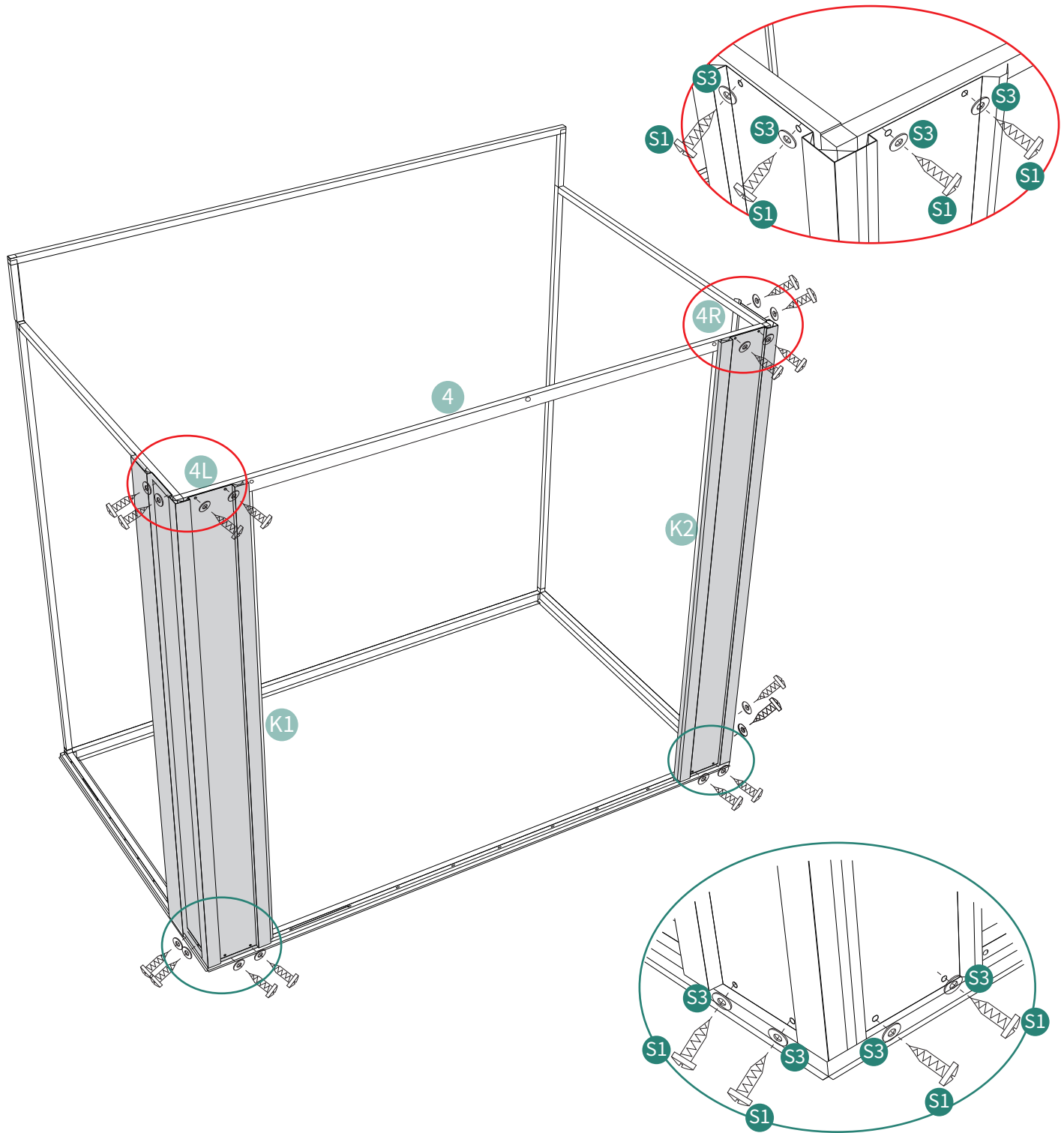

14

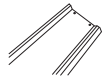

Q1 3pcs K3 1pc S2 3pcs S3 3pcs S4 3pcs

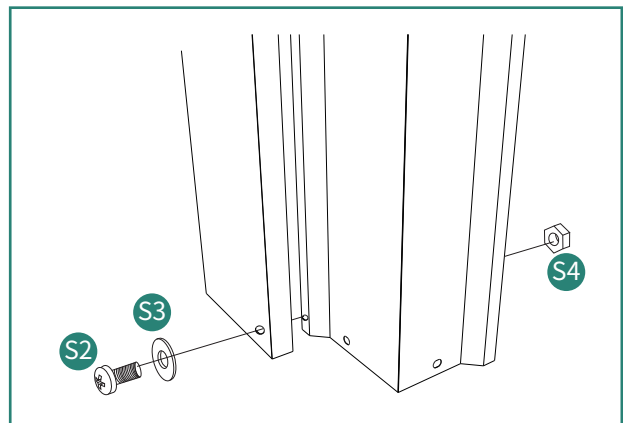
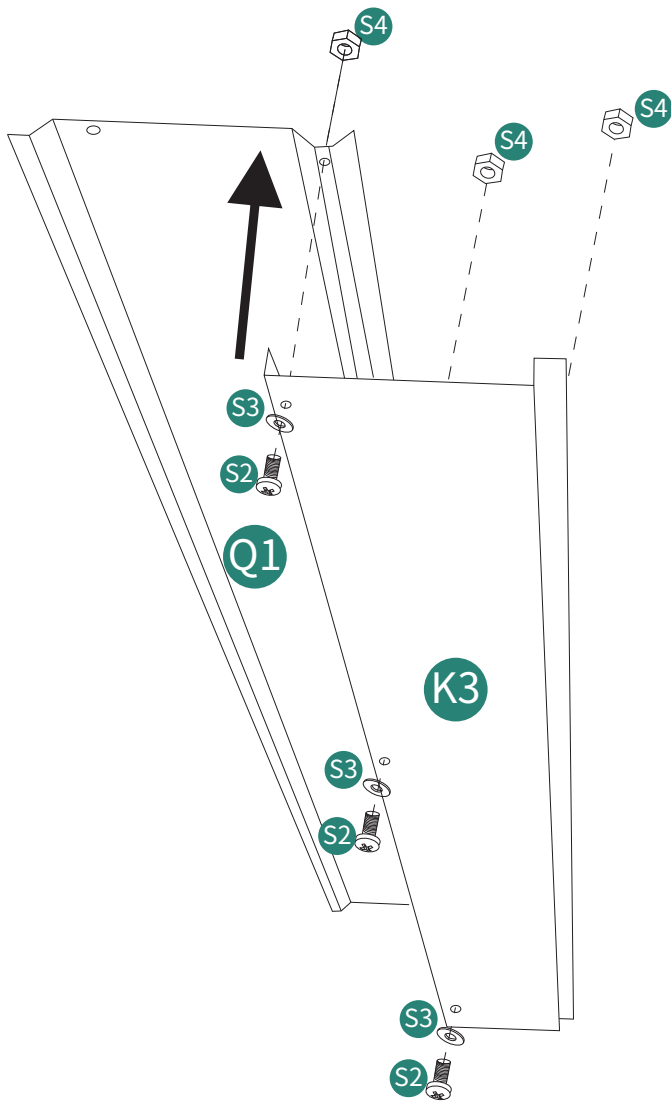

15



Q2 1pc



35 1pc



S2 6pcs



S3 6pcs



S4 6pcs

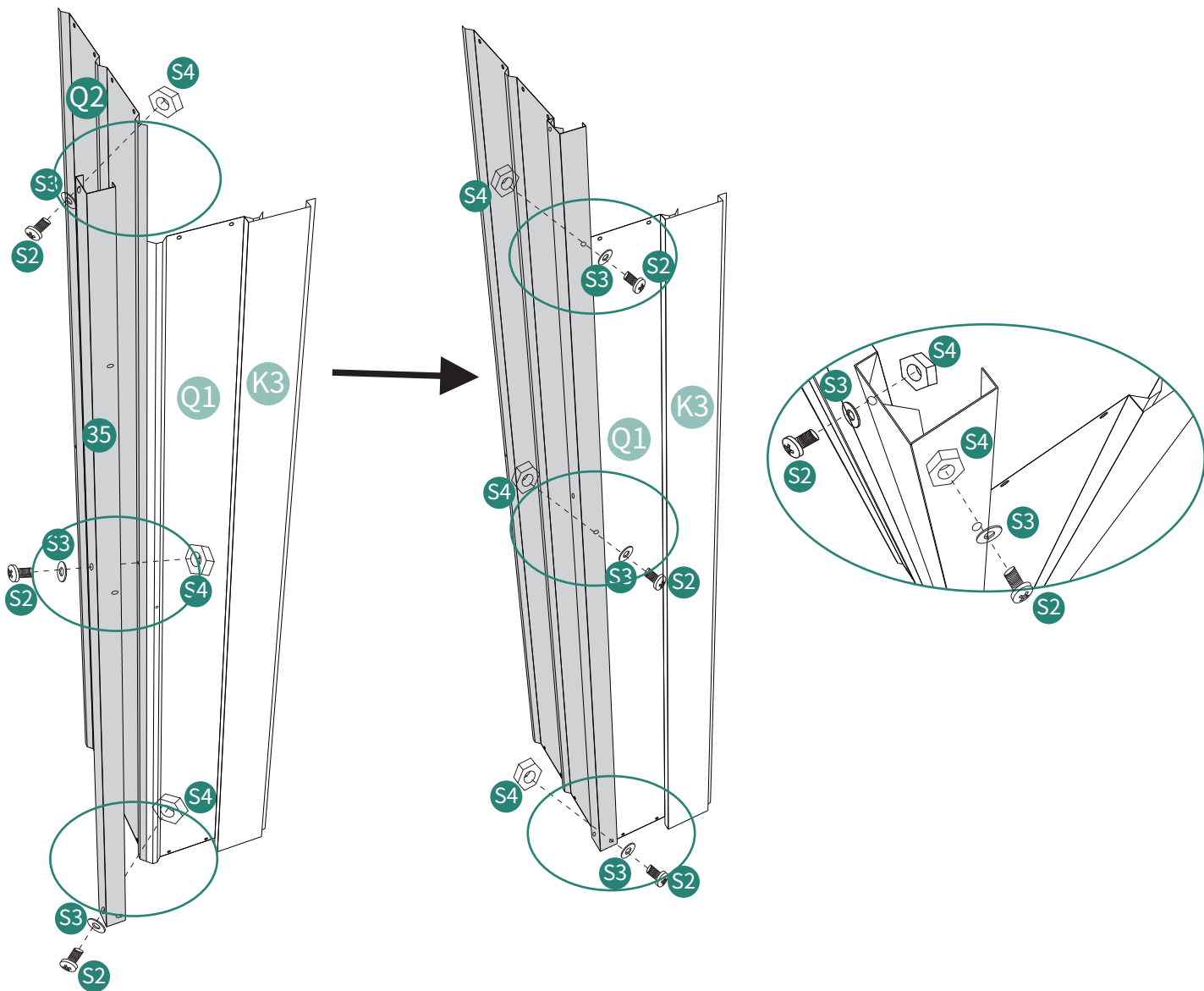

16



Q2 1pc



Q3 1pc



36 1pc



S2 6pcs



S3 6pcs



S4 6pcs

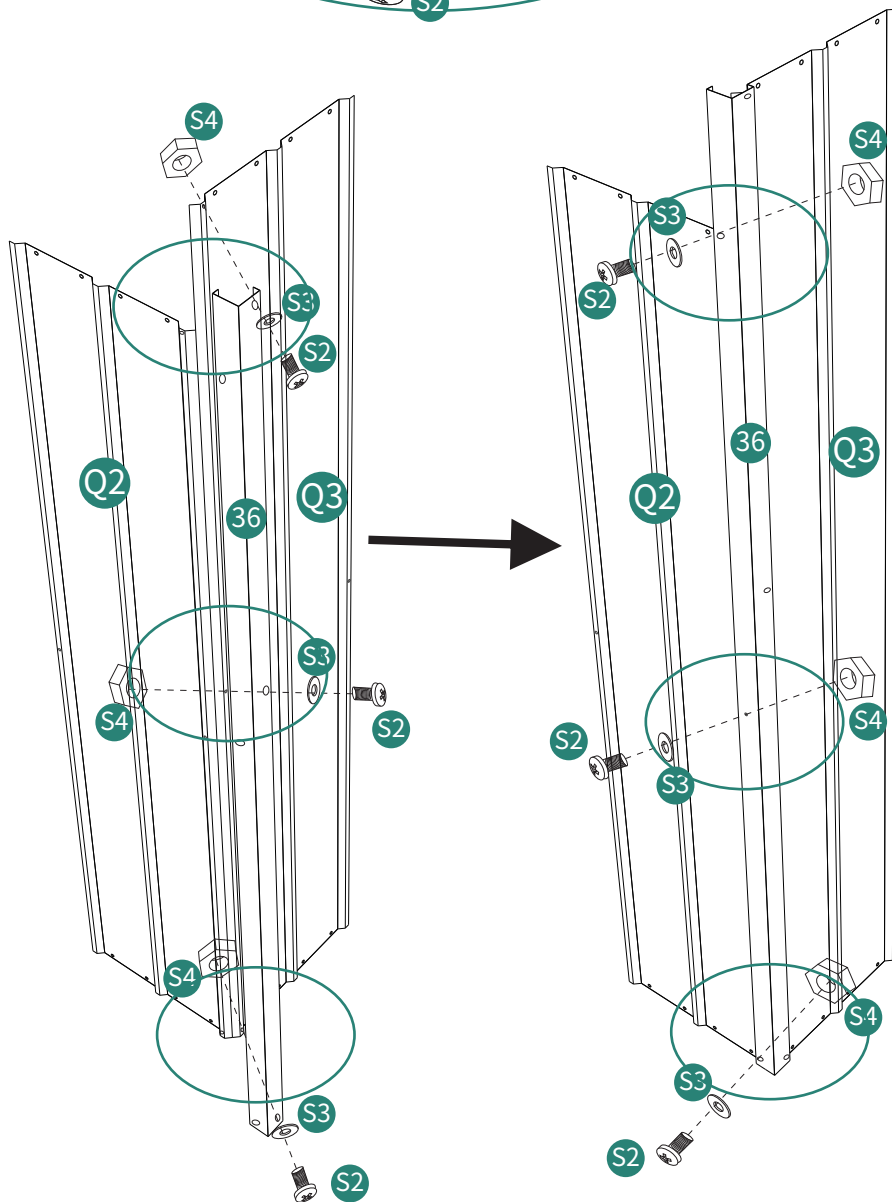
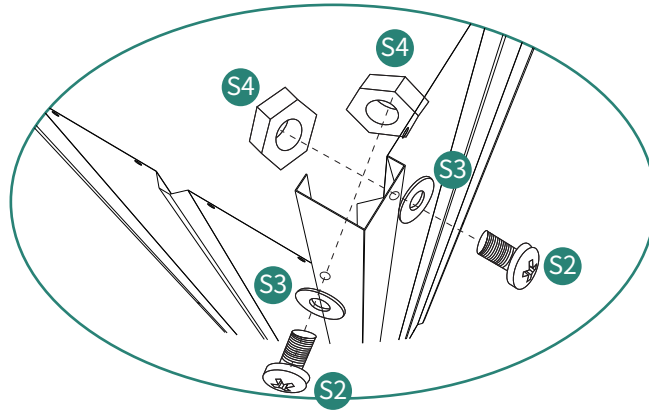

17

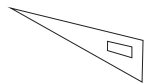

9 1pc

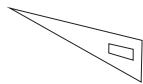

10 1pc



B 2pcs

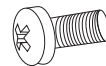

S2 4pcs



S4 4pcs

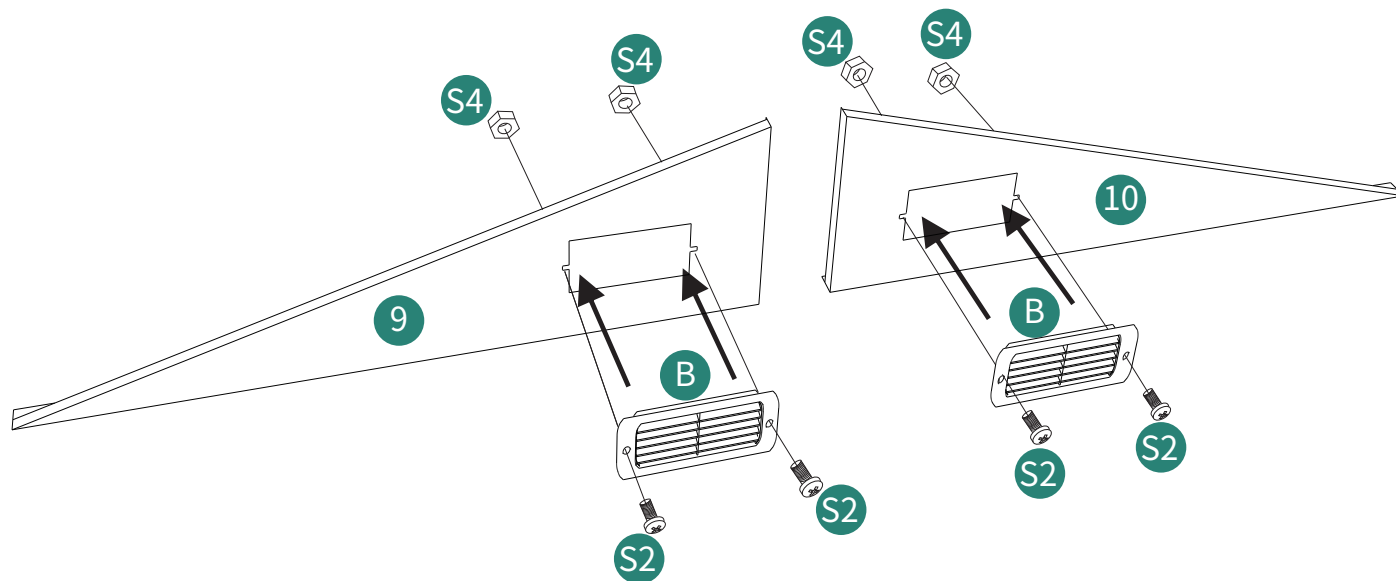

18

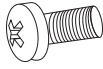

(S2) 6pcs (S4) 6pcs

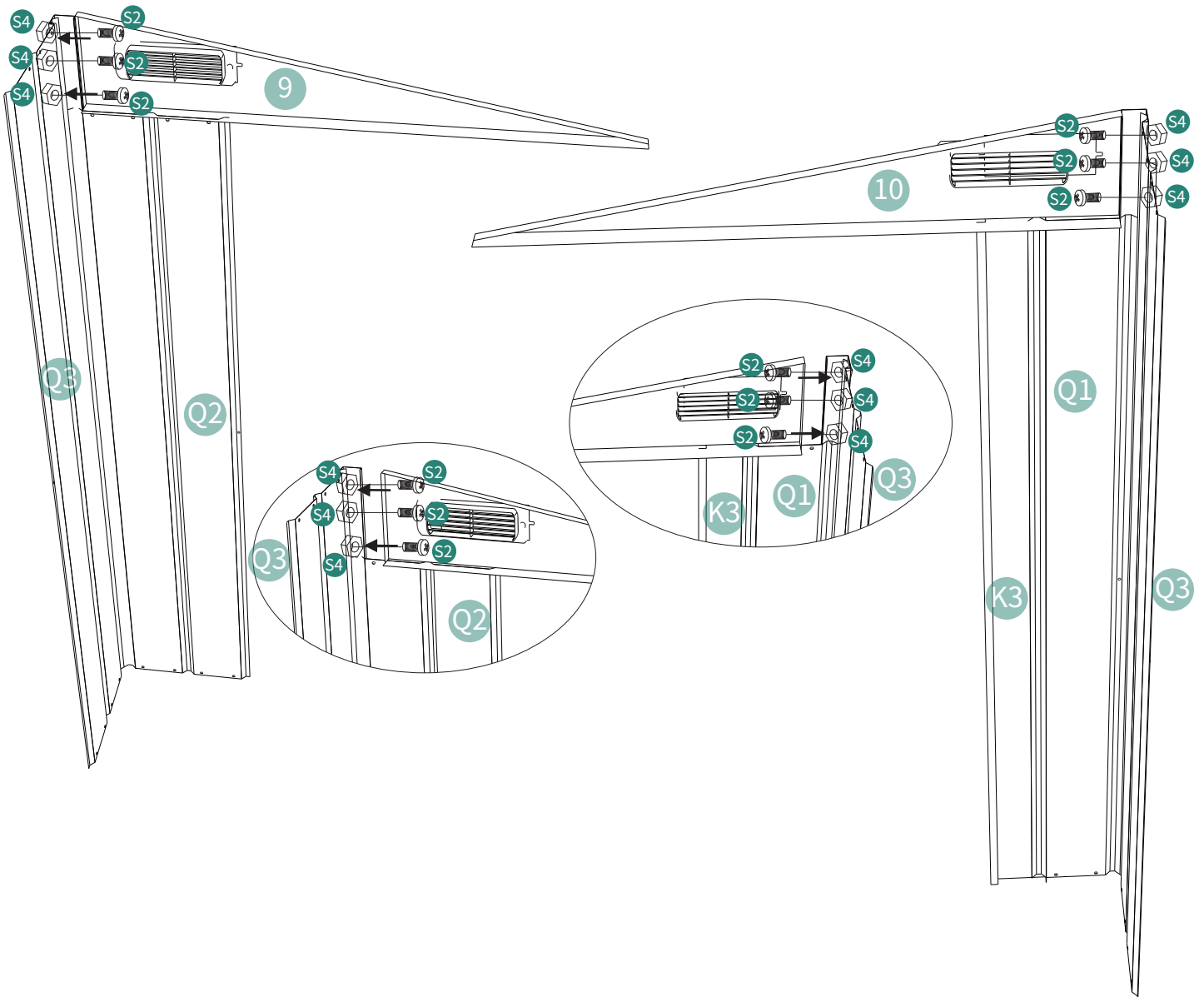

19

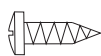

(S1) 28pcs (S3) 28pcs

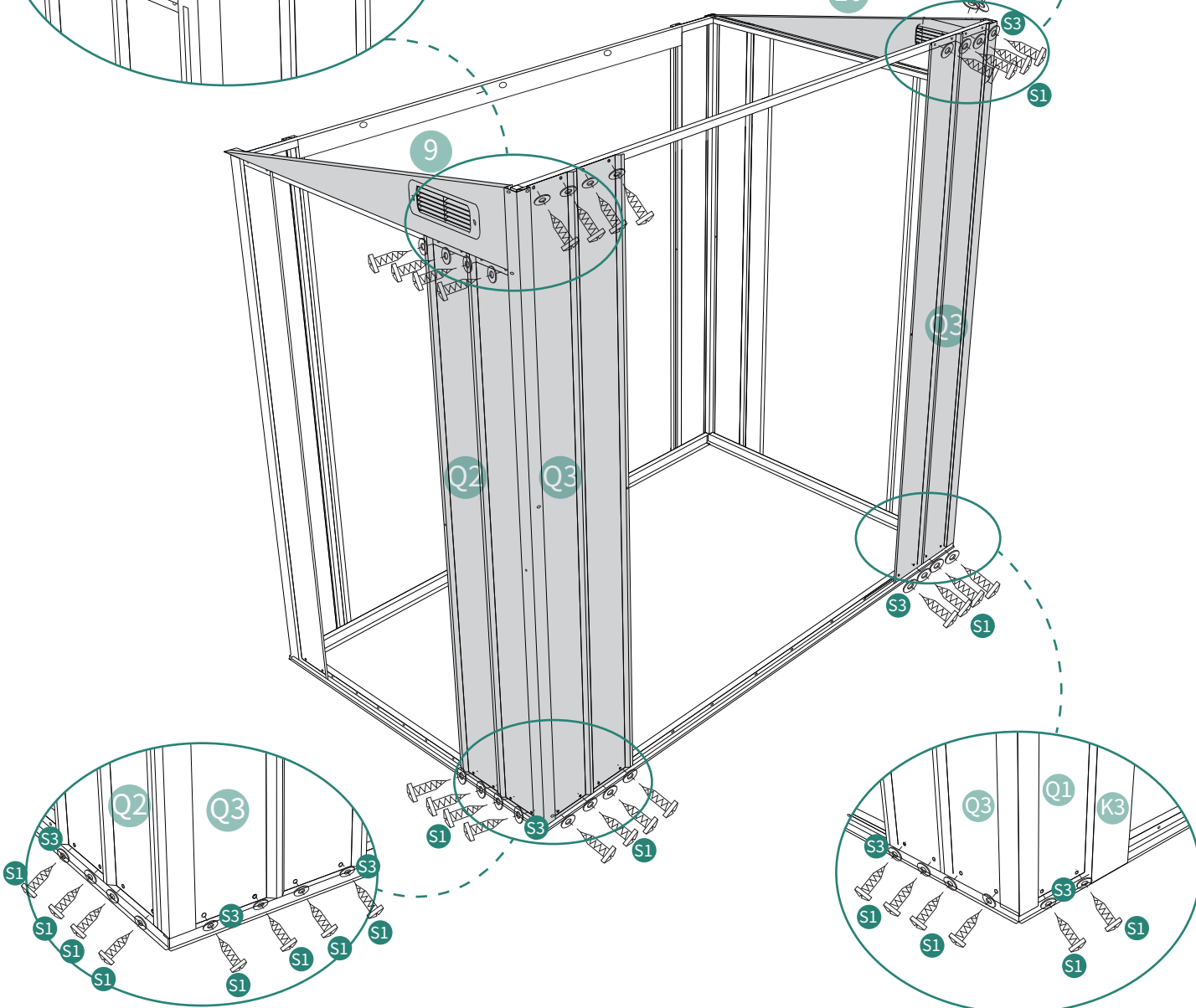
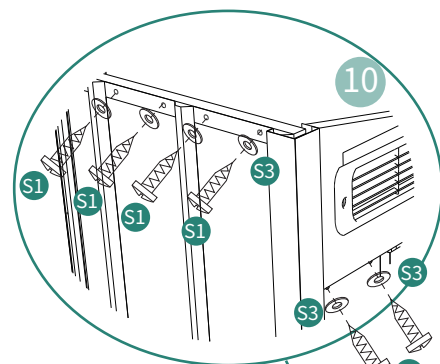
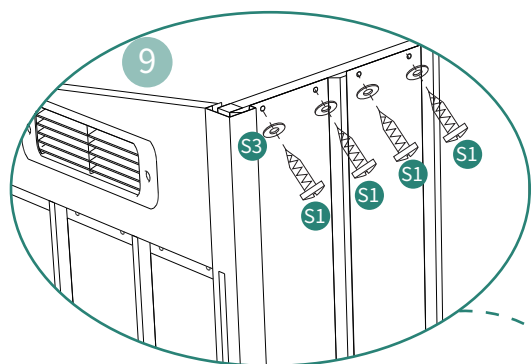

20

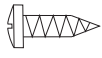

(S1) 8pcs

(S3) 8pcs

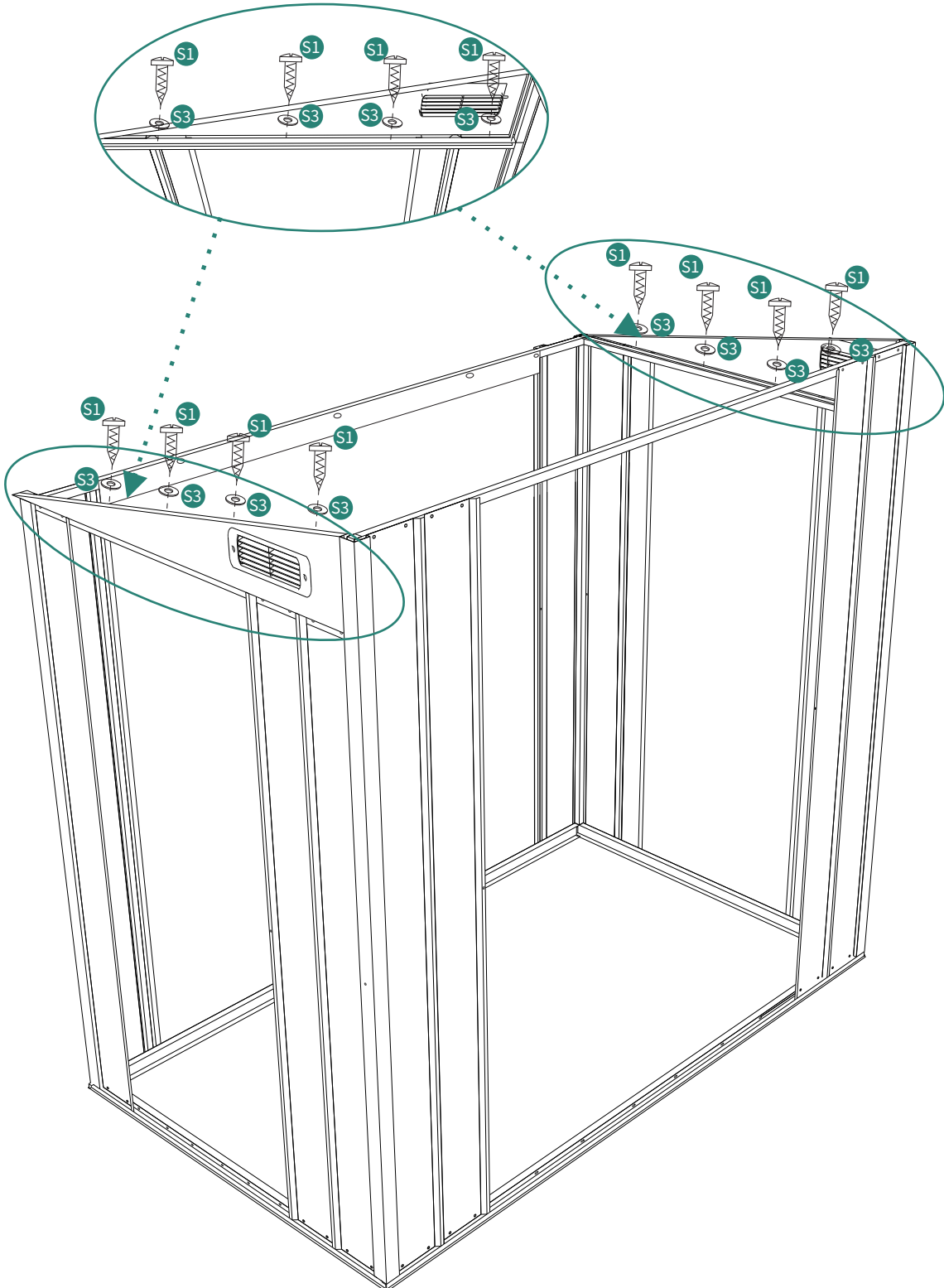

21

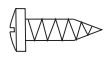

(S1) 8pcs



(S3) 8pcs

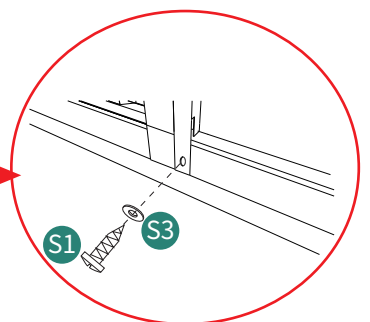
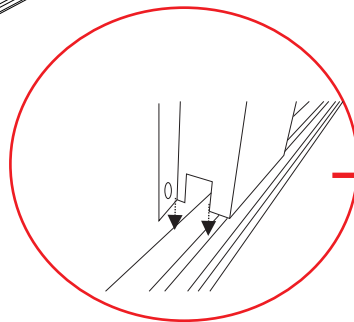
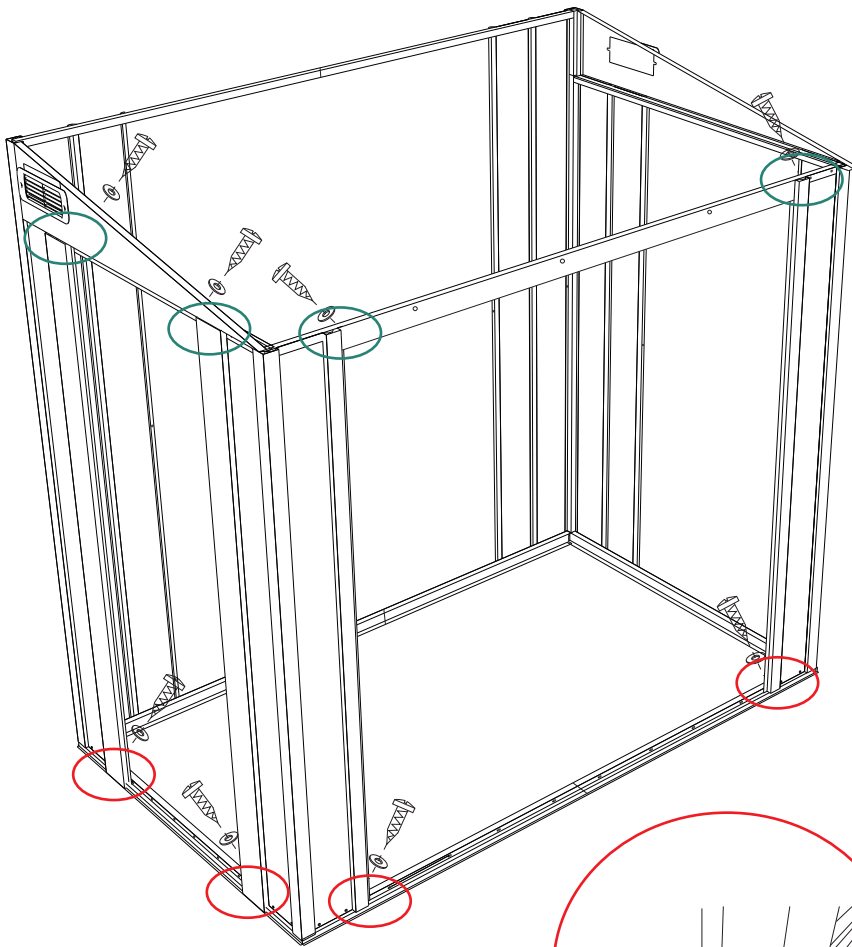
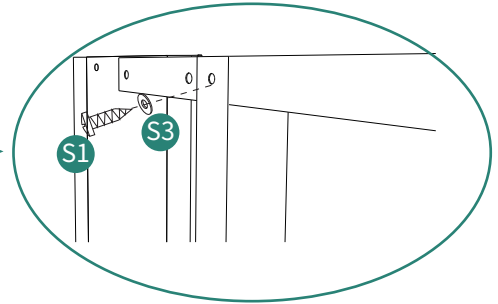
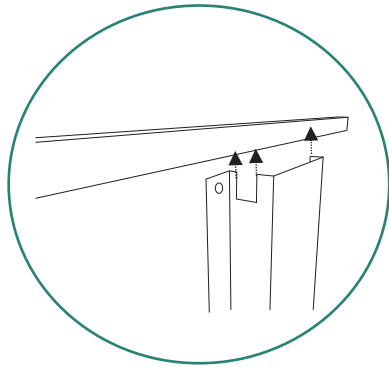

22



Q2 2pcs



Q3 4pcs

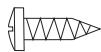

S1 48pcs

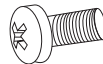

S2 8pcs







S3 56pcs

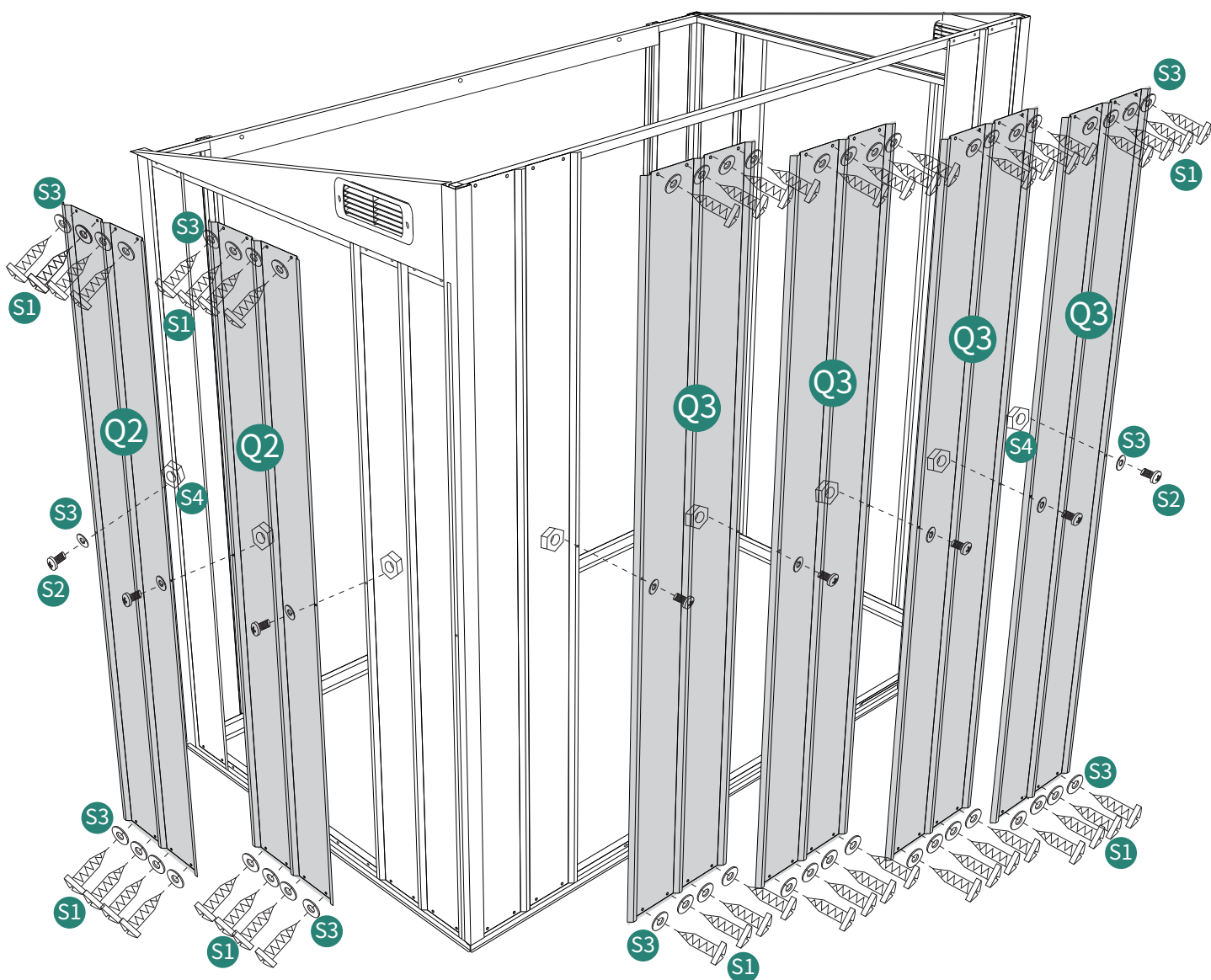

S4 8pcs

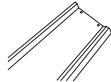

23

-  D1 2pcs
-  D2 4pcs
-  D3 1pc
-  S1 44pcs
-  S3 44pcs

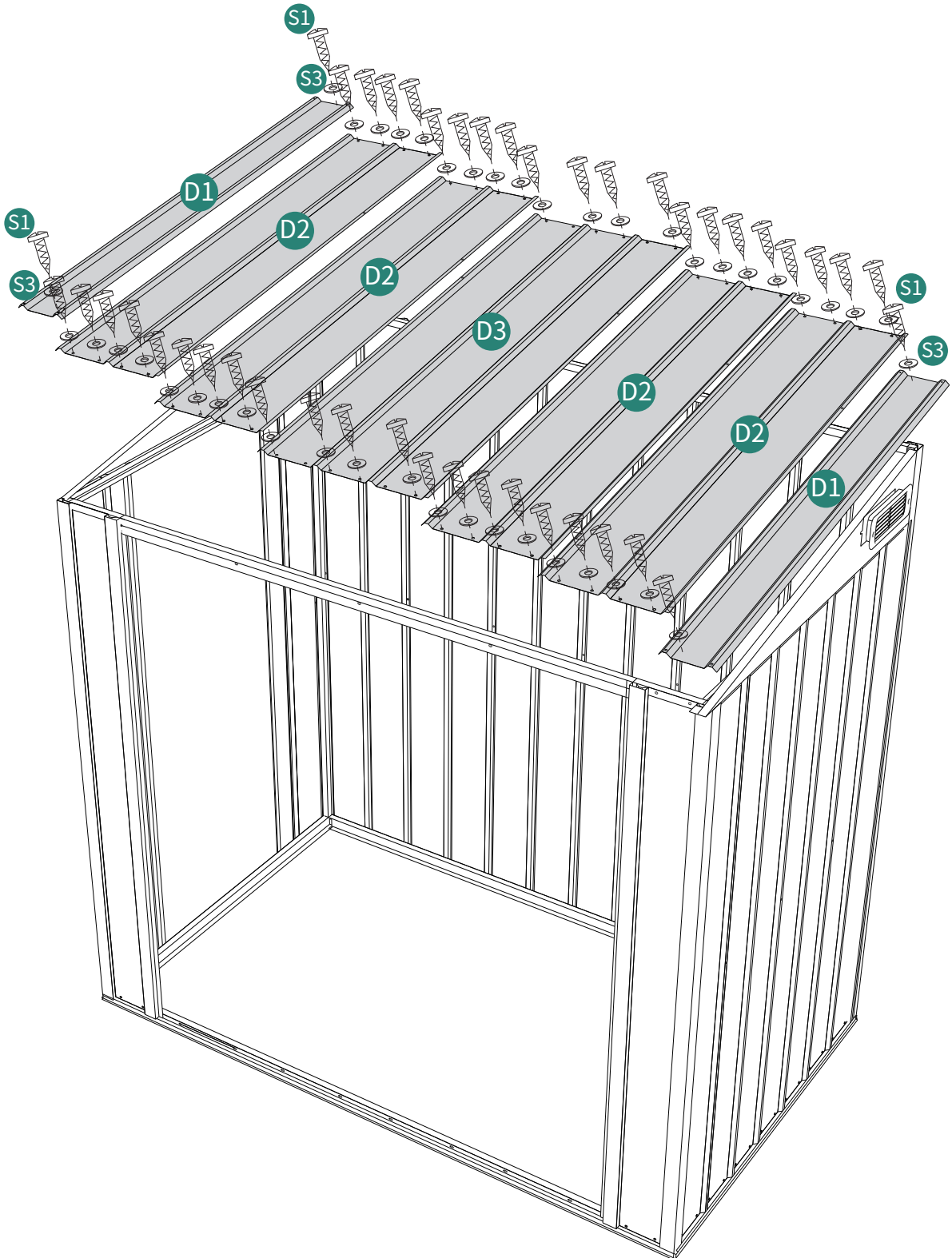

24

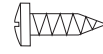

(7F) 2pcs (7B) 2pcs (8) 2pcs (C) 4pcs (J) 2pcs (S1) 6pcs (S3) 6pcs

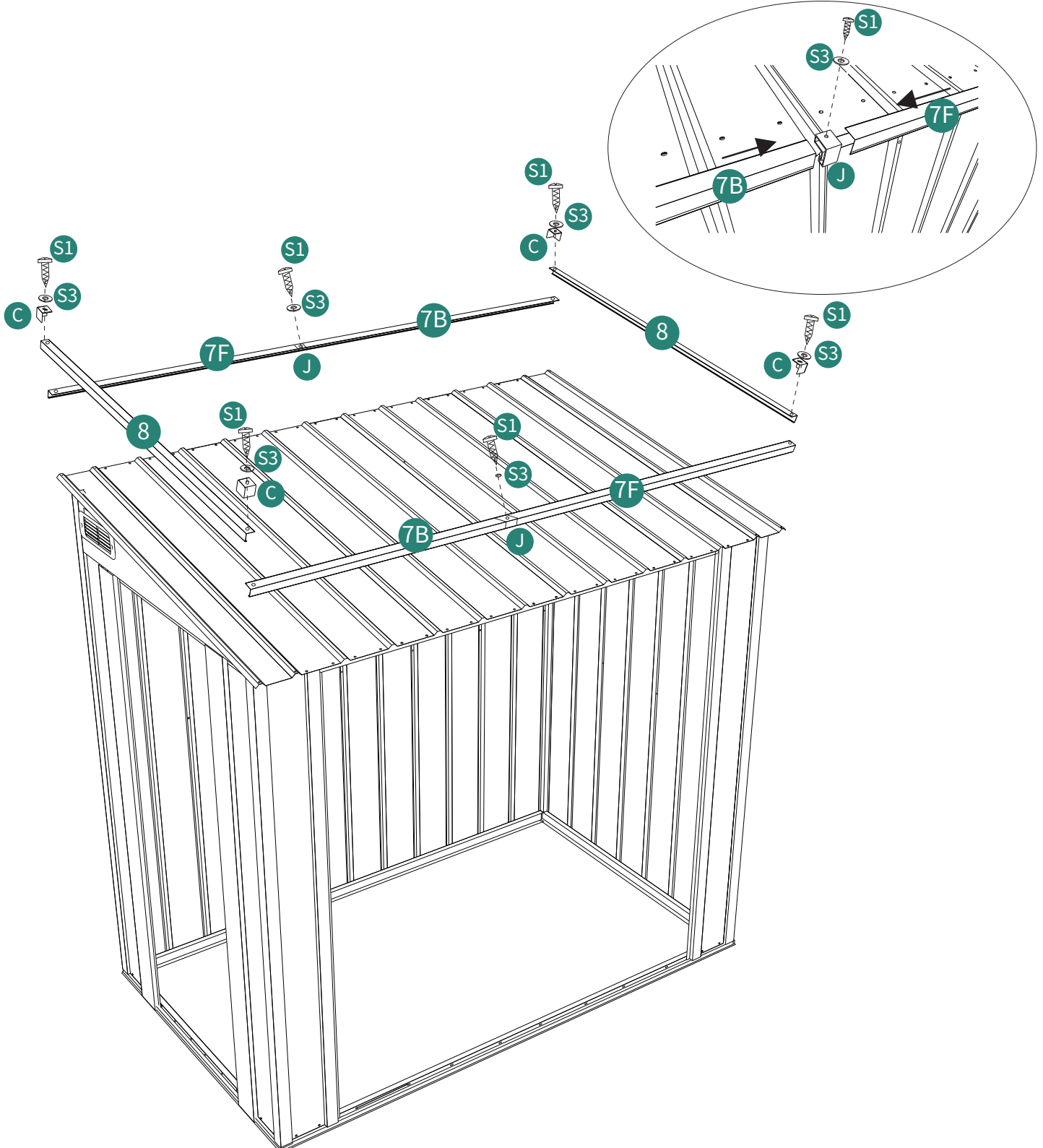

25



(M1) 4pcs

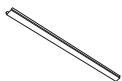

(25) 2pcs



(26) 1pc



(27) 1pc



(S2) 6pcs



(S4) 6pcs

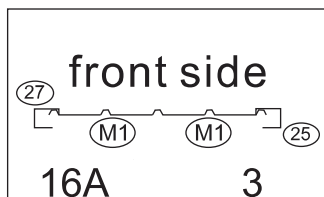
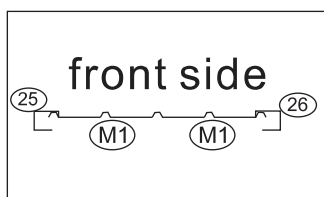
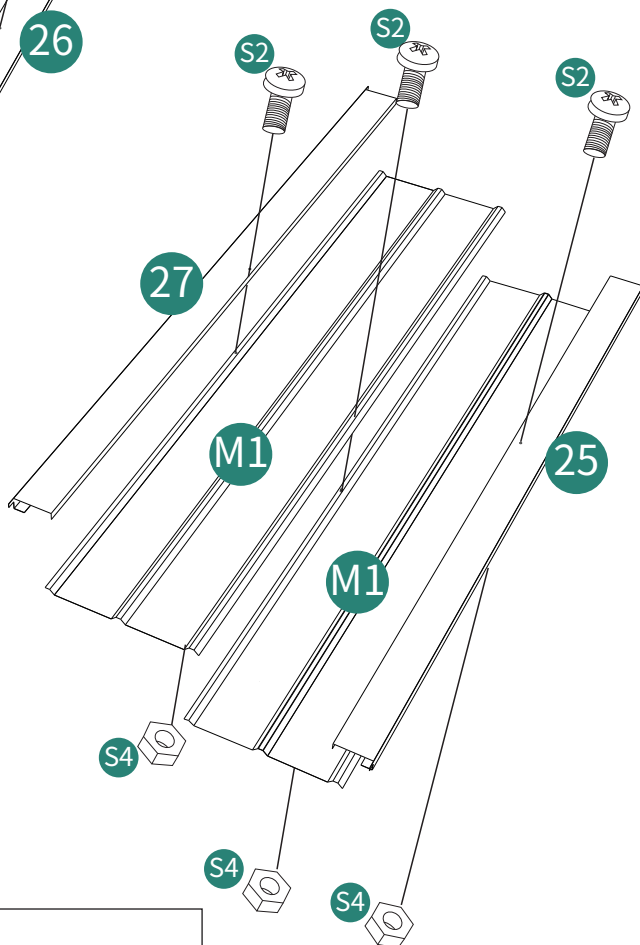
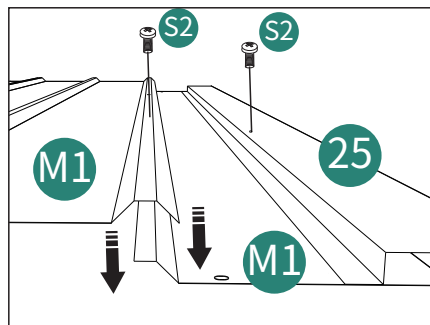
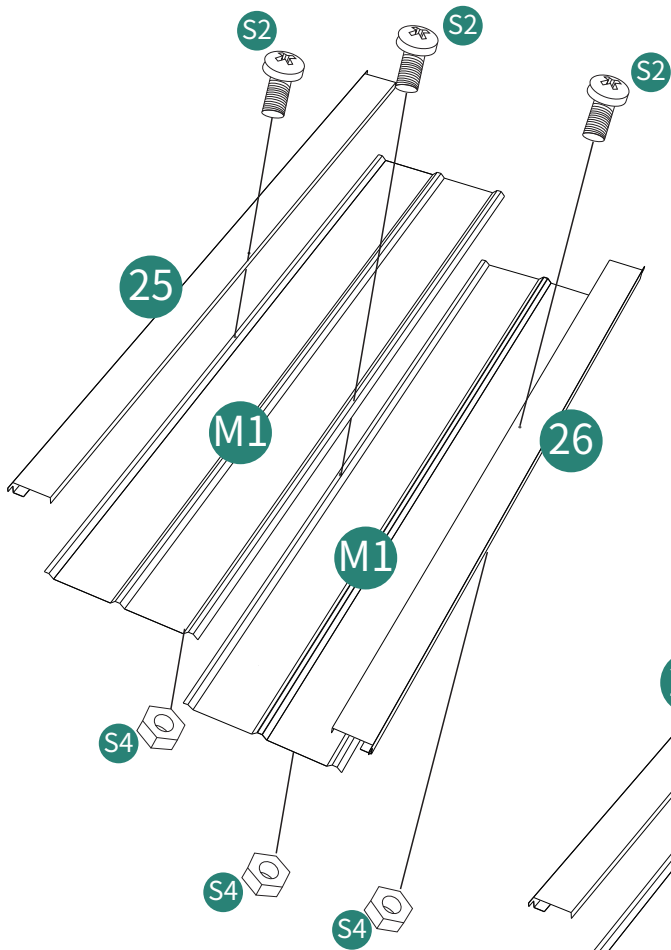

26



②4 4pcs ①S1 16pcs ③S3 16pcs

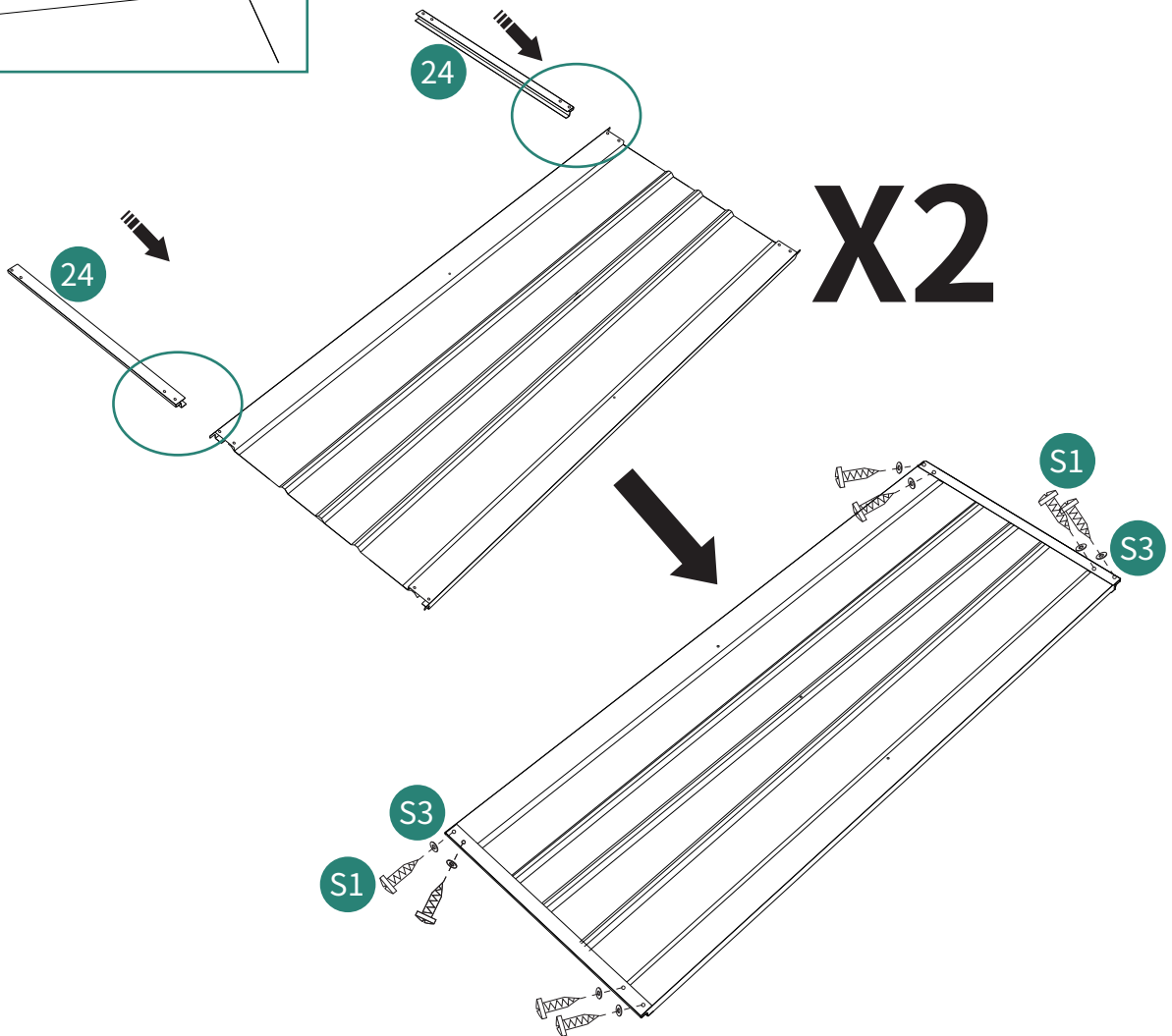
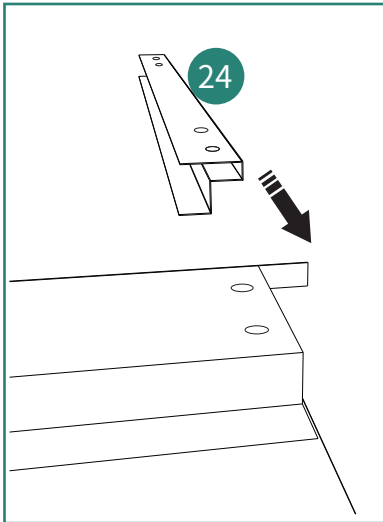

27



②8 4pcs



④4 4pcs



①8 8pcs

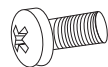

②12 12pcs



④12 12pcs

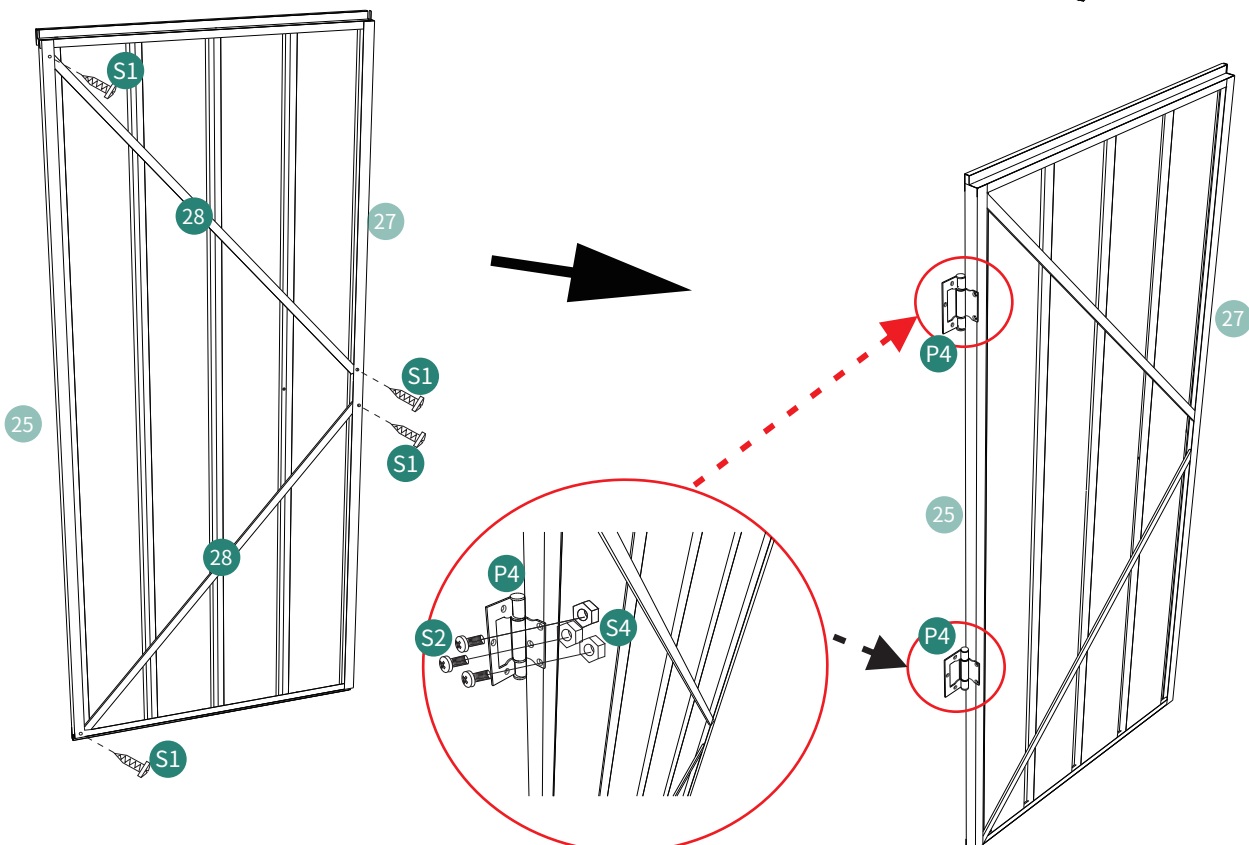
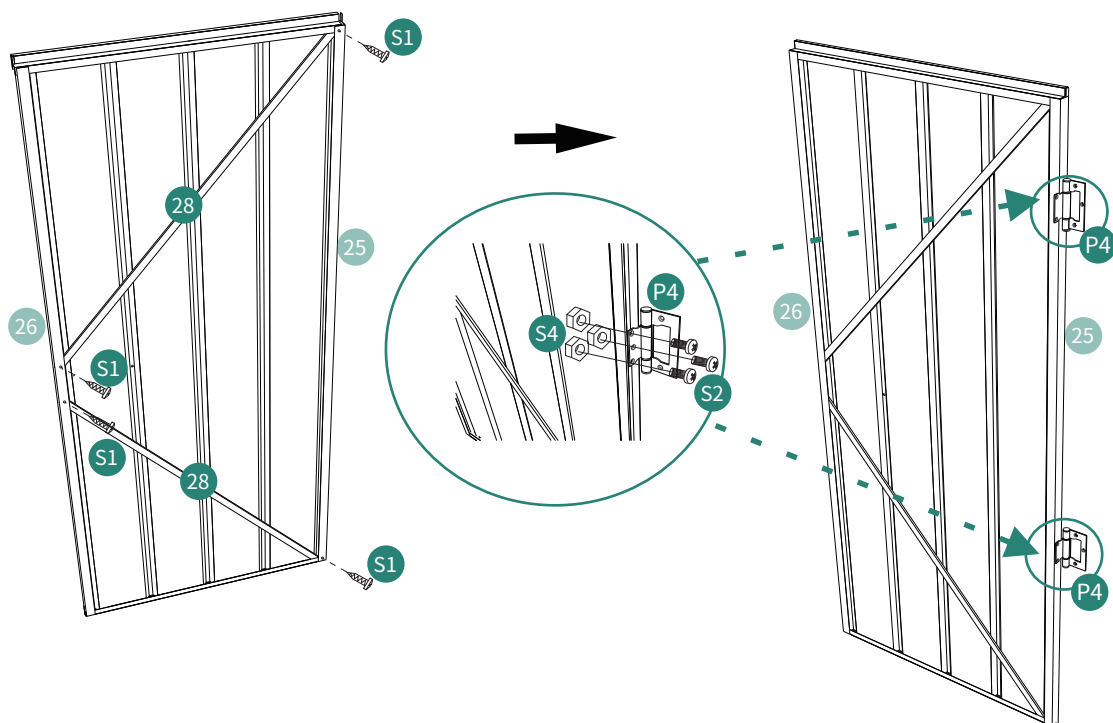

28



P4 2pcs



S1 2pcs

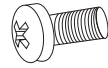

S2 4pcs



S4 4pcs

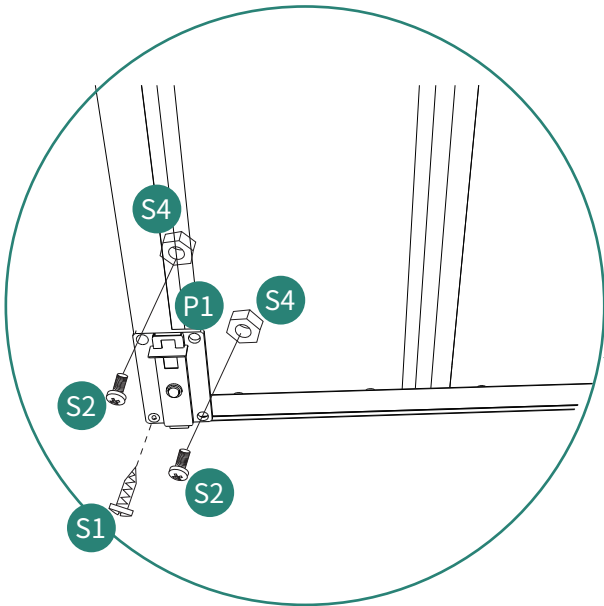
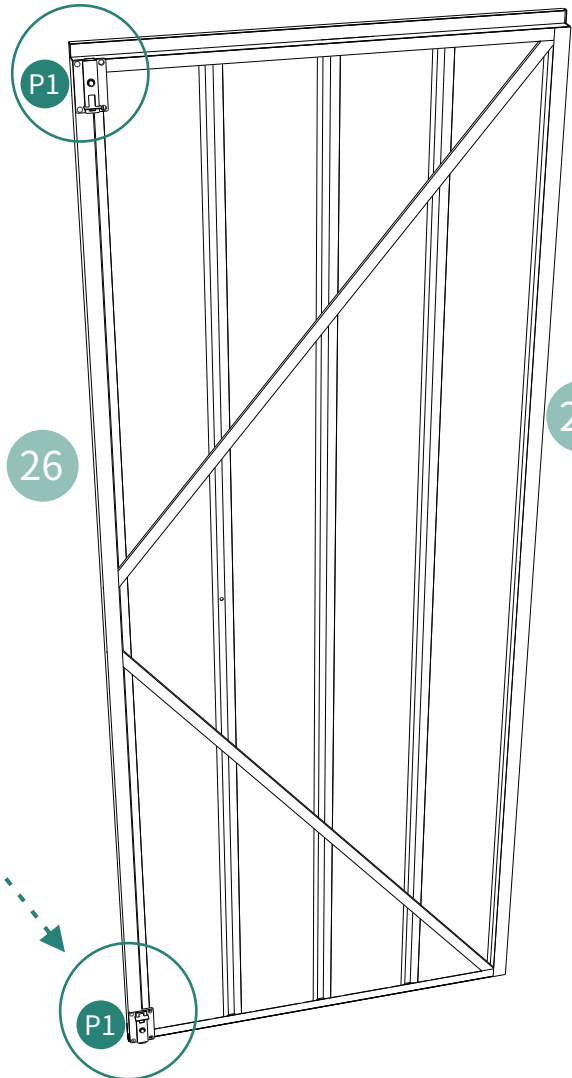
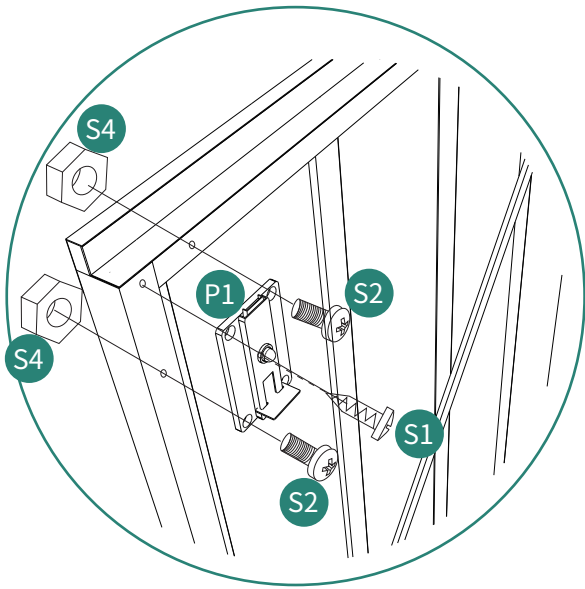

29



P2 1pc



P3 1pc

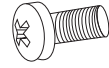

S2 6pcs



S4 6pcs

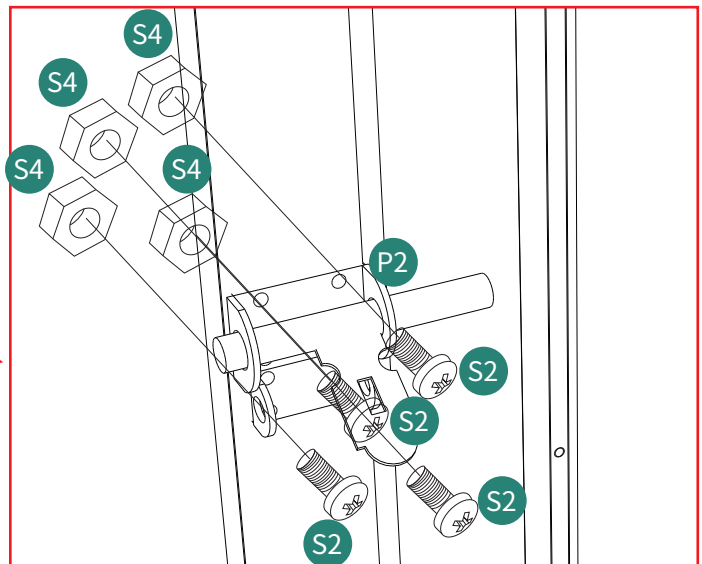
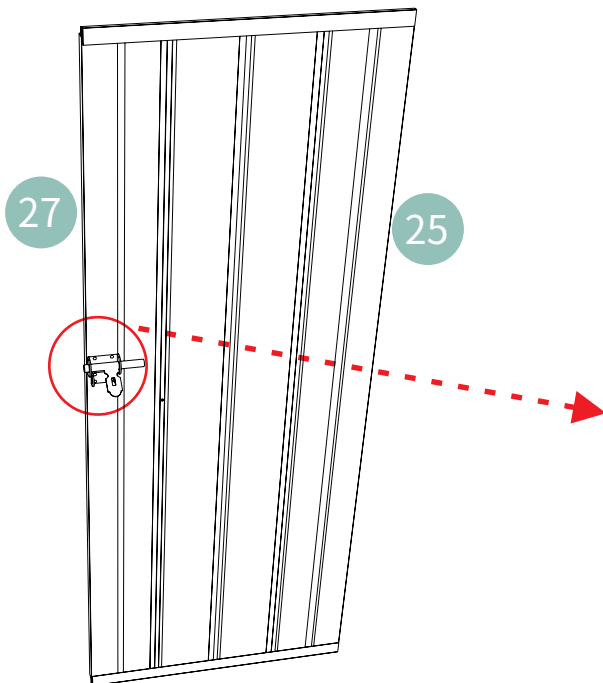
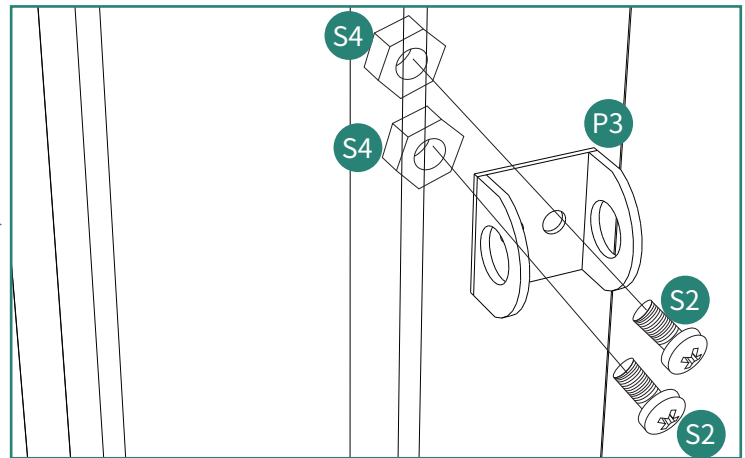
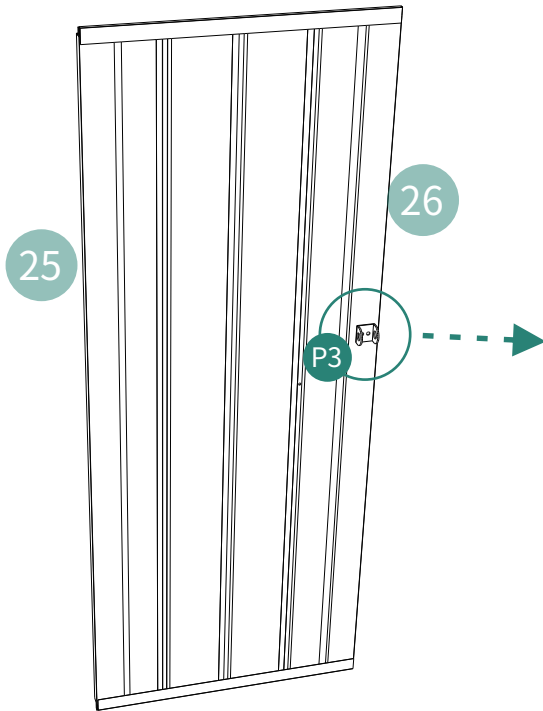

30

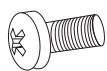

(S2) 12pcs (S4) 12pcs

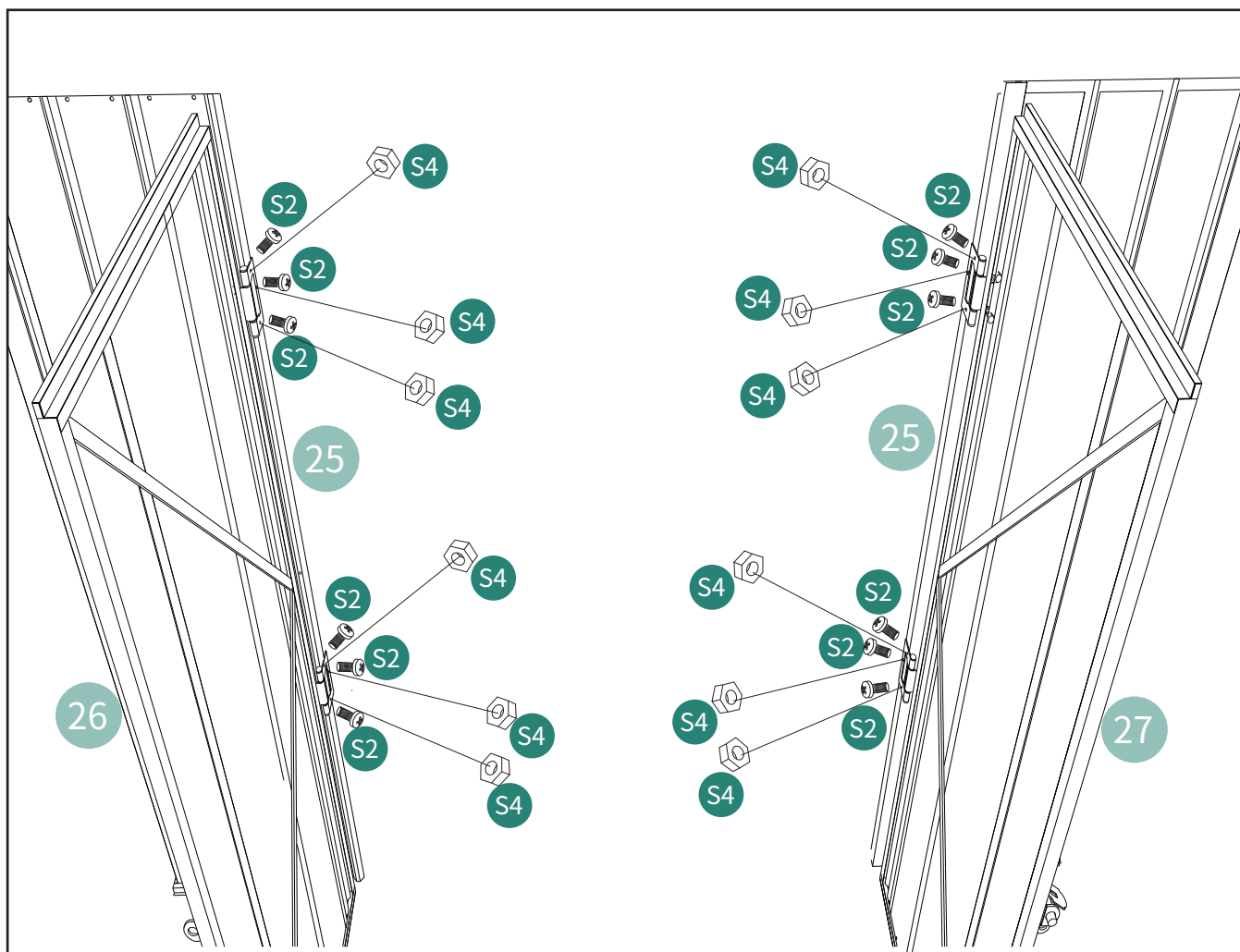

31



(M2) 1pc

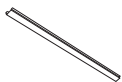

(22) 1pc



(23) 1pc



(S2) 2pcs



(S4) 2pcs

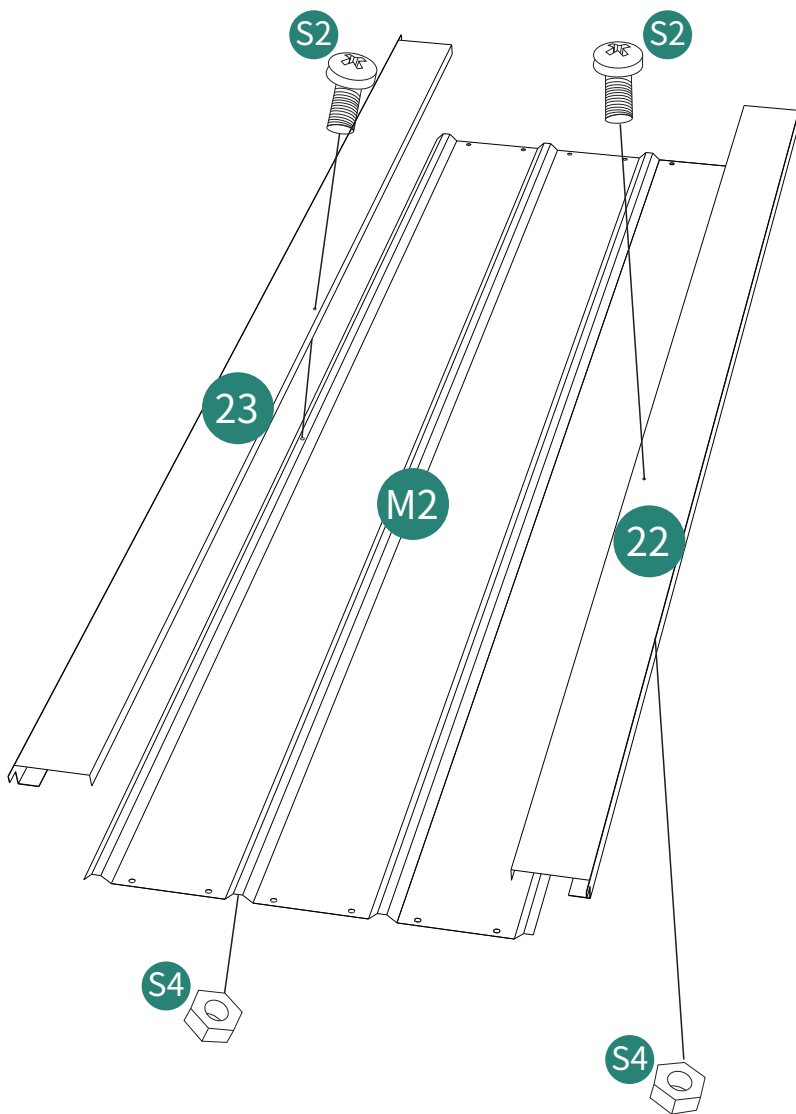

front side



32

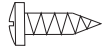

21 2pcs

S1 8pcs

S3 8pcs

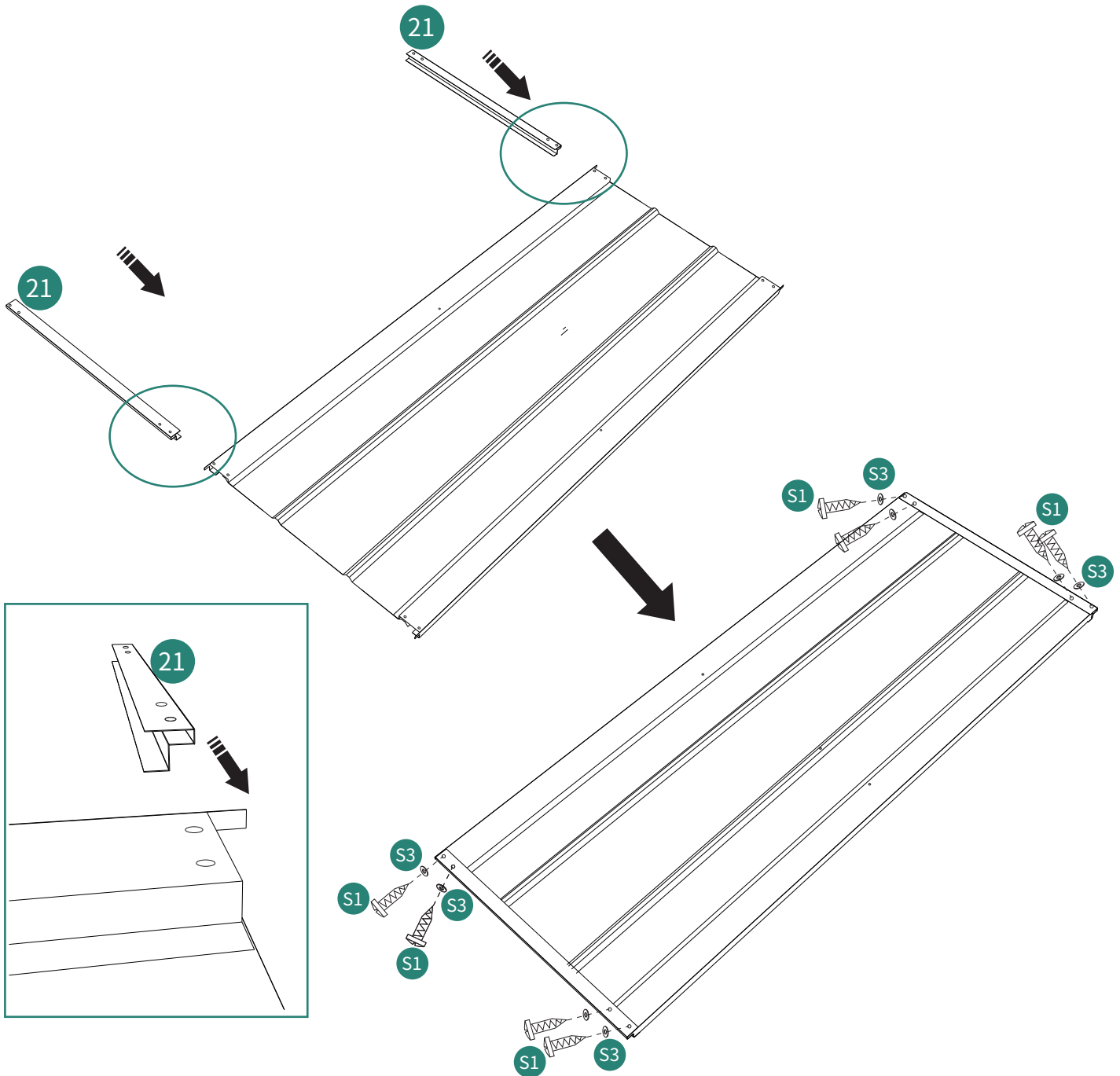

33



29 2pcs



P4 2pcs



S1 4pcs

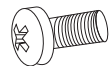

S2 6pcs



S4 6pcs

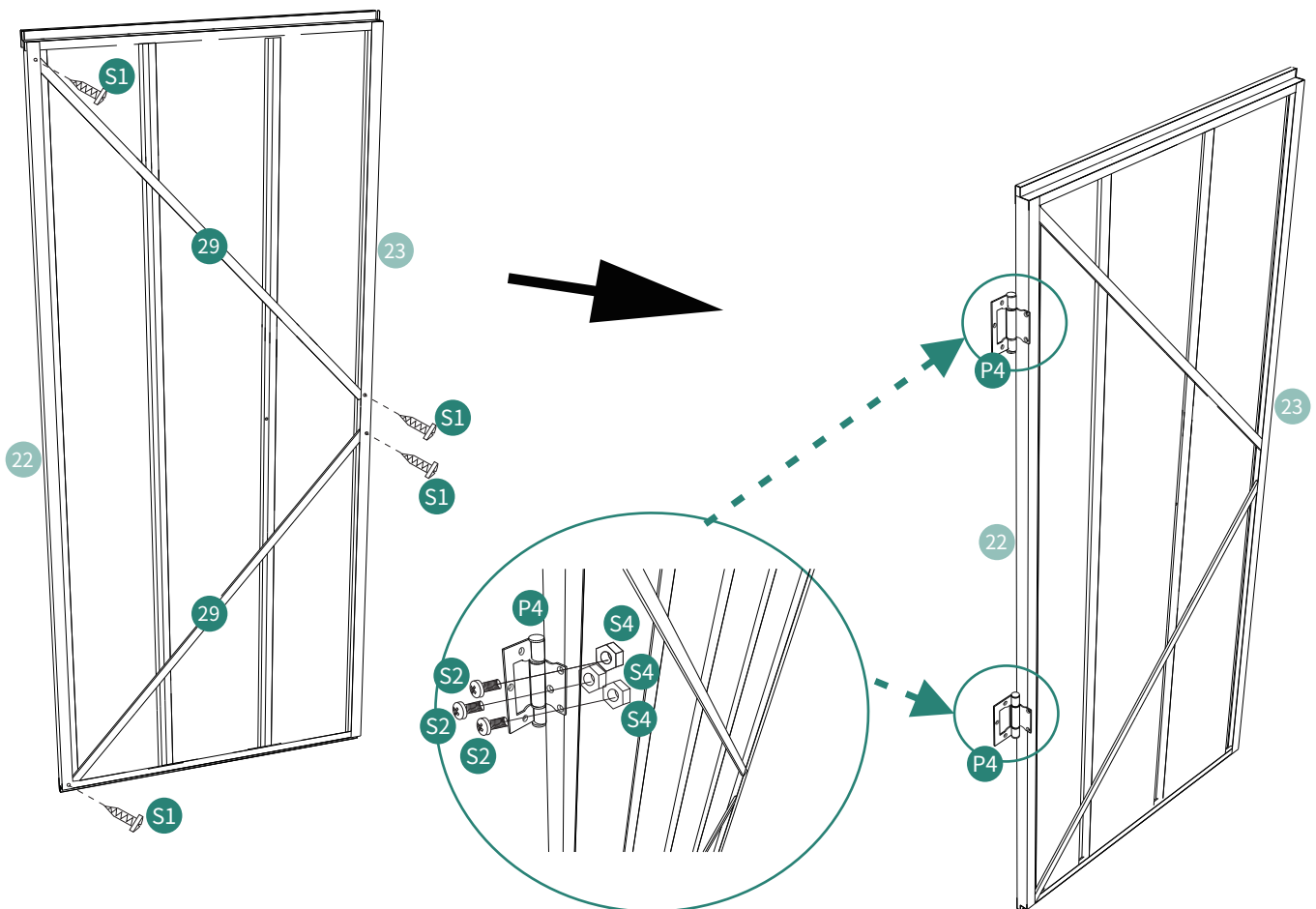

34

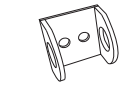

P3 1pc

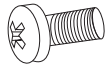

S2 2pcs



S4 2pcs

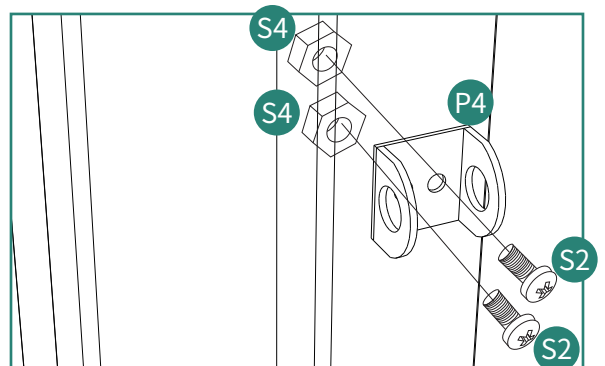
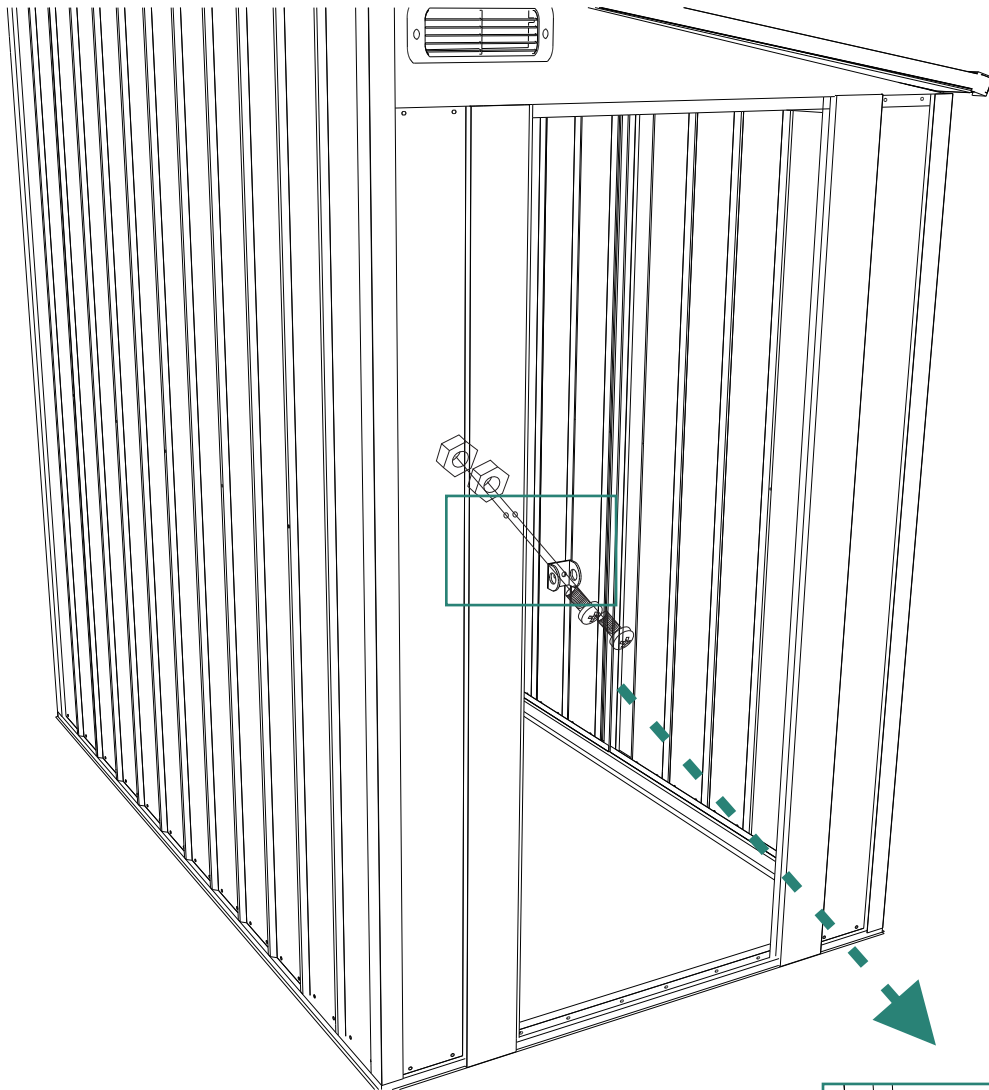

36

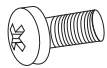

S2 6pcs



S4 6pcs

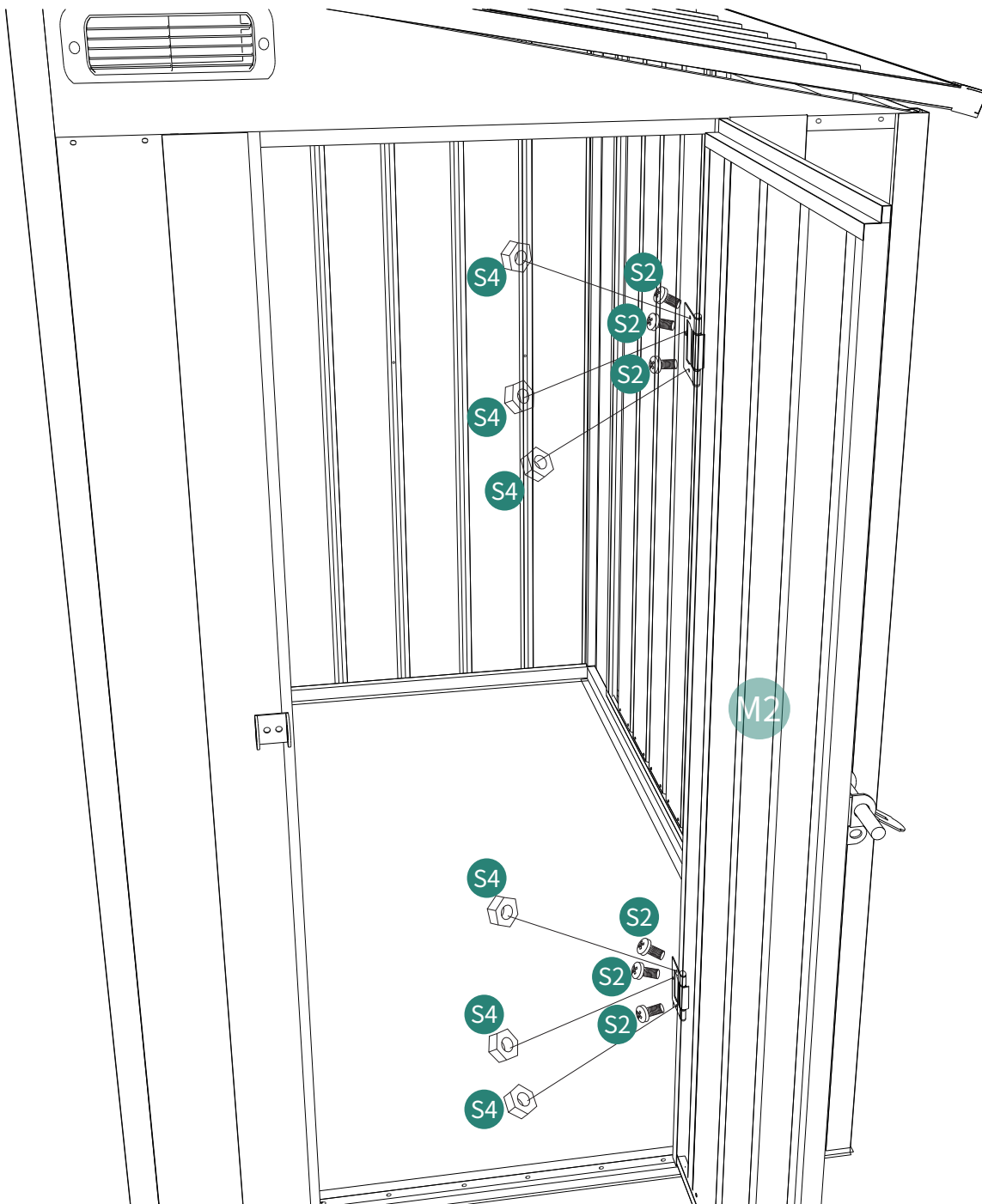

37

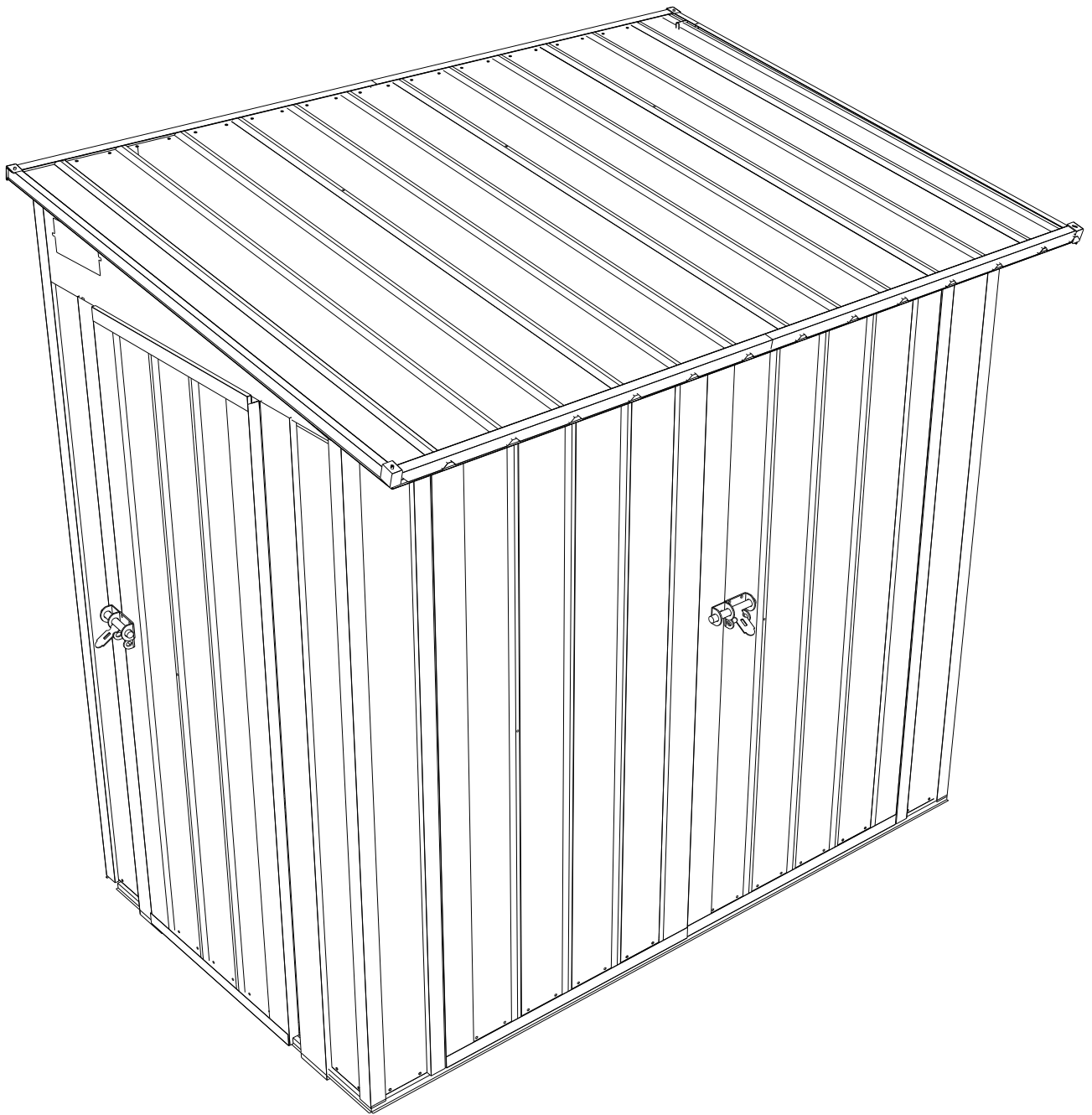

Installation Completed

HELP CENTER



Inquiry



Assembly issue



Missing parts

If you encounter any difficulties during assembly, please contact us.

Wenn Sie während der Montage auf Schwierigkeiten stoßen, kontaktieren Sie uns bitte.

Si vous rencontrez des difficultés lors du montage, veuillez nous contacter.

Se incontri difficoltà durante il montaggio, ti preghiamo di contattarci.

Si encuentras alguna dificultad durante el ensamblaje, por favor contáctanos.

DISCLAIMER

Manufacturer and seller expressly disclaim any and all liability for personal injury, property damage or loss, whether direct, indirect, or incidental, resulting from the incorrect attachment, improper use, inadequate maintenance, unapproved modification, or neglect of this product.

Der Hersteller und Verkäufer lehnen ausdrücklich jegliche Haftung für Personenschäden, Sachschäden oder Verluste ab, egal ob direkt, indirekt oder zufällig, die durch falsche Anbringung, unsachgemäßen Gebrauch, unzureichende Wartung, nicht genehmigte Änderungen oder Vernachlässigung dieses Produkts entstehen.

El fabricante y vendedor renuncian expresamente a toda responsabilidad por lesiones personales, daños materiales o pérdidas, ya sean directos, indirectos o incidentales, derivados de la incorrecta colocación, uso inadecuado, mantenimiento insuficiente, modificación no aprobada o negligencia de este producto.

Il produttore e il venditore declinano espressamente ogni responsabilità per lesioni personali, danni materiali o perdite, dirette, indirette o incidentali, derivanti dall'errato fissaggio, uso improprio, manutenzione inadeguata, modifica non autorizzata o negligenza di questo prodotto. Le fabricant et le vendeur déclinent expressément toute responsabilité en cas de blessures corporelles, de dommages matériels ou de pertes, qu'ils soient directs, indirects ou accessoires, résultant de la fixation incorrecte, de l'utilisation inappropriée, de l'entretien insuffisant, de la modification non approuvée ou de la négligence de ce produit.