

DRYWALL INSTALLATION KIT (OPTIONAL)

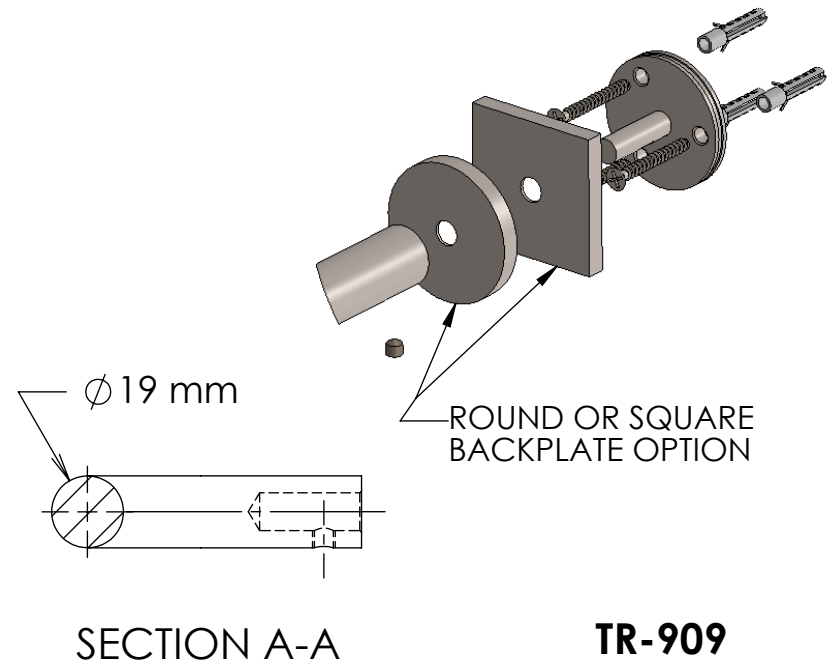

TR-909

