

INSTALLATION INSTRUCTION

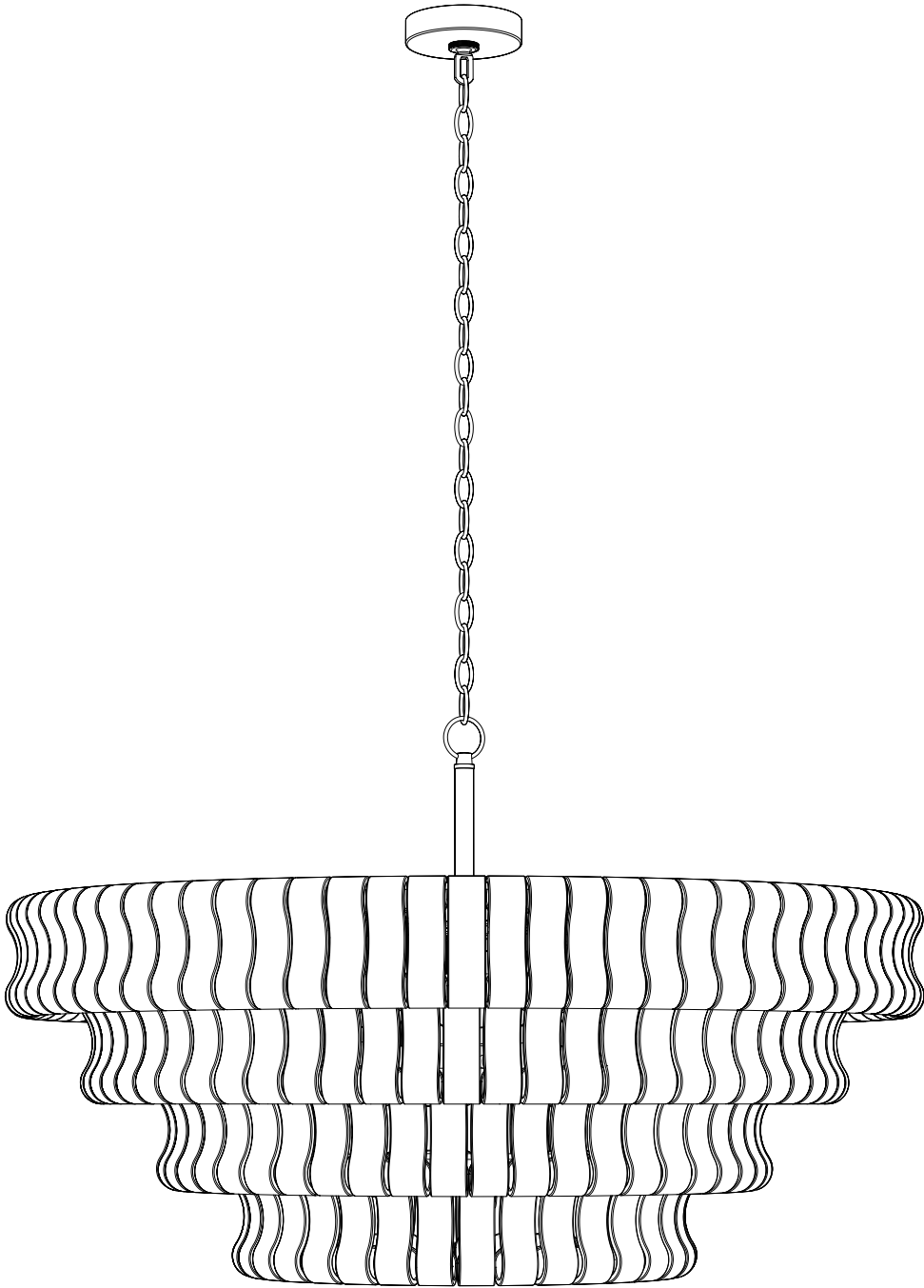

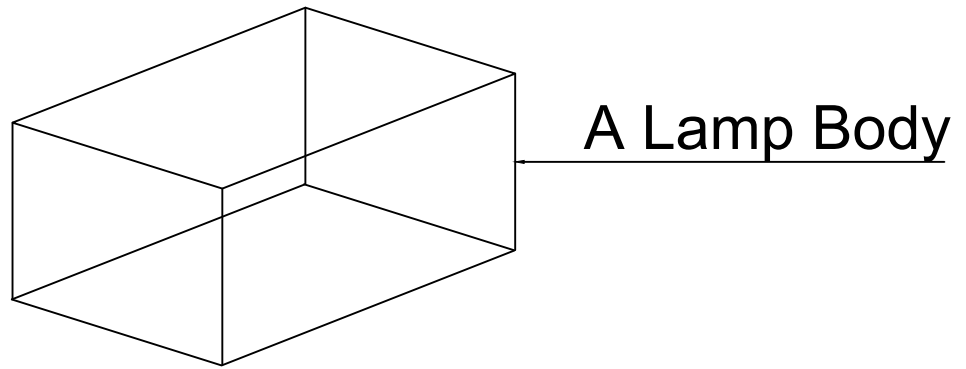

SAFETY INFORMATION

It is important to thoroughly read and understand the entire manual, before assembling, operating, or installing the product.

WARNING

- TURN OFF ELECTRICITY before installation, changing bulbs, or cleaning the light fixture. WARNING
- .This fixture requires 6 pieces E12 bulbs the maximum wattage for each bulb is 40W, please do not exceed the recommended wattage.

A QUALIFIED ELECTRICIAN IS RECOMMENDED FOR INSTALLATION.

.Do not use corrosive substances such as gasoline or alcohol disinfectants to wipe the lamps, otherwise it will damage the lamps.

PREPARATION

.Before installation, please make sure all the accessories are included

(refer to the package content), if there is any part missing, please contact us at the order page, we will arrange the replacement in a timely manner

.6 pieces of E12 bulbs(Max.40W) are required(not included in the product) For any questions or inquires, please feel free to contact us at the order page, our customer service team will reply ASAP.

Packaging diagram:

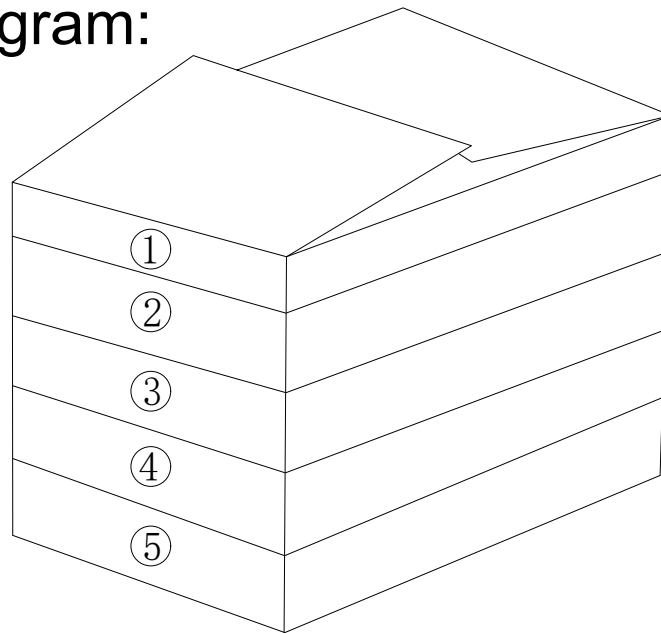

A

①

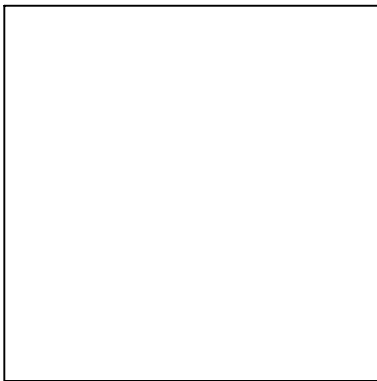

②

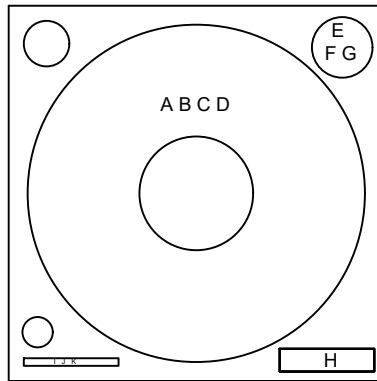

③

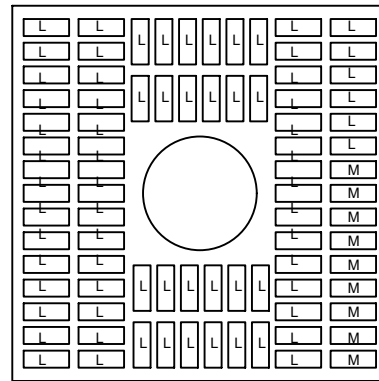

④

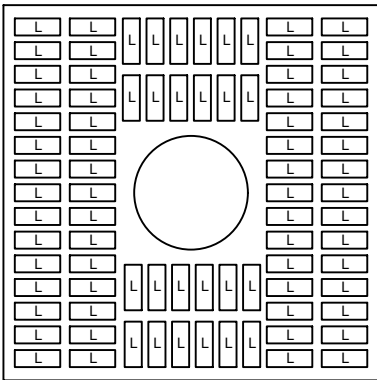

⑤

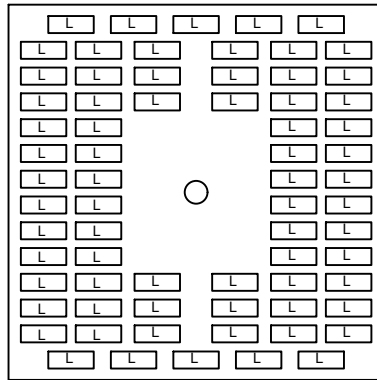

Inner Package Lists:

- 1, The first layer of Cover
- 2, The second layer Frame(A B C D)+Canopy(E)
+Chian(F G)+Derrick(H)+Connector(I J K)+
Part Kits
- 3, The third layer of glass pieces (L)
+light source(M)
- 4, The Fourth layer(L)
- 5, The Fifth Layer(L)

Accessory list

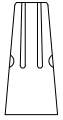

3pcs+2 Extra

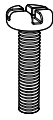

2pcs+2 Extra



2 Extra

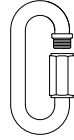

1 Extra



4pcs+1 Extra

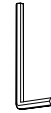

1pc+1 Extra



1pc+1 Extra

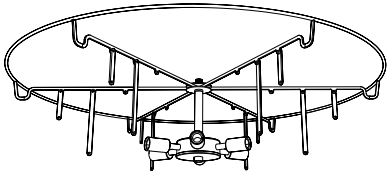

—A. Light Frame-1pc

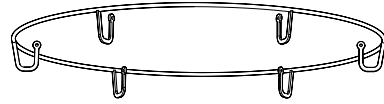

—B. Light Frame-1pc

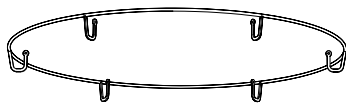

—C. Light Frame-1pc



—D. Light Frame-1pc

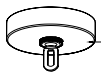

—E. Canopy-1pc

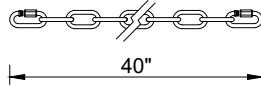

—F. Long Chain-2pcs

40"

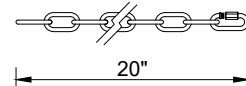

—G. Short Chain-1pc

20"

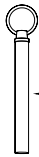

—H. Boom-1pc



—I. Short Connector-6pcs+1 Extra

2.5"

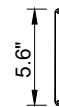

—J. Middle Connector-6pcs+1 Extra

5.6"

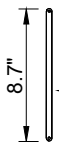

—K. Long Connector-6pcs+1 Extra

8.7"

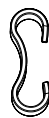

—L. Glass Piece-225pcs+5 Extra



—M. Light Source-6pcs+2 Extra



Installation instruction

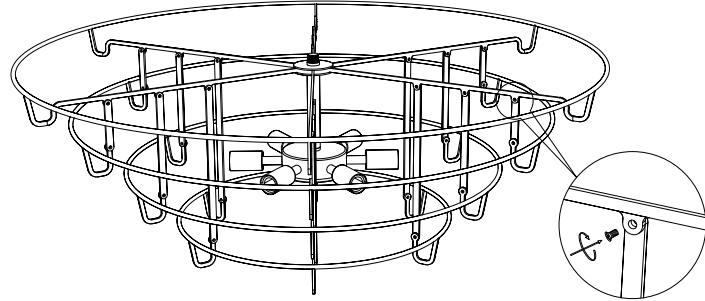
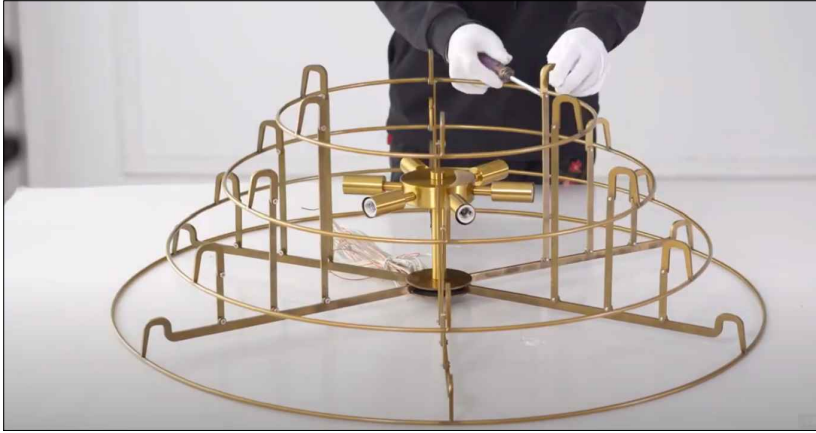

- ① Find FrameA FrameB FrameC FrameD from Lists, Use ConnectorI ConnectorJ ConnectorK to connect the Frame.

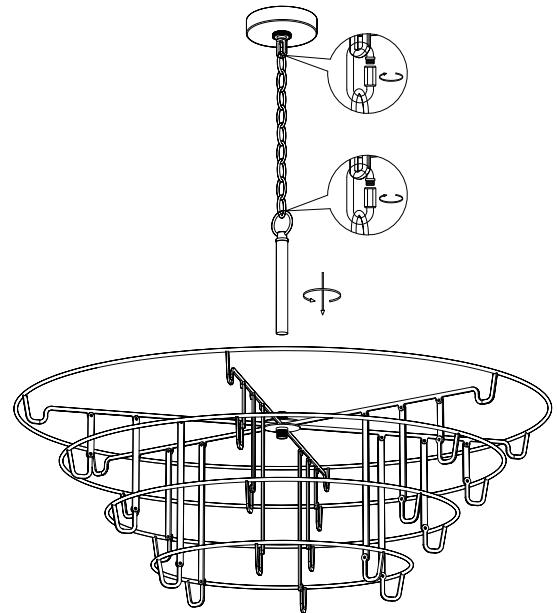
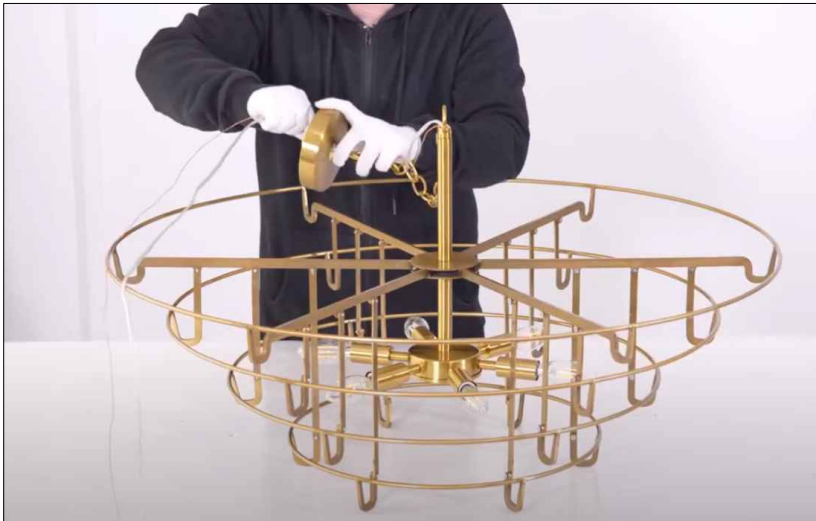

- ② The power cord is mounted on the light body through the boom (H). Latch the two ends of the chain to connect the boom (H) to the canopy (E) and plug the power cord into the roof cover (E) on top of the light body.

Installation instruction

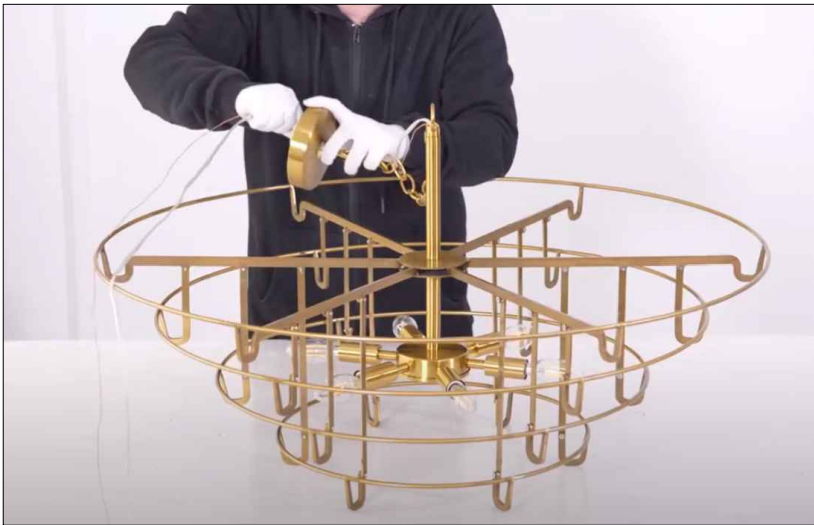

3

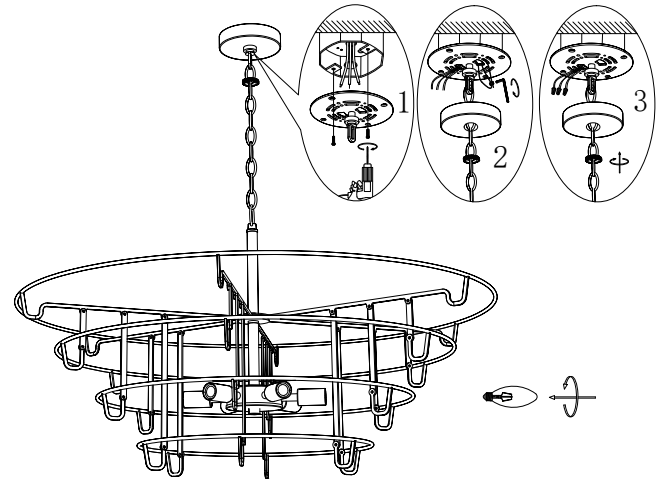

- (1), take out the wall plate and the wall with the explosion screws for linking.
- (2), the lamp body steel wire through the holes in the hanging plate with iron fixed
- (3), the main power supply line and the main line of the lamp body links, fixed ceiling cover fixed
- (4), Screw 6 E12 light sources into the head.

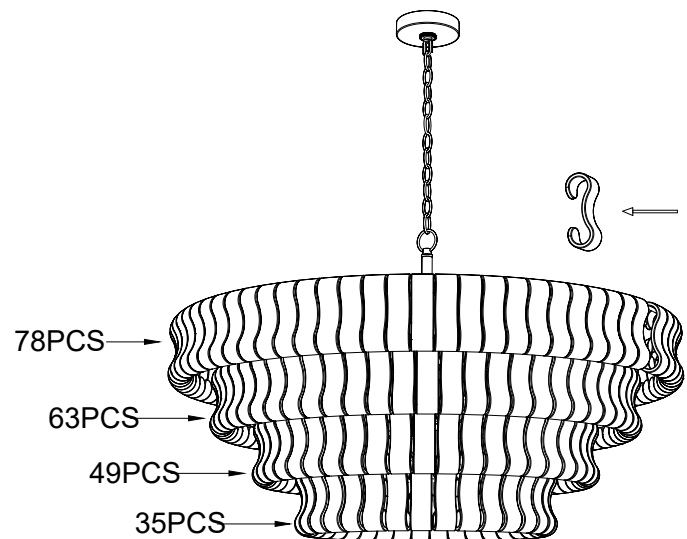

- 4 The glass pieces are hung on the body of the lamp in the quantities labeled for each layer.

Before assembly:

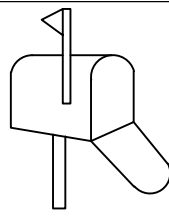

★Email:
Lighting@yxtservice.com.
If you have any questions,
please feel free to contact us.
Wishing you a pleasant day!

★ Please read all the instructions carefully.

★ ★ ★ ★ ★
5 star rating

★ Keep the instruction manual for future reference

Thank you

★ Separate and list all parts and hardware



★ Read each step carefully and follow the correct installation order.

★ To avoid losing any parts during assembly, we recommend not moving the lamp before completing the assembly. Always place the product on a flat, firm, and stable surface.

★ Keep all small parts and packaging materials of this product away from babies and children, as they may cause serious injury.

★Product Parameters:

light: E12*6 watt: 4W (single) color temperature: 2700K

Installation video and product website:

YouTube URL: [YouTube URL: https://www.youtube.com/watch?v=Zu1T6RLR4gQ](https://www.youtube.com/watch?v=Zu1T6RLR4gQ)

Scan the QR code to view:



Warranty

Our dedicated customer service team is available 24 hours a day to assist you. If you have any questions or concerns, we guarantee a response within 24 hours. During the warranty period, if you encounter any problems or need assistance, please don't hesitate to reach out to us via email. To ensure a swift and accurate resolution, kindly provide your order ID and detailed information regarding the issue.

Important Note: Please use this light fixture only for its intended purpose and avoid retrofitting or remodeling it. The warranty does not cover failures caused by third-party products or natural disasters.

★ If your product has any issues upon receipt, please:

1. Provide your order number.
2. Attach a photo or video of the issue.
3. Contact us through the platform's customer service.