

Assembly Instructions

CAUTION: You must read this before you proceed.

CHAIR

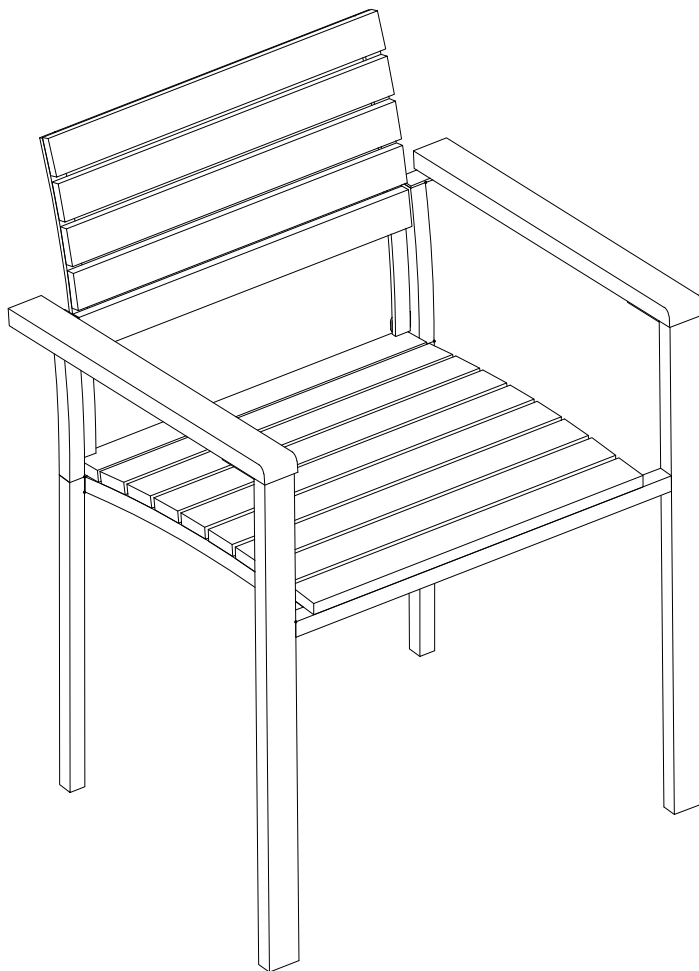

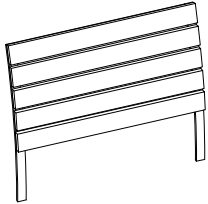
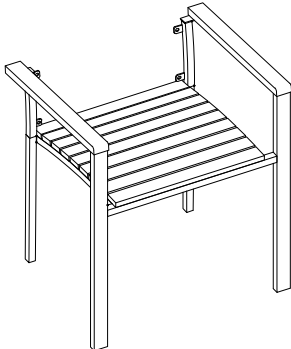

Caution: This Chair is NOT a TOY.
Keep your child/children at bay during the assembly process.
Whenever lifting the Chair and to prevent damage to the Chair two adults are needed to execute this action.

Parts List

Label	Picture	Description	QTY
A		Backrest Panel	1
B		Seat Frame	1

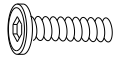
Hardware

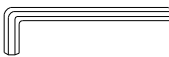
Label	Picture	Description	Qty
①		Bolt (M6 x 12mm)	5
②		Washers (M6/16 x 1mm)	5
③		Allen Key	1

Assembly Preparation

Before Beginning Assembly:

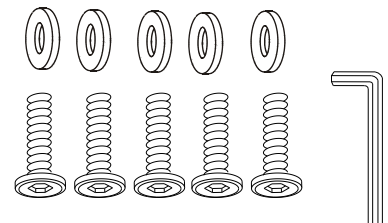
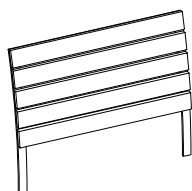
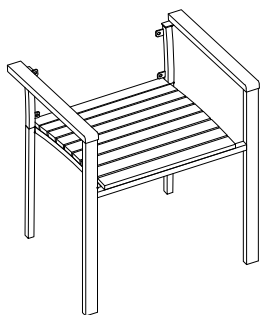

Read instructions, cover to cover.



Have 2 adults on hand for assembly.



Do not assemble on flooring or carpet.



Assemble on a clean non-marring surface (packing foam).



Save all packaging until finished.

Assembly Steps

OVERVIEW

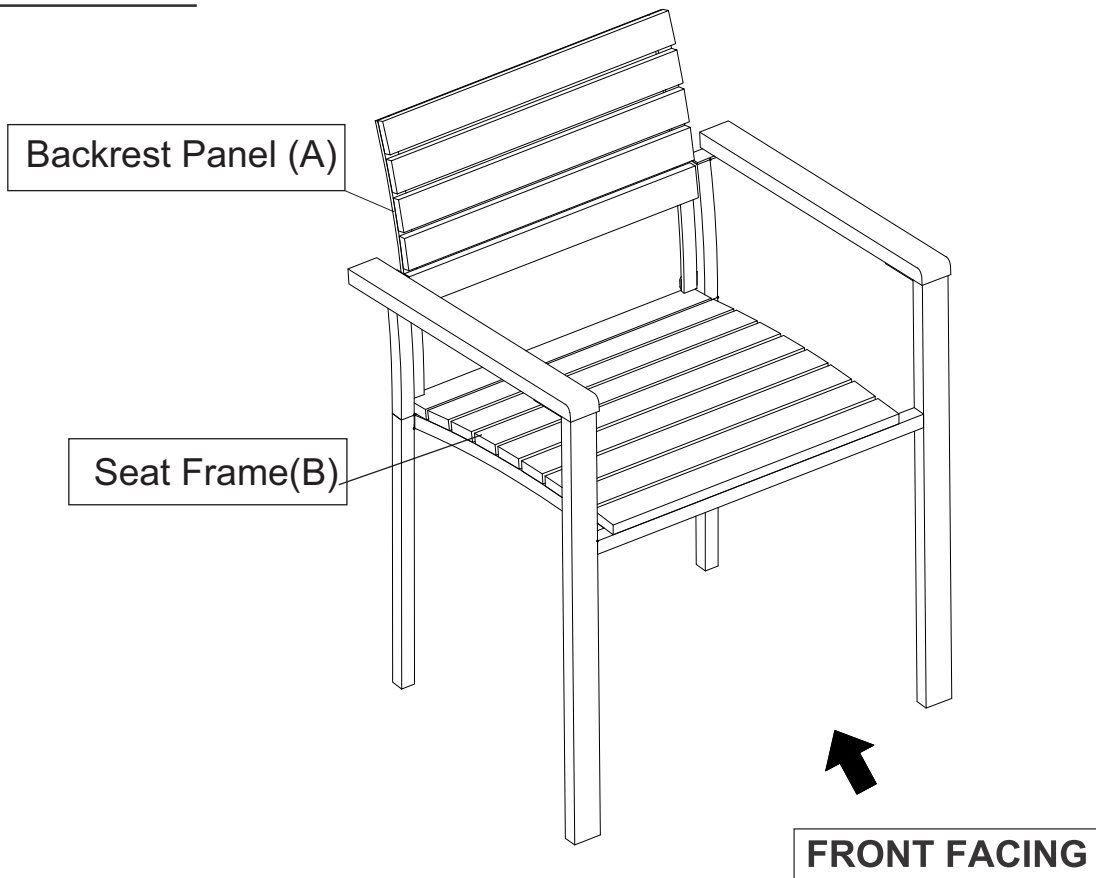

This Chair has multiple parts and may require up to some 15 minutes to assemble. To give you an overview of the chair parts, the above picture is to help you put the various parts into perspective. Please read through the instructions below to familiarise yourself with the parts and steps before assembly.

Step 1

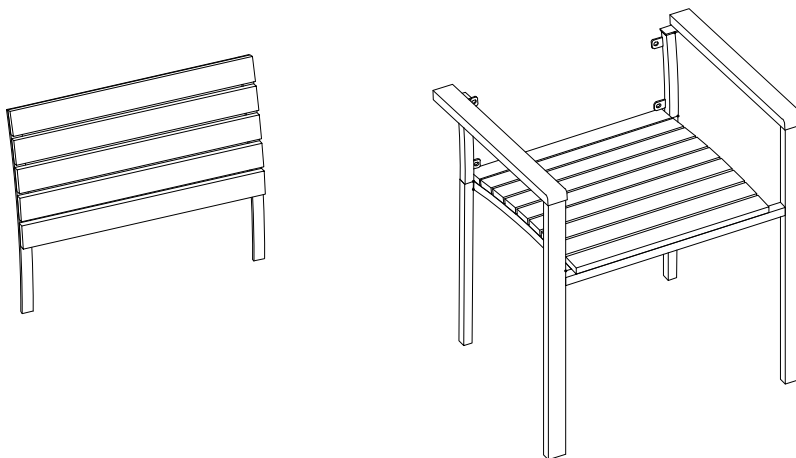

Unpack and place all parts on a clean, non-marring surface.

Assembly Steps

Step 2

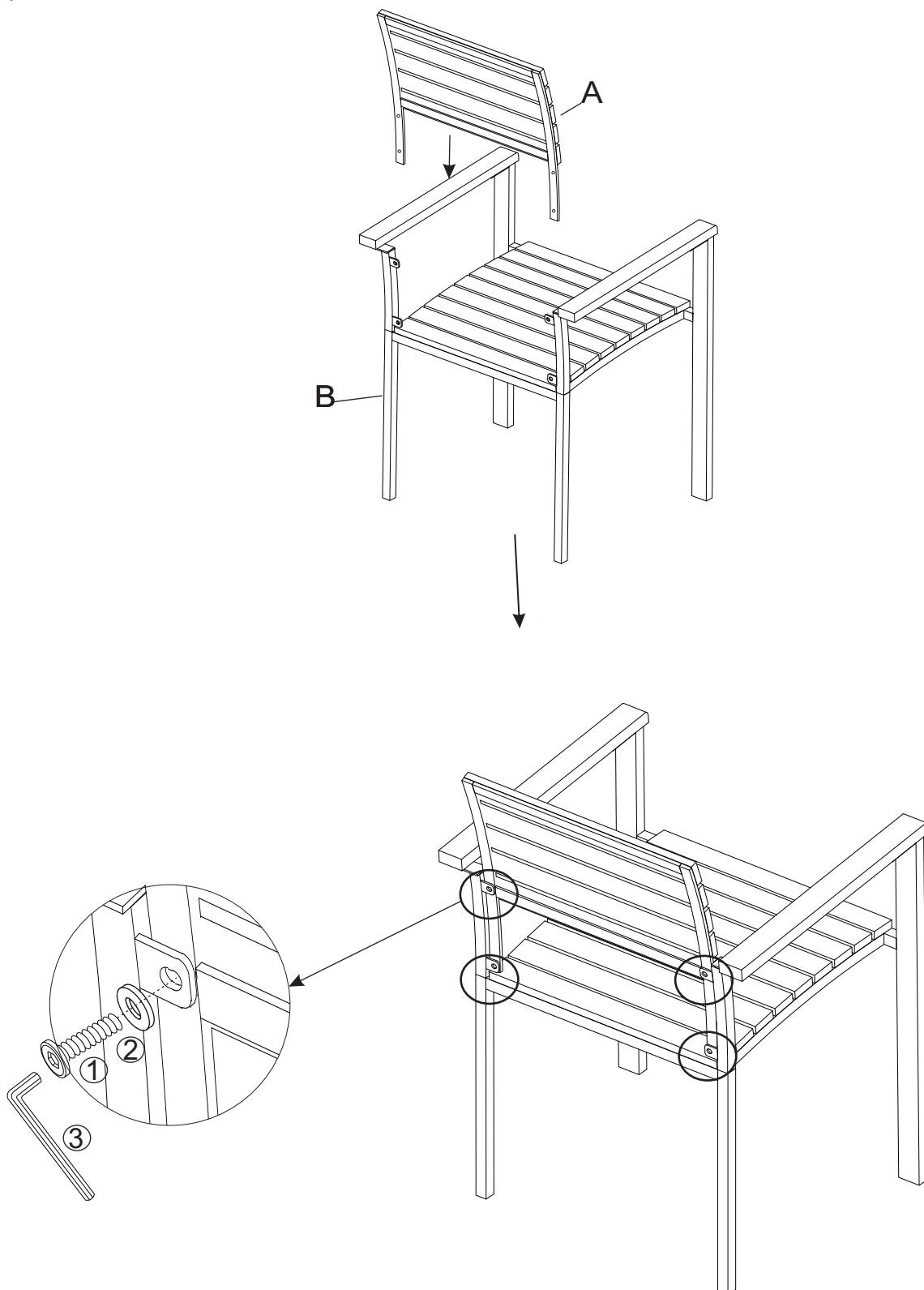

Position Backrest Panel (A) to the Seat Panel (B) as shown in picture above. Then attach Backrest Panel (A) to Seat Panel (B) by using Bolt (①) , Flat Washers (②) and Allen Key (③).

Do not fully tighten the Bolts.





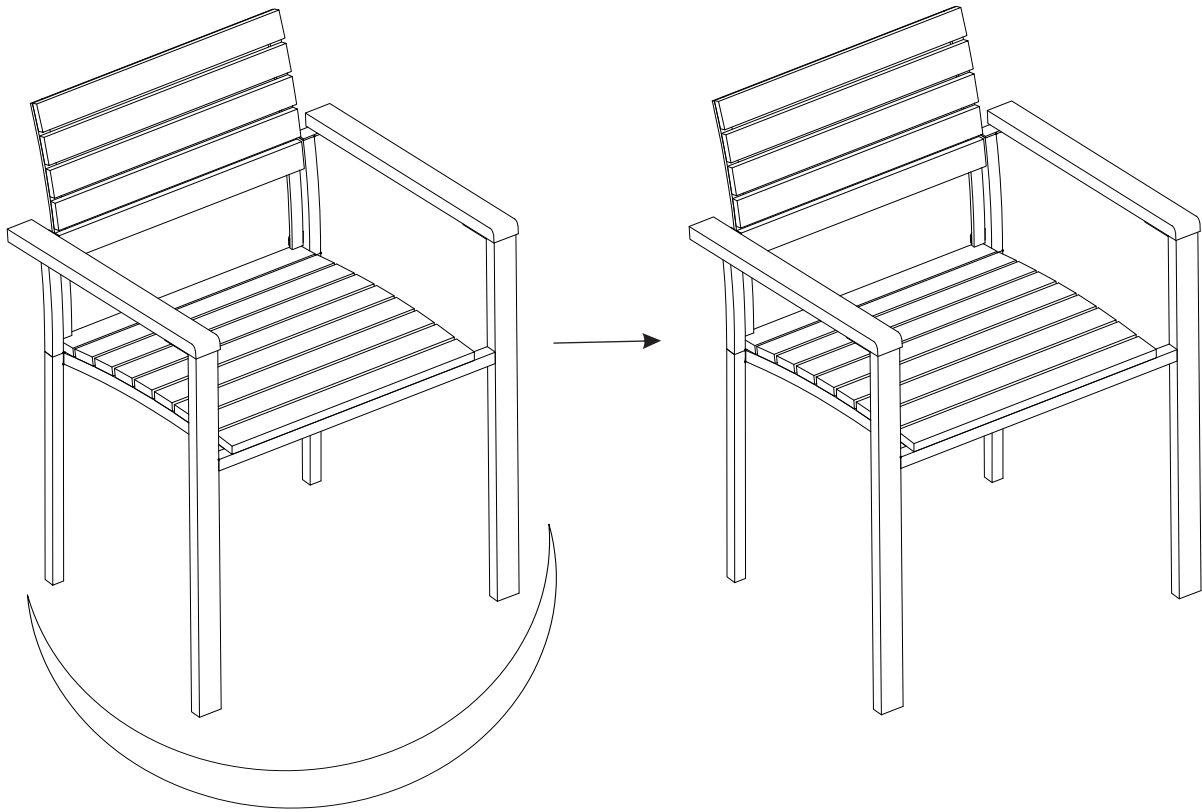



Assembly Steps

Step 3



Exert pressure floorwards, onto the Chair with both your hands.
This pressure will help the Legs and Chair reach full alignment status.
Check for wobbles on a LEVEL surface.
If no wobbles are found proceed to tighten Bolts in a sequential manner, until evenly secured.
When tightening Bolts tighten sequentially.
Do not tighten any Bolt fully and then move on towards the next one.
If there are still wobbles, loosen Bolts and excute the same above process.
Your Chair is ready for use.
This Chair can only be used on a flat, level surface.

Care & Maintenance

-  Do not put hot items directly on furniture surface.
-  Do not clean furniture with harsh cleansers or polish.
-  To obtain the longest lifespan of your outdoor products, minimizing exposure to direct sunlight is recommended.
-  Children should not climb or jump the furniture.
-  Do not write on furniture without a padded barrier to protect the surface.
-  To obtain the longest lifespan of your outdoor products, avoid extended and lengthy exposure to rain, snow, and direct sunshine. whenever possible cover the product and/or place under patio or awnings.
-  Not for commercial use. For residential use only.
-  Stains may be removed with mild soap solution and damp cloth.
-  Dust and pick-up spills using a clean, non-colored, lint-free cloth.