

Assembly Instructions

CAUTION : You must read this before you proceed

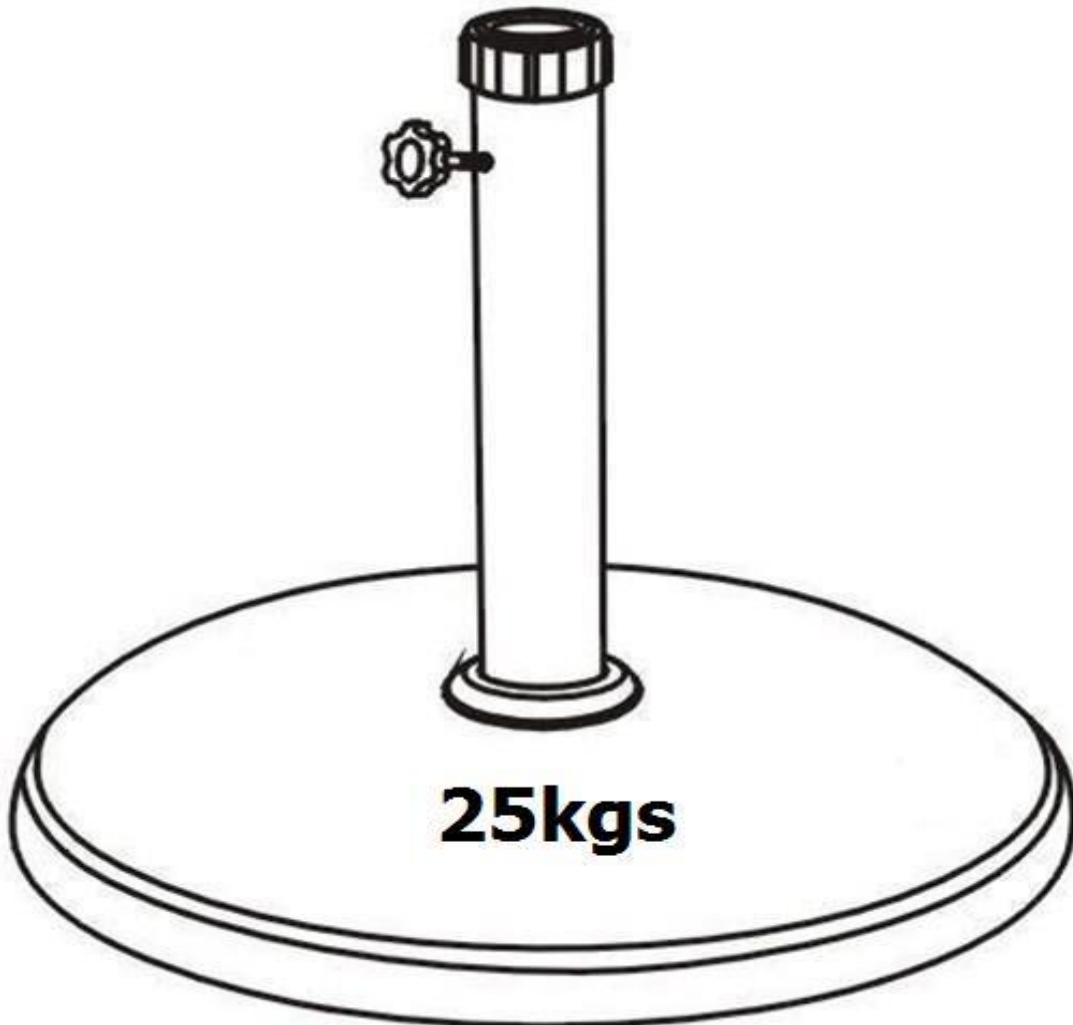





Remind: Umbrella open diameter max. 8 feet

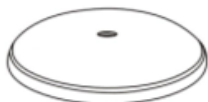

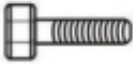
Umbrella Base Weight : 55 lbs

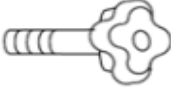
Parts List

Label	Picture	Description	QTY
A		Umbrella Base	1

B		Washer	1
C		Locking Bolt	1
D		Decorative Ring	1
E		Support Pole	1
F		Adjustable Screw	1
G		Cap	1
H		Adapter for 38mm Pole	1
I		Adapter for 48mm Pole	1

Assembly Preparation

Before Beginning Assembly:



- Read instructions, cover to cover-



- Have 2 adults on hand for assembly-



- Do not assemble on flooring or carpet-



- Assemble on a clean non-marring surface (packing foam)-



- Save all packaging until finished-

WARNING : AVOID CHOKING / CHOKING HAZARDS : Do not allow children to play with plastic wraps and / any small parts in this package.

Notice: As a safety precaution, when umbrella is not in use please turn down umbrella. Remove Umbrella from this base and store in safe location

ATTENTION : This Umbrella Base is exclusively recommended to be used together under a table with the matching umbrella with diameter of 8 feet. The matching Support Pole diameter : 38mm - 48mm.

Assembly Steps

Step 1

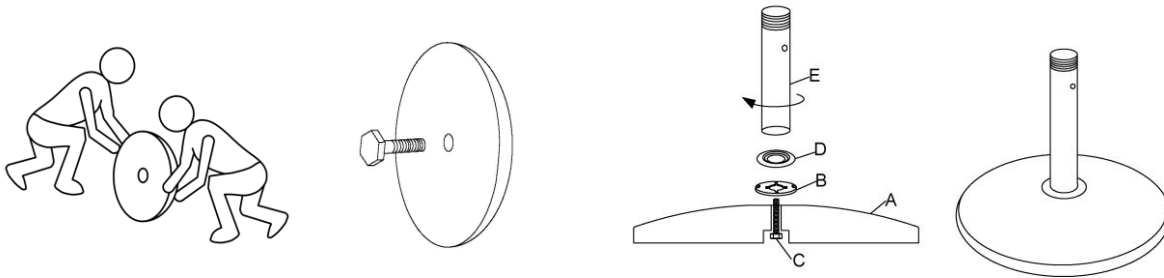

This is a 2-person team assembly product.

Tilt the Umbrellas Base to its side as pictured.

Put the Locking Bolt (C) through the base from the hole on the bottom.

Screw the Washer(B)to fastening the Locking Bolt(C).

Adding the Decorative Ring (D) onto the Washers (B).

Screw the Support Pole (E) onto the base.

Step 2

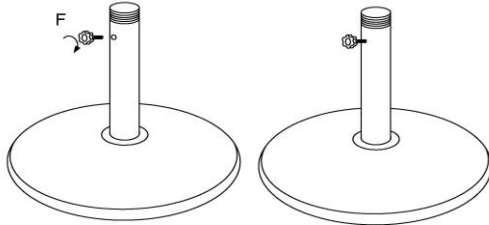

Screw the Adjustable Screw (F) into the Support Pole(E).

Step 3

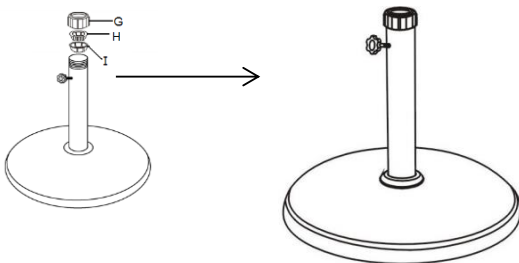



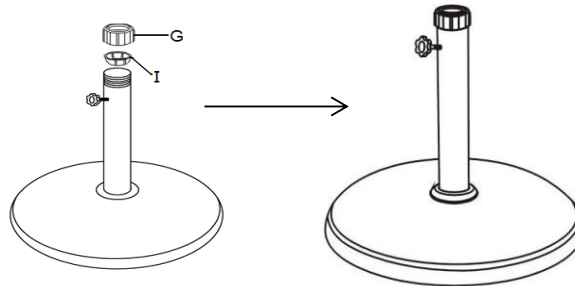















For the Umbrella Pole with diameter as 38mm, use Dia. 38mm Adapter (H) & Dia. 48mm Adapter (I) added together, insert the Dia. 48mm Adapter (I) into the Support Pole (E) first, and then put the Dia. 38mm Adapter (H) onto the Dia. 48mm Adapter(I), Turn the Cap(G) onto the Support Pole(E) to hold the Adapters in place.
The Umbrella Base is fully assembled and ready for use.



For the Umbrella Pole with diameter as 48mm, use the Dia. 48mm Adapter (I) only, insert the Dia. 48mm Adapter (I) into the Support Pole (E), Turn the Cap(G) onto the Support Pole(E) to hold the Adapters in place.
The Umbrella Base is fully assembled and ready for use.

Care & Maintenance

-   ● Do not put hot items directly on furniture surface
 -   ● Do not clean furniture with harsh cleansers or polish.
 -   ● To obtain the longest lifespan of your outdoor products, minimizing exposure to direct sunlight is recommended.
 -   ● Children should not climb or jump on the furniture.
 -   ● Do not write on furniture without a padded barrier to protect the surface.
 -   ● To obtain the longest lifespan of your outdoor products, avoid extended and lengthy exposure to rain, snow, and direct sunshine. Whenever possible cover the product and /or place under patio or awnings.
 -   ● Not for commercial use. For residential use only .
 -   ● Stains may be removed with mild soap solution and damp cloth.
-
-   ● Dust and pick-up spills using a clean, non-colored, lint-free cloth .