

LIKIMIO Installation Instruction

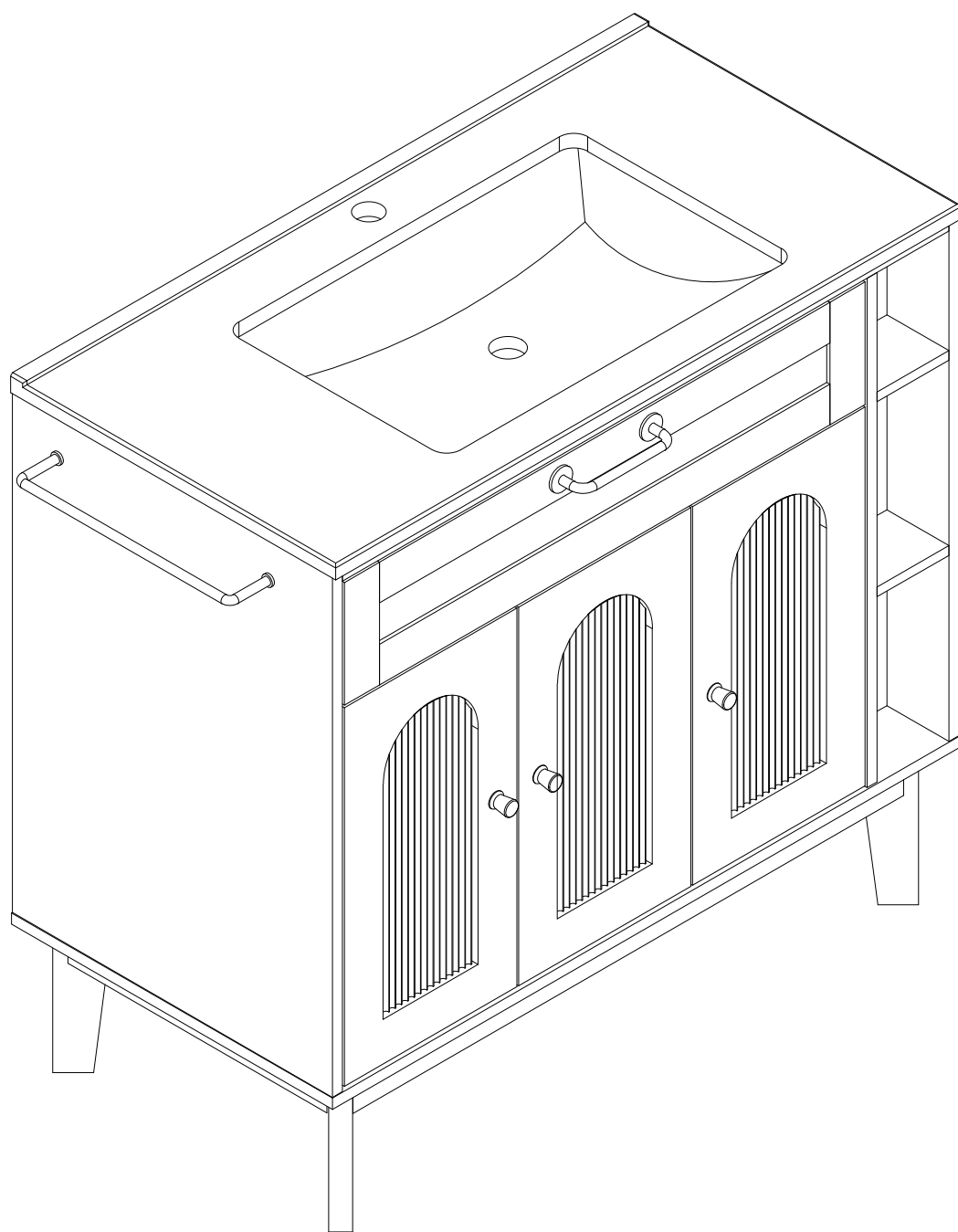

EN

1. PRECAUTIONS

When moving furniture, do not drag, always lift.

Check all fixings regularly to ensure that they are not loose and retighten if necessary.

Handle or move furniture with care, as carelessness may cause damage or injury.

Furniture can be dangerous if not installed correctly.

No liability will be assumed for damage or injury caused by improper installation or assembly.

Keep these instructions for future reference.

2. CARE AND MAINTENANCE

Dust regularly with a clean, soft, dry cloth.

Do not use any abrasive or acidic products. Never use cleaning solvents.

For professional cleaning only.

3. WARNING

(1) Use the provided wall mount.

(2) Never allow children to climb or hang on drawers, doors or shelves.

(3) Place the heaviest items in the drawers or shelves below.

(4) Do not place a television or other heavy objects on top of this product unless it is specifically designed to accommodate.

(5) Do not open more than one drawer at a time.

Accessory devices come with your product; however, you need to find the right fixtures for your wall type. If in doubt, consult a qualified professional.

Always make sure that the wall you are drilling into is free of hidden electrical wires, water pipes, and gas pipes.

(6) This product contains small parts. Keep all small parts out of reach of children. If swallowed or inhaled, these small parts can be fatal.

(7) Keep plastic bags out of reach of children to avoid potential hazards such as suffocation.

4. INSTALLATION GUIDE

Assembly is to be performed by competent adults only.

During assembly, children should stay away from the product as there may be a risk of injury.

Do not use this item if any parts are missing or damaged.

DE

1. HINWEISE

Ziehen Sie beim Bewegen von Möbeln nicht daran, sondern heben Sie sie immer an.

Überprüfen Sie regelmäßig alle Befestigungen auf Lockerheit und ziehen Sie diese gegebenenfalls nach.

Seien Sie beim Umgang mit oder beim Bewegen von Möbeln vorsichtig, da Unachtsamkeit zu Schäden oder Verletzungen führen kann.

Möbel können gefährlich sein, wenn sie nicht richtig installiert werden.

Für Schäden oder Verletzungen, die durch unsachgemäße Installation oder Montage entstehen, wird keine Haftung übernommen.

Bewahren Sie diese Anweisungen zum späteren Nachschlagen auf.

2. PFLEGE UND WARTUNG

Stauben Sie regelmäßig mit einem sauberen, weichen und trockenen Tuch ab.

Verwenden Sie keine Scheuermittel oder säurehaltigen Produkte. Verwenden Sie keine Reinigungslösungsmittel.

Nur für die professionelle Reinigung.

3. WARNUNG

(1) Verwenden Sie die mitgelieferte Wandhalterung.

(2) Erlauben Sie Kindern niemals, auf Schubladen, Türen oder Regale zu klettern oder sich daran festzuhalten.

(3) Platzieren Sie die schwersten Gegenstände in unteren Schubladen oder auf Regalen.

(4) Stellen Sie keinen Fernseher oder schwere Gegenstände auf die Oberseite dieses Produkts, es sei denn, es ist speziell dafür konzipiert, solche Lasten aufzunehmen.

(5) Öffnen Sie nicht mehr als eine Schublade gleichzeitig.

Die Befestigungsvorrichtung ist im Lieferumfang Ihres Produkts enthalten. Sie müssen jedoch die passende Halterung für Ihren Wandtyp finden. Im Zweifelsfall wenden Sie sich an einen qualifizierten Fachmann.

Stellen Sie immer sicher, dass in der Wand, in die Sie bohren, keine versteckten Strom-, Wasser- und Gasleitungen vorhanden sind.

(6) Dieses Produkt enthält Kleinteile. Bewahren Sie alle Kleinteile außerhalb der Reichweite von Kindern auf. Diese Kleinteile können beim Verschlucken oder Einatmen tödlich sein.

(7) Bewahren Sie Plastiktüten außerhalb der Reichweite von Kindern auf, um mögliche Gefahren wie Erstickung zu vermeiden.

4. INSTALLATIONSANLEITUNG

Die Montage darf nur von fachkundigen Erwachsenen durchgeführt werden.

Kinder sollten während der Montage vom Produkt ferngehalten werden, da Verletzungsgefahr besteht.

Verwenden Sie diesen Artikel nicht, wenn Teile fehlen oder beschädigt sind.

FR

1. PRÉCAUTIONS

Lorsque vous déplacez des meubles, ne les traînez pas, soulevez-les toujours. Vérifiez régulièrement toutes les fixations pour vous assurer qu'elles ne se sont pas desserrées et resserrez-les si nécessaire.

Soyez prudent lorsque vous manipulez ou déplacez des meubles, car une négligence peut entraîner des dommages ou des blessures.

Les meubles peuvent être dangereux s'ils ne sont pas installés correctement.

Aucune responsabilité ne sera assumée pour les dommages ou blessures résultant d'une installation ou d'un assemblage incorrect.

Conservez ces instructions pour référence ultérieure.

2. ENTRETIEN ET MAINTENANCE

Dépoussiérer régulièrement avec un chiffon propre, doux et sec.

N'utilisez pas de produits abrasifs ou acides. N'utilisez pas de solvants de nettoyage.

Pour nettoyage professionnel uniquement.

3. AVERTISSEMENT

(1) Utilisez le support mural fourni.

(2) Ne laissez jamais les enfants grimper ou s'accrocher aux tiroirs, aux portes ou aux étagères.

(3) Placez les articles les plus lourds dans les tiroirs inférieurs ou sur des étagères.

(4) Ne placez pas de téléviseur ou d'autres objets lourds sur ce produit, à moins qu'ils ne soient spécifiquement conçus pour les accueillir.

(5) N'ouvrez pas plus d'un tiroir à la fois.

L'équipement de fixation est fourni avec votre produit ; Cependant, vous devrez trouver le luminaire approprié à votre type de mur. En cas de doute, consultez un professionnel qualifié.

Assurez-vous toujours que le mur dans lequel vous percez est exempt de fils électriques, de conduites d'eau et de conduites de gaz cachés.

(6) Ce produit contient de petites pièces. Gardez toutes les petites pièces hors de portée des enfants. Ces petites pièces peuvent être mortelles en cas d'ingestion ou d'inhalation.

(7) Conservez les sacs en plastique hors de portée des enfants pour éviter tout risque d'étouffement.

4. GUIDE D'INSTALLATION

L'assemblage doit être effectué uniquement par des adultes compétents.

Les enfants doivent être tenus à l'écart du produit pendant le montage car il existe un risque de blessure.

N'utilisez pas cet article si des pièces sont manquantes ou endommagées.

IT

1. PRECAUZIONI

Non trascinare i mobili durante lo spostamento, ma sollevarli sempre.

Controllare regolarmente tutti i fissaggi per verificare che non vi siano allentamenti e serrare nuovamente se necessario.

Maneggiare o spostare i mobili con cautela, poiché la disattenzione può causare danni o lesioni.

I mobili possono essere pericolosi se non installati correttamente.

Non ci si assume alcuna responsabilità per danni o lesioni causati da un'installazione o un montaggio non corretti.

Conservare queste istruzioni per riferimenti futuri.

2. CURA E MANUTENZIONE

Spolverare regolarmente con un panno pulito, morbido e asciutto.

Non utilizzare prodotti abrasivi o acidi. Non utilizzare solventi per la pulizia.

Solo pulizia professionale.

3. ATTENZIONE

(1) Utilizzare il dispositivo di montaggio a parete in dotazione.

(2) Non permettere mai ai bambini di arrampicarsi o appendersi ai cassetti, alle porte o ai ripiani.

(3) Collocare gli oggetti più pesanti nei cassetti o nei ripiani sottostanti.

(4) Non collocare televisori o altri oggetti pesanti sopra questo prodotto, a meno che non siano specificamente progettati per sostenerli.

(5) Non aprire più di un cassetto alla volta.

Gli accessori vengono forniti con il prodotto; tuttavia, è necessario trovare i dispositivi adeguati al tipo di parete. In caso di dubbi, consultare un professionista qualificato.

Assicurarsi sempre che la parete da forare sia priva di fili nascosti, tubi dell'acqua e del gas.

(6) Questo prodotto contiene piccole parti. Tenere tutte le piccole parti fuori dalla portata dei bambini. Se ingerite o inalate, queste piccole parti possono essere letali.

(7) Conservare i sacchetti di plastica lontano dalla portata dei bambini per evitare pericoli

come il soffocamento.

4. ISTRUZIONI PER L'INSTALLAZIONE

Il montaggio deve essere eseguito solo da un adulto competente.

I bambini devono essere tenuti lontani dal prodotto durante l'assemblaggio, poiché potrebbe esserci il rischio di lesioni.

Non utilizzare il prodotto se alcune parti sono mancanti o danneggiate.

ES

1. PRECAUCIONES

No arrastre al mover los muebles, levántelos siempre.

Compruebe regularmente todos los elementos de fijación para asegurarse de que no están flojos y vuelva a apretarlos si es necesario.

Manipule o mueva los muebles con cuidado, ya que un descuido puede causar daños o lesiones.

Los muebles pueden ser peligrosos si no se instalan correctamente.

No se aceptará ninguna responsabilidad por daños o lesiones causados por una instalación o montaje inadecuados.

Conserve estas instrucciones para futuras consultas.

2. CUIDADO Y MANTENIMIENTO

Limpie regularmente el polvo con un paño limpio, suave y seco.

No utilice productos abrasivos ni ácidos. No utilice disolventes de limpieza.

Limpieza profesional únicamente.

3. ADVERTENCIA

(1) Utilice el dispositivo de fijación mural suministrado.

(2) Nunca permita que los niños trepen o se cuelguen de los cajones, puertas o estantes.

(3) Coloque los objetos más pesados en los cajones o estantes inferiores.

(4) No coloque televisores u otros objetos pesados encima de este producto a menos que estén específicamente diseñados para sostenerlos.

(5) No abra más de un cajón a la vez.

El equipo accesorio viene con su producto; sin embargo, usted necesitará encontrar los accesorios apropiados para su tipo de pared. En caso de duda, consulte a un profesional cualificado.

Asegúrese siempre de que la pared que va a perforar está libre de cables ocultos, tuberías de agua y tuberías de gas.

(6) Este producto contiene piezas pequeñas. Mantenga todas las piezas pequeñas fuera del alcance de los niños. Si se tragan o inhalan, estas piezas pequeñas pueden ser mortales.

(7) Guarde las bolsas de plástico fuera del alcance de los niños para evitar riesgos como asfixia.

4. INSTRUCCIONES DE MONTAJE

El montaje sólo debe ser realizado por un adulto competente.

Los niños deben mantenerse alejados del producto durante el montaje, ya que puede haber riesgo de lesiones.

No utilice este artículo si falta alguna pieza o está dañado.

NOTICE

EN: IMPORTANT, RETAIN FOR FUTURE REFERENCE: READ CAREFULLY
DE: WICHTIG, FÜR SPÄTERE NACHSCHLAGE AUFBEWAHREN: SORGFÄLTIG LESEN
FR: IMPORTANTE, GUARDAR PARA REFERENCIA FUTURA: LEER ATENTAMENTE
IT: IMPORTANTE, CONSERVARE PER RIFERIMENTI FUTURI: LEGGERE ATTENTAMENTE
ES: IMPORTANTE, À CONSERVER POUR RÉFÉRENCE FUTURE : LIRE ATTENTIVEMENT

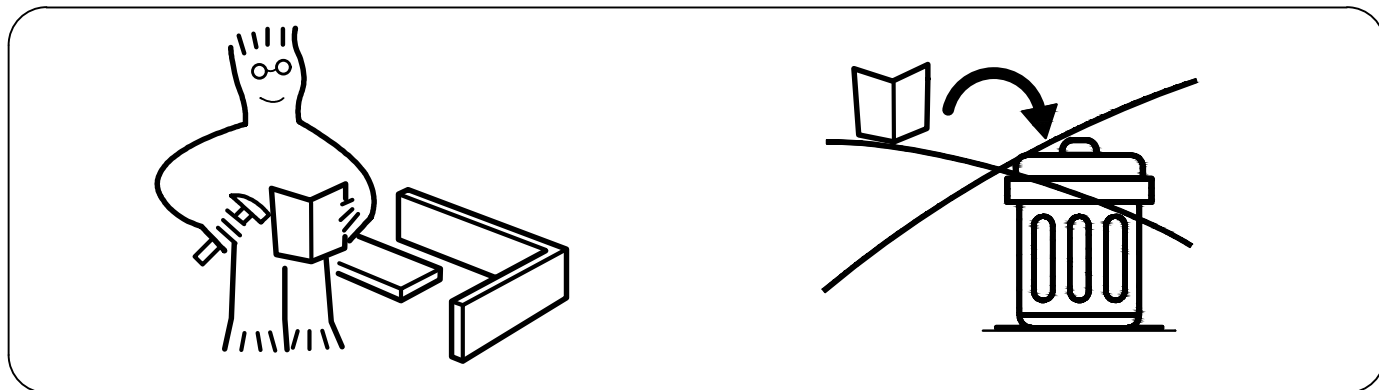

EN: Assemble on a flat, clean and soft surface.
DE: Auf einer flachen, sauberen und weichen Oberfläche zusammenbauen.
FR: Assembler sur une surface plate, propre et douce.
IT: Assemblare su una superficie piatta, pulita e morbida.
ES: Ensamblar sobre una superficie plana, limpia y suave.

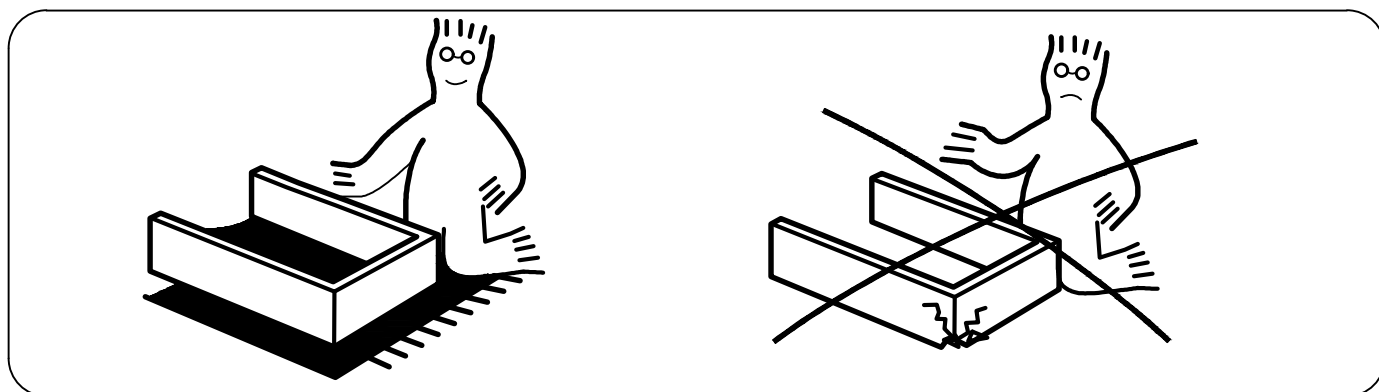

EN: Professional installation is highly recommended.
DE: Eine professionelle Installation wird dringend empfohlen.
FR: Une installation professionnelle est fortement recommandée.
IT: Si raccomanda vivamente l'installazione professionale.
ES: Se recomienda altamente la instalación profesional.



EN: Periodically Check That All Components Are Tightly Secured.
DE: Überprüfen Sie Regelmäßig, Dass Alle Komponenten Fest Gesichert Sind.
FR: Vérifiez Périodiquement Que Tous Les Composants Sont Bien Fixés.
IT: Controllare Periodicamente Che Tutti I Componenti Siano Ben Fissati.
ES: Verifique Periódicamente Que Todos Los Componentes Estén Bien Asegurados.

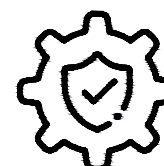

EN: It is recommended that multiple people assemble this product.

DE: Es wird empfohlen, dass mehrere Personen dieses Produkt zusammenbauen.

FR: Il est recommandé que plusieurs personnes assemblent ce produit.

IT: Si raccomanda che più persone assemblino questo prodotto.

ES: Se recomienda que varias personas ensamben este producto.

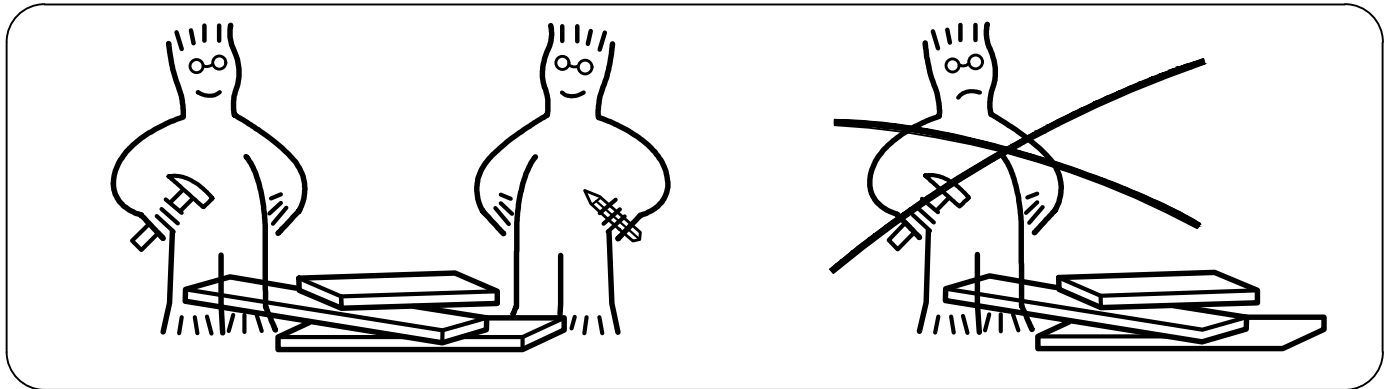

EN: USING CAM LOCK AND CAM BOLT
 DE: VERWENDUNG VON NOCKENSCHLOSS UND CAM BOLT
 FR: UTILISATION DE SERRURE À CAME ET CAM BOLT
 IT: USO DISERRATURA A LEVA E CAM BOLT
 ES: USANDO EL CIERRE DE LEVA Y CAM BOLT

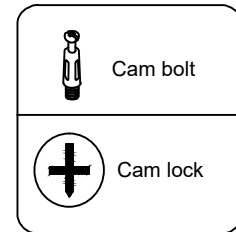

EN: Tighten cam bolt until the shoulder is flush with the panel. Do not overtighten or undertighten.
 DE: Ziehen Sie den cam bolt an, bis die Schulter bündig mit der Platte ist. Nicht zu fest oder zu locker anziehen.
 FR: Serrez le cam bolt jusqu'à ce que l'épaulement soit affleurant avec le panneau. Ne serrez pas trop ou trop peu.
 IT: Stringere il cam bolt fino a quando la spalla è a filo con il pannello. Non stringere troppo o troppo poco.
 ES: Apriete el cam bolt hasta que el hombro esté al ras con el panel. No apriete demasiado ni demasiado poco.

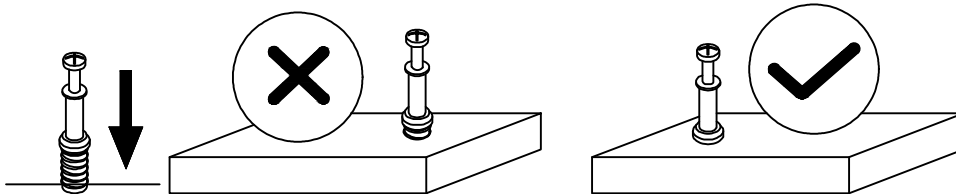

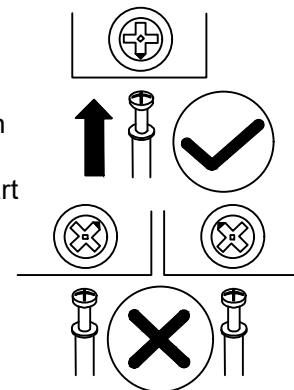

EN: When fitting the cam lock, ensure the starting position is correct before inserting the connecting cam bolt.
 DE: Stellen Sie beim Einbau des Nockenschloss sicher, dass die Startposition korrekt ist, bevor Sie den verbindenden cam bolt einsetzen.
 FR: Lors de la pose du serrure à came, assurez-vous que la position de départ est correcte avant d'insérer le cam bolt de connexion.
 IT: Quando si monta il serratura a leva, assicurarsi che la posizione di partenza sia corretta prima di inserire il cam bolt di collegamento.
 ES: Al instalar el cierre de leva, asegúrese de que la posición inicial sea correcta antes de insertar el cam bolt de conexión.

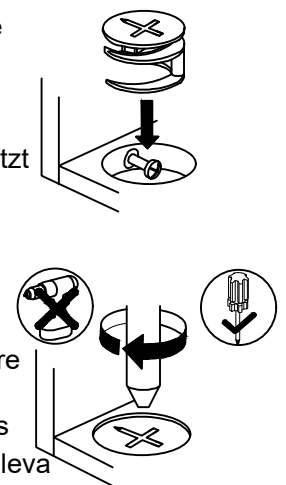

EN: The cam bolt head should be in the center of the cam lock when the two panels are joined. The cam bolt should be inserted before the cam lock. Turn the cam lock clockwise to tighten.
 DE: Der Cam Bolt-Kopf sollte sich in der Mitte des Nockenschloss befinden, wenn die beiden Platten verbunden sind. Der cam bolt sollte vor dem Nockenschloss eingesetzt werden. Drehen Sie den Nockenschloss im Uhrzeigersinn, um ihn zu befestigen.
 FR: La tête du cam bolt doit être au centre du serrure à came lorsque les deux panneaux sont assemblés. Le cam bolt doit être inséré avant le serrure à came. Tournez le serrure à came dans le sens des aiguilles d'une montre pour le serrer.
 IT: La testa del cam bolt dovrebbe essere al centro della serratura a leva quando i due pannelli sono uniti. Il cam bolt deve essere inserito prima della serratura a leva. Ruotare il serratura a leva in senso orario per stringere.
 ES: La cabeza del cam bolt debe estar en el centro del cam lock cuando los dos paneles estén unidos. El cam bolt debe insertarse antes del cierre de leva. Gire el cierre de leva en sentido horario para apretar.

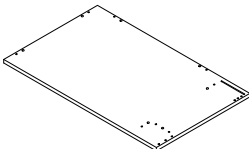
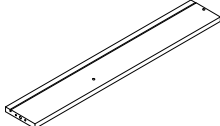
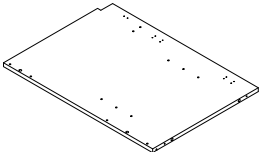
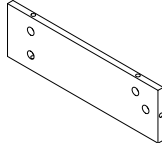
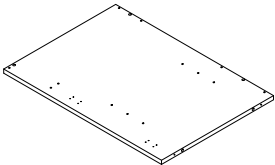
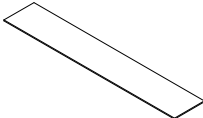
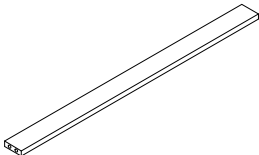
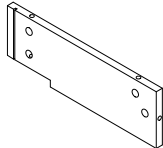
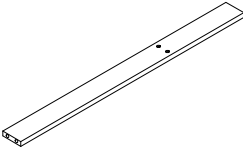
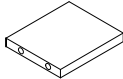
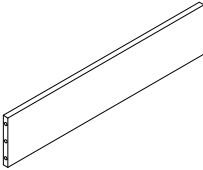
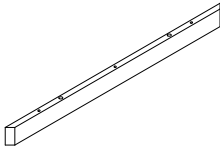
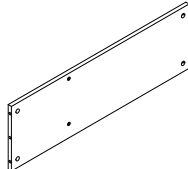
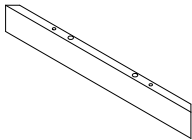
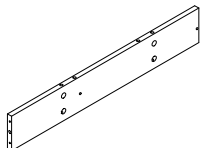

PART LIST

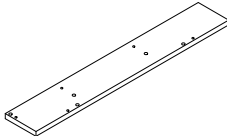
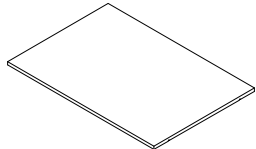



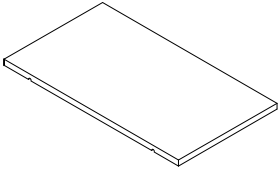
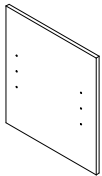
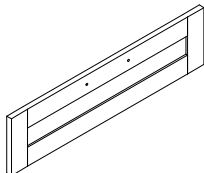

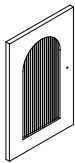
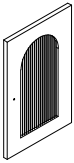
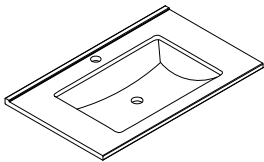

Item no. Nr. N d'aricle Articolo No. Artículo No.	Reference Image Referenzbild. Image de référence Imagine di riferimento Imagen de referencia	Qty. Menge Qté. Qtà Cant	Item no. Nr. N d'aricle Articolo No. Artículo No.	Reference Image Referenzbild. Image de référence Imagine di riferimento Imagen de referencia	Qty. Menge Qté. Qtà Cant
1		X1	10		X1
2		X1	11		X1
3		X1	12		X1
4		X1	13		X1
5		X1	14		X2
6		X1	15		X2
7		X1	16		X2
8		X1	17		X4
9		X1	18		X1

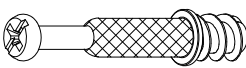
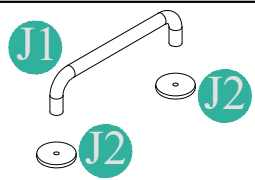
PART LIST

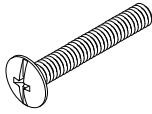
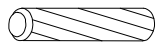
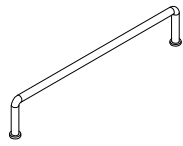

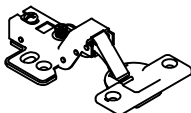
Item no. Nr. N d'aricle Articolo No. Artículo No.	Reference Image Referenzbild. Image de référence Imagine di riferimento Imagen de referencia	Qty. Menge Qté. Qtà Cant
19		X1
20		X1
21		X1

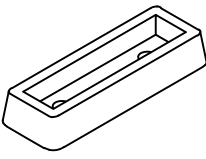
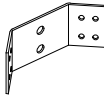
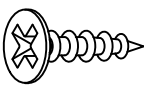

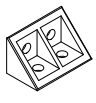
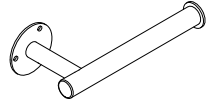
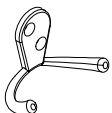
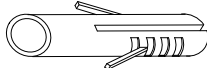
Item no. Nr. N d'aricle Articolo No. Artículo No.	Reference Image Referenzbild. Image de référence Imagine di riferimento Imagen de referencia	
22		X1
23		X2
24		X1

HARDWARE LIST

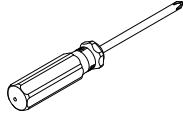
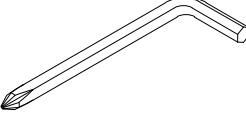
Item no. Nr. N d'aricle Articolo No. Artículo No.	Reference Image Referenzbild. Image de référence Imagine di riferimento Imagen de referencia	Qty. Menge Qté. Qtà Cant	Item no. Nr. N d'aricle Articolo No. Artículo No.	Reference Image Referenzbild. Image de référence Imagine di riferimento Imagen de referencia	Qty. Menge Qté. Qtà Cant
A	 M6x34MM	X30+2	J		X1 Set
B	 Ø15x9MM	X30+2	K	 Ø4x19MM	X5
C	 Ø8x30MM	X34+2	L		X1
D	 Ø5x45MM	X18+1	M		X3
E		X6	N		X8
F		X1	O		X4
G	White color  Ø3.5x12MM	X55+2	P	 Ø6x12MM	X8
H		X2	Q		X1
I		X2	R		X4

HARDWARE LIST

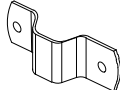
Item no. Nr. N d'aricle Articolo No. Artículo No.	Reference Image Referenzbild. Image de référence Imaginé di riferimento Imágen de referencia	Qty. Menge Qté. Qtà Cant
S	 Ø4x38MM	X14
U		X1
V		X1
T		X2

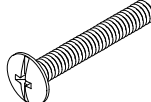
Item no. Nr. N d'aricle Articolo No. Artículo No.	Reference Image Referenzbild. Image de référence Imaginé di riferimento Imágen de referencia	Qty. Menge Qté. Qtà Cant
X		X4
Y	Black color  Ø3.5x12MM	X34+2
Z		X4
W	 5/32x19MM	X2

EXPLODED VIEW

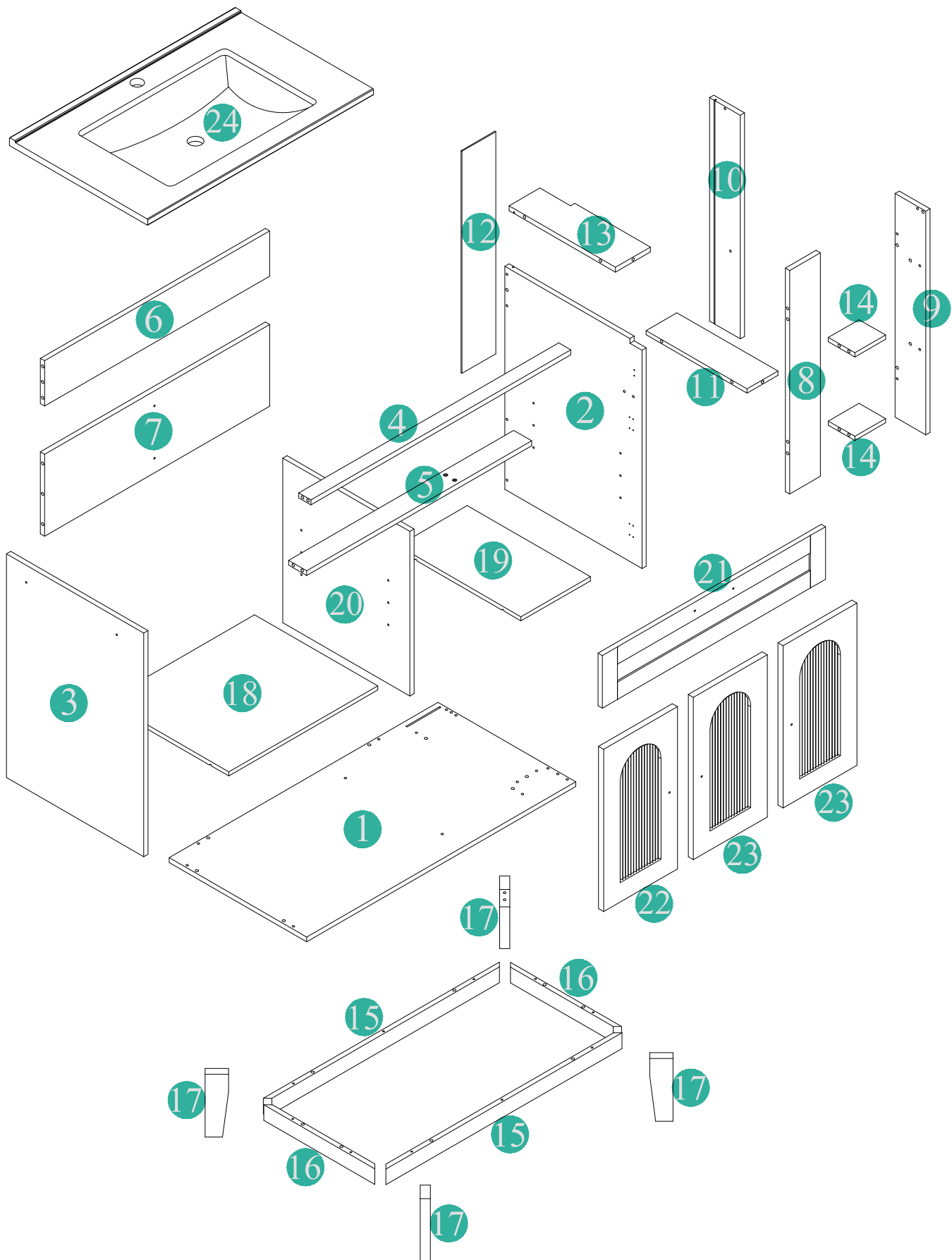



EN: Attention
DE: Beachten
FR: Précautions
IT: Attenzione
ES: Atención

EN: Please don't tighten the screws completely and go back later for a final tightening of all the screws after pieces are aligned with each other.

DE: Ziehen Sie die Schrauben nicht ganz fest, sondern erst, wenn die Teile zueinander ausgerichtet sind, und ziehen Sie schließlich alle Schrauben fest.

FR: Ne serrez pas les vis complètement, revenez lorsque les pièces sont alignées les unes avec les autres et serrez finalement toutes les vis.

IT: Non serrare completamente le viti, tornare indietro quando le parti sono allineate tra loro e serrare infine tutte le viti.

ES: No apriete los tornillos completamente, vuelva cuando las piezas estén alineadas entre sí y apriete finalmente todos los tornillos.

ASSEMBLY

1

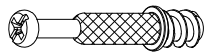

A x2



B x2

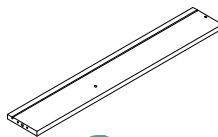

10 x1

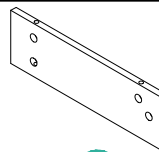

11 x1

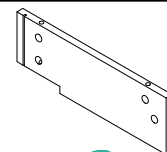

13 x1

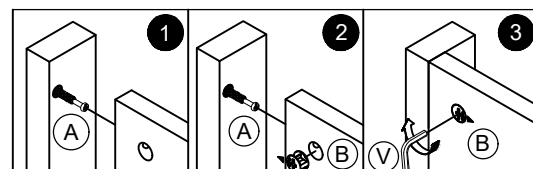
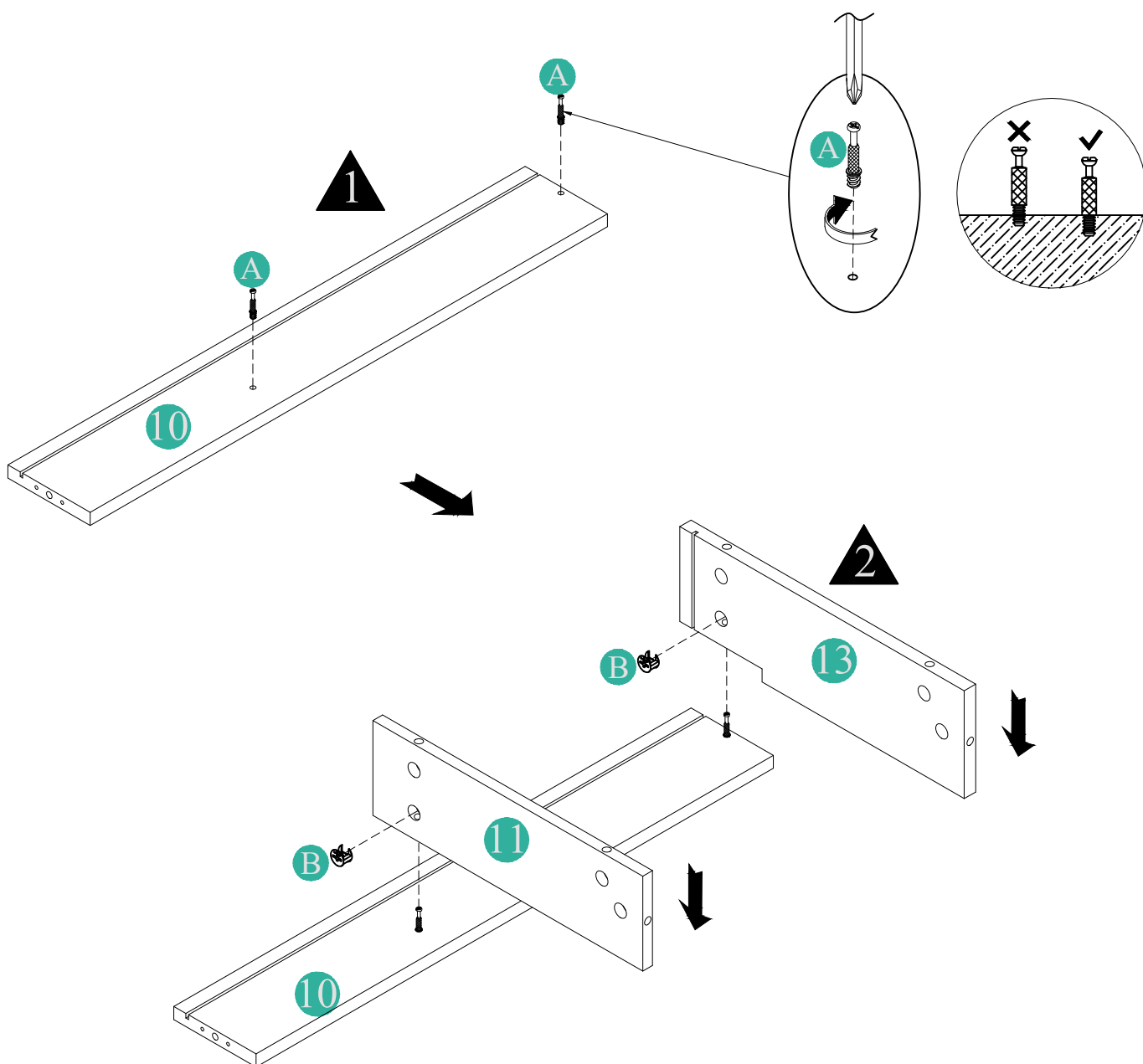

ASSEMBLY

2

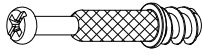

A x7

Ø8x30MM

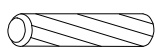

C x2



B x2

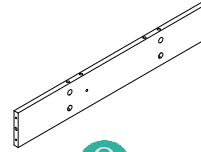

8 x1

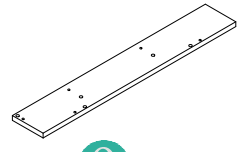

9 x1

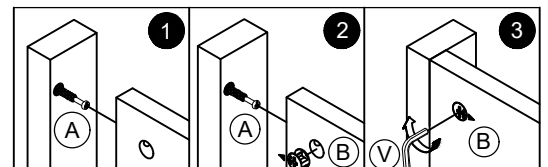
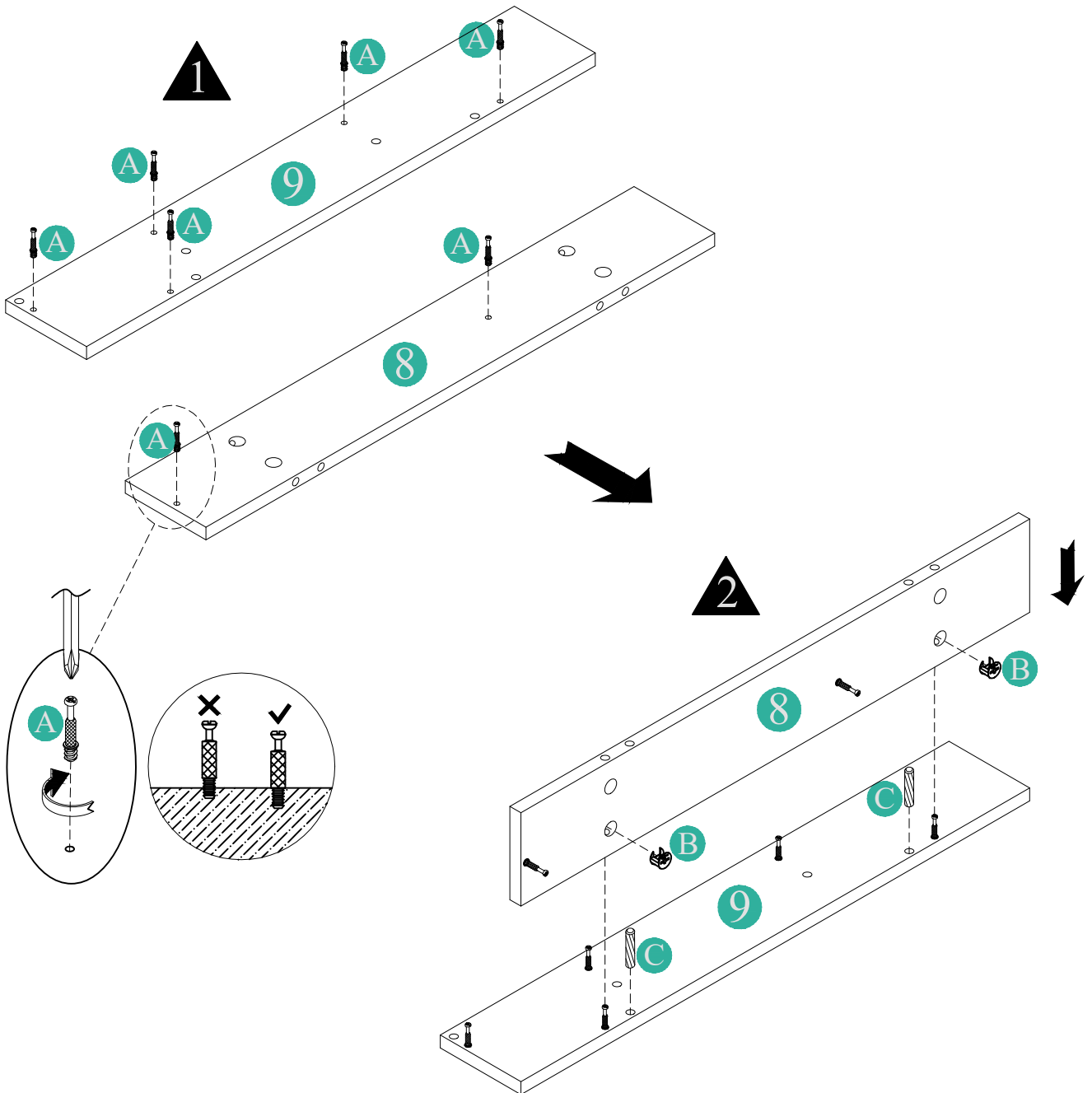

ASSEMBLY

3



B x2

Ø8x30MM

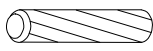

C x2

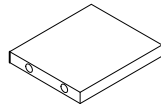

14 x2

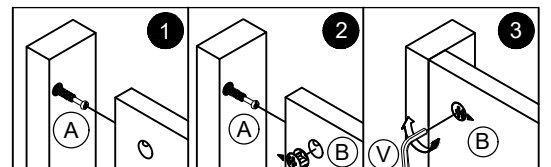
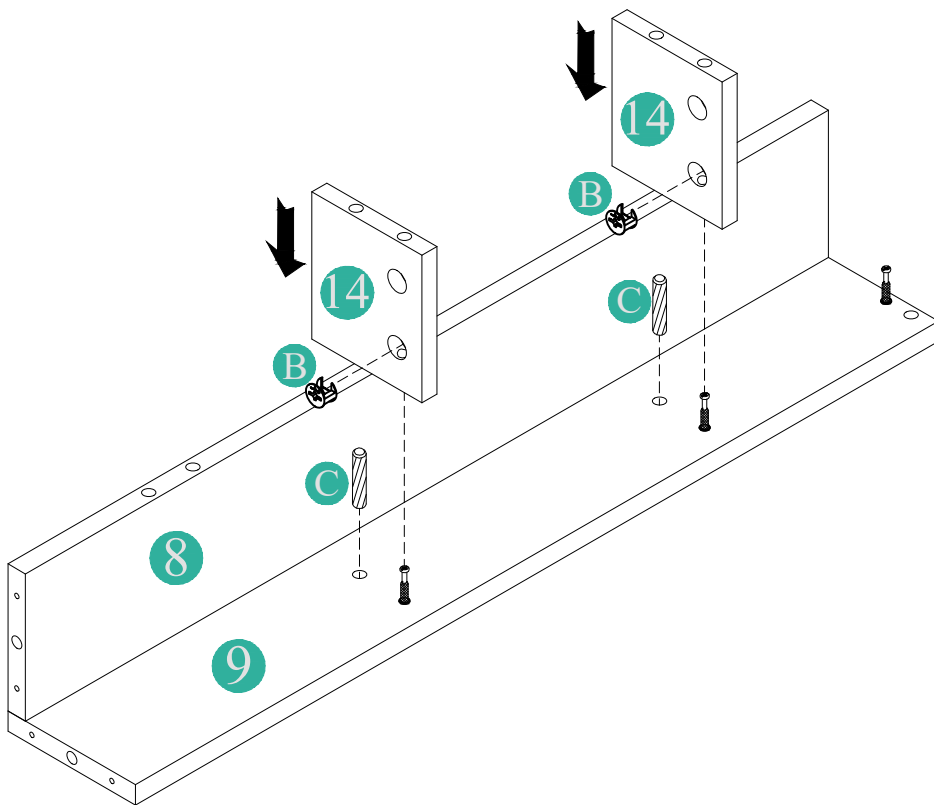

ASSEMBLY

4



B x2

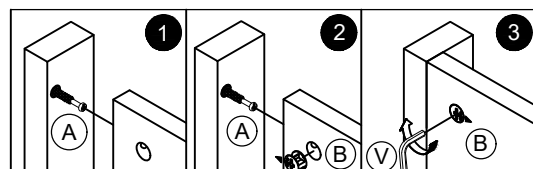
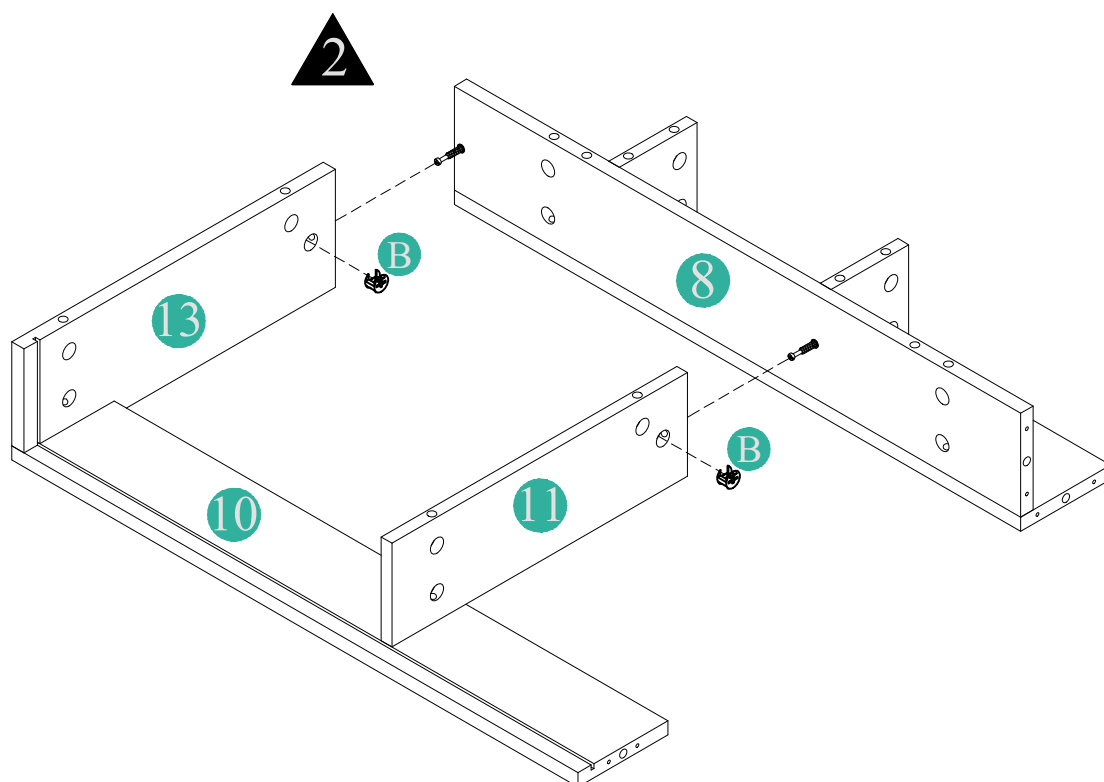

ASSEMBLY

5

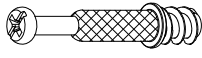

A x14

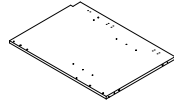

2 x1

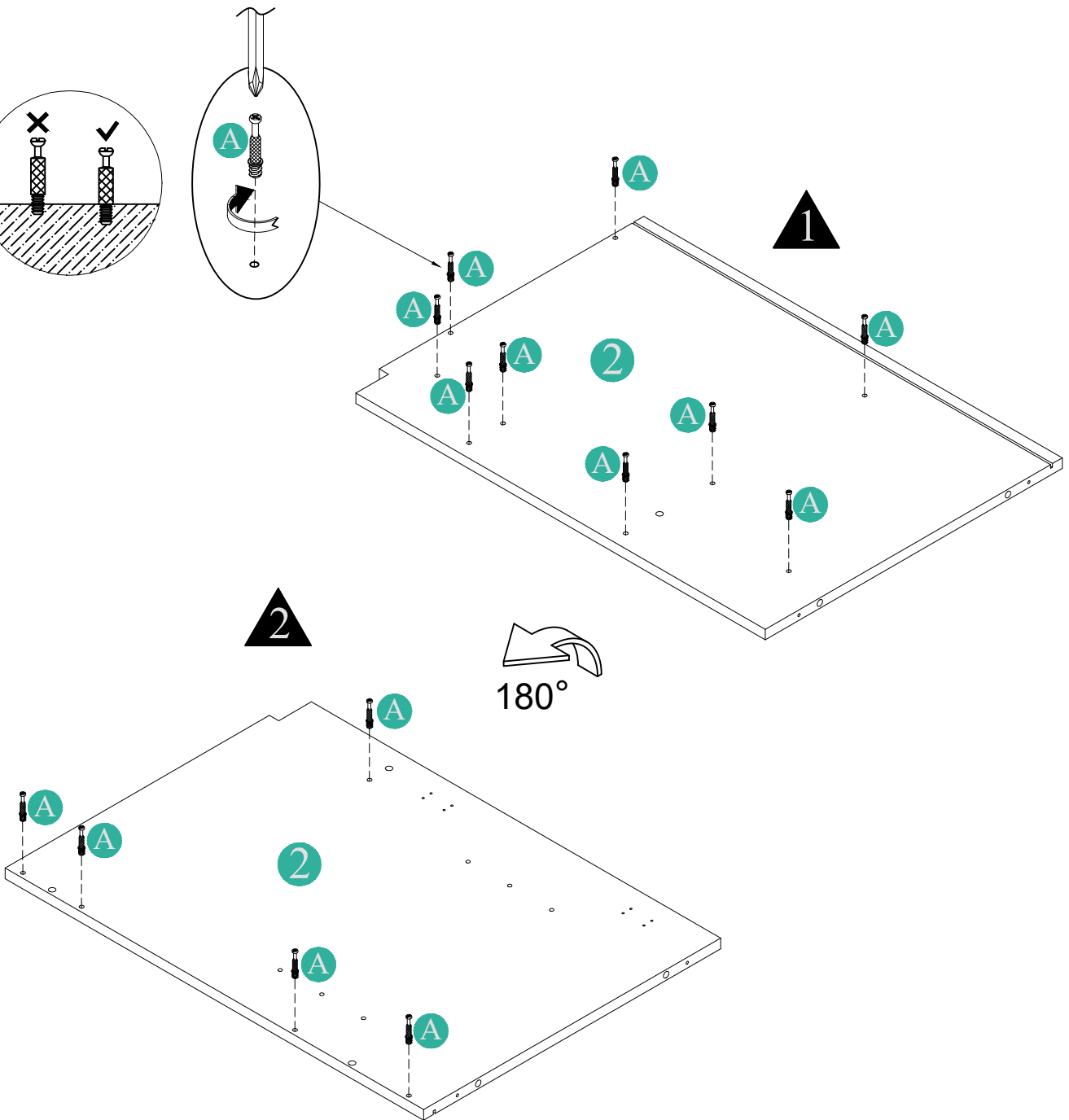
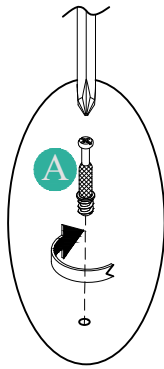
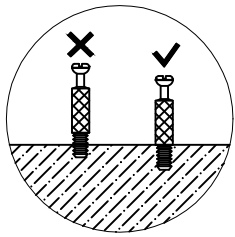

ASSEMBLY

6



B x8

Ø8x30MM

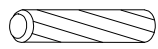

C x4

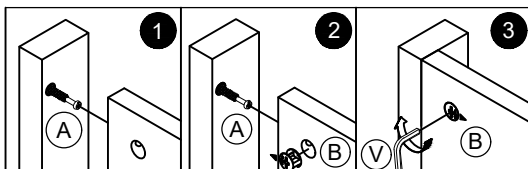
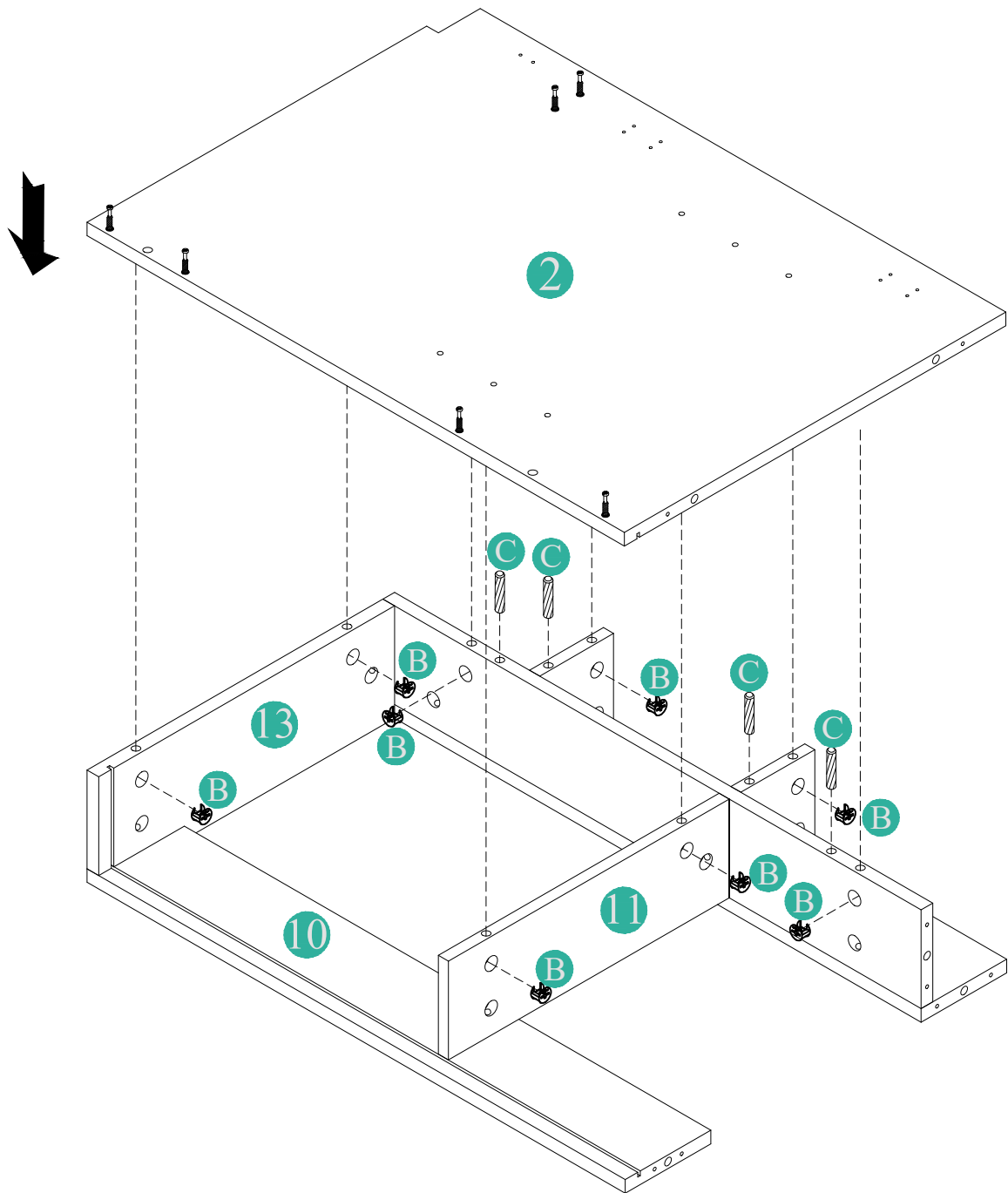

ASSEMBLY

7



B x3

Ø8x30MM



C x2

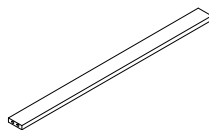

4 x1

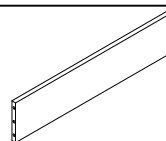

6 x1

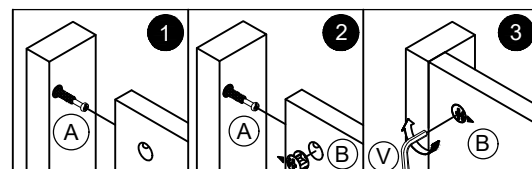
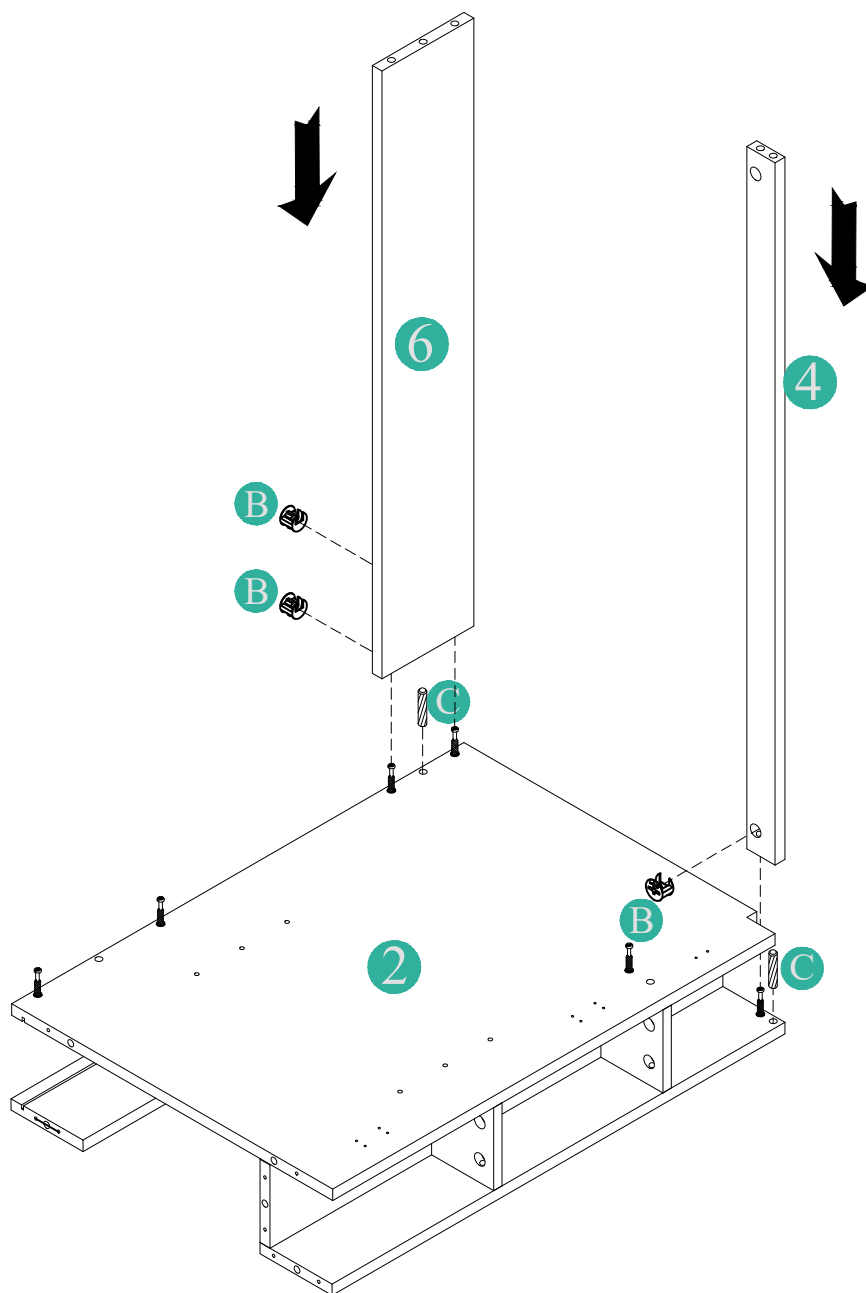

ASSEMBLY

8

Ø8x30MM

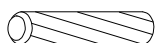

C x1

Ø5x45MM

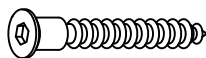

D x2

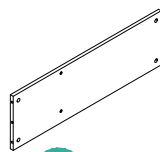

7 x1

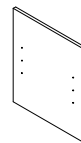

20 x1

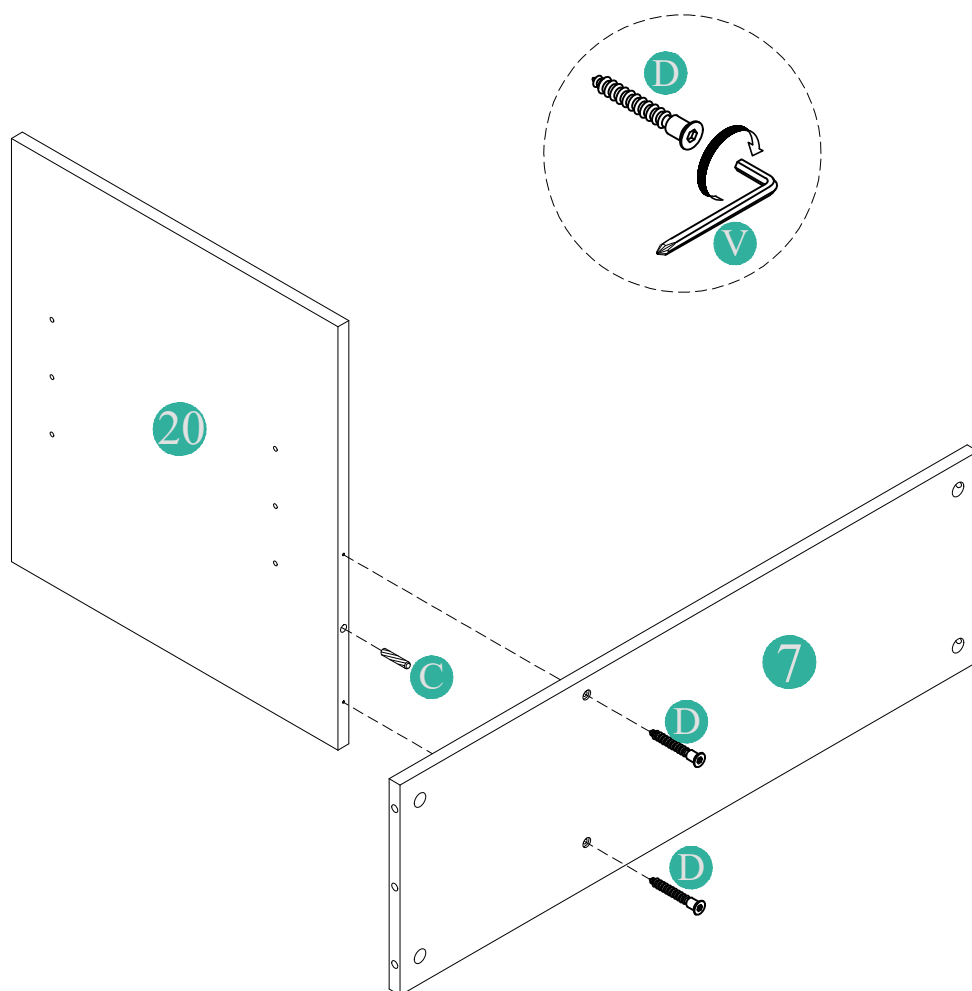

ASSEMBLY

9

Ø5x45MM



D x2

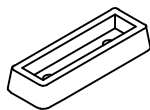

F x1

Ø3.5x12MM



Black color

Y x2

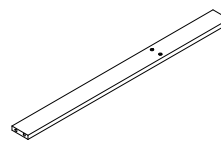

5 x1

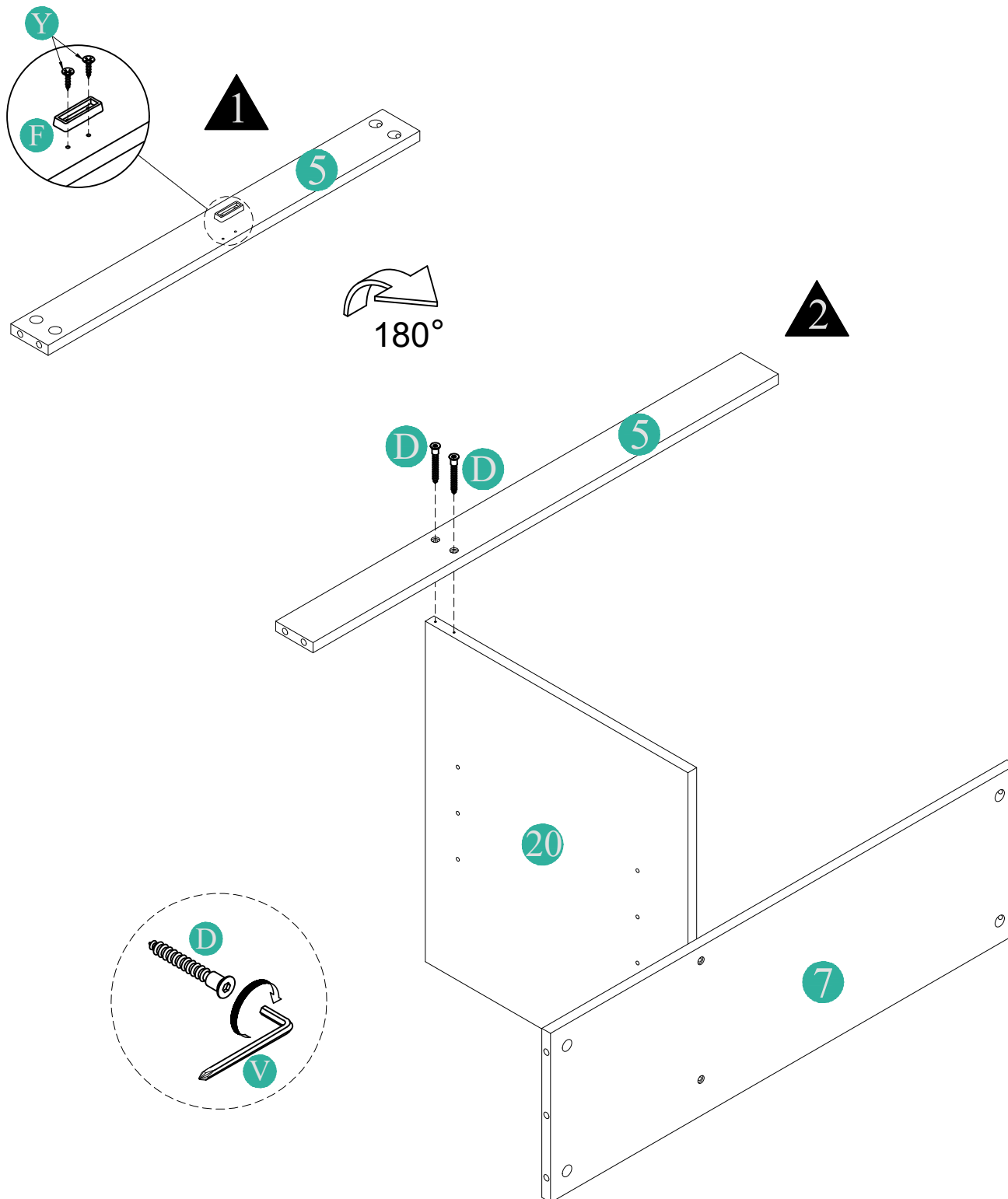

ASSEMBLY

10



B x4

Ø8x30MM



C x1

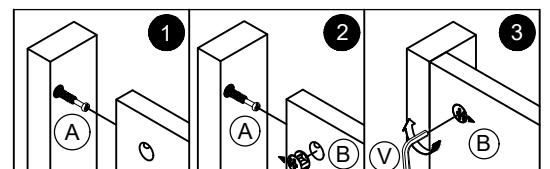
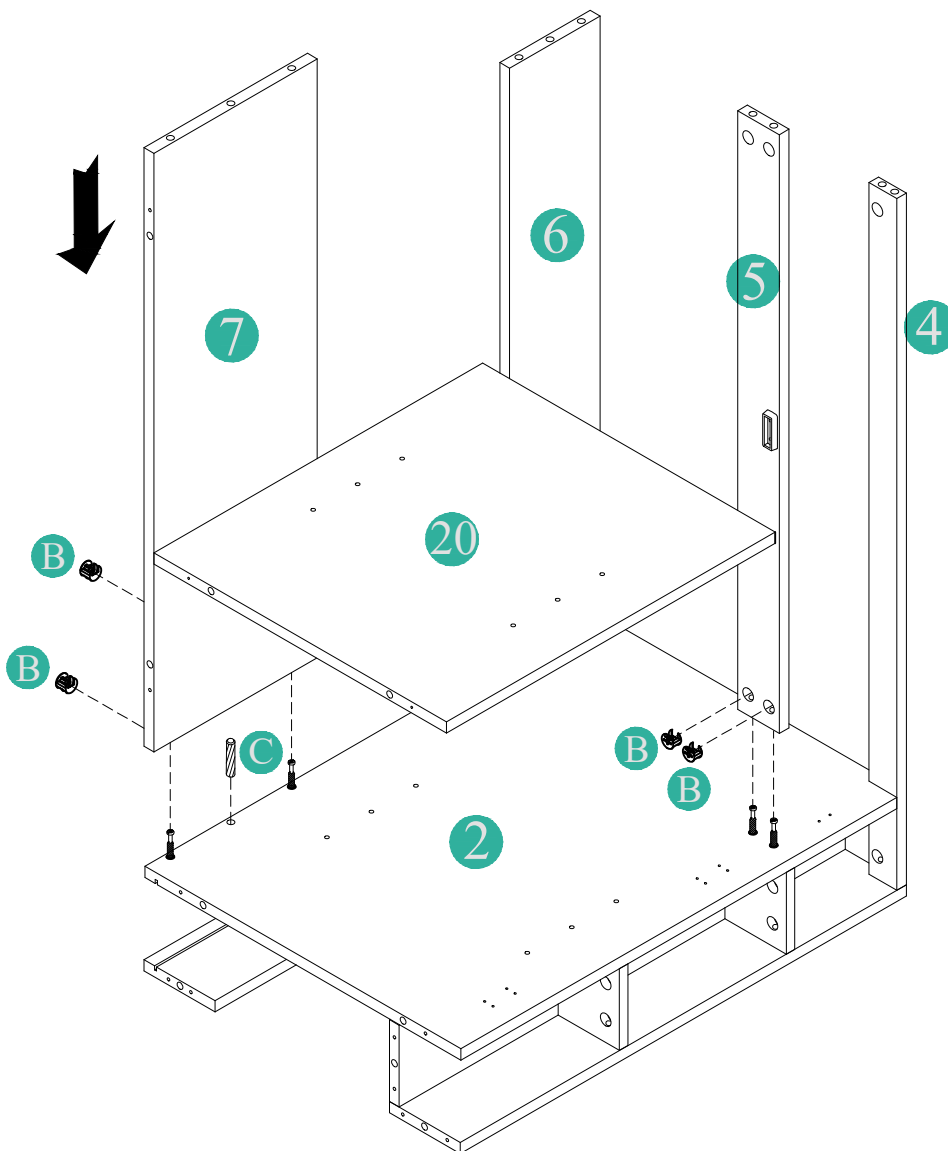

ASSEMBLY

11

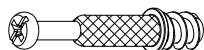

A x7

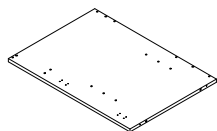

3 x1

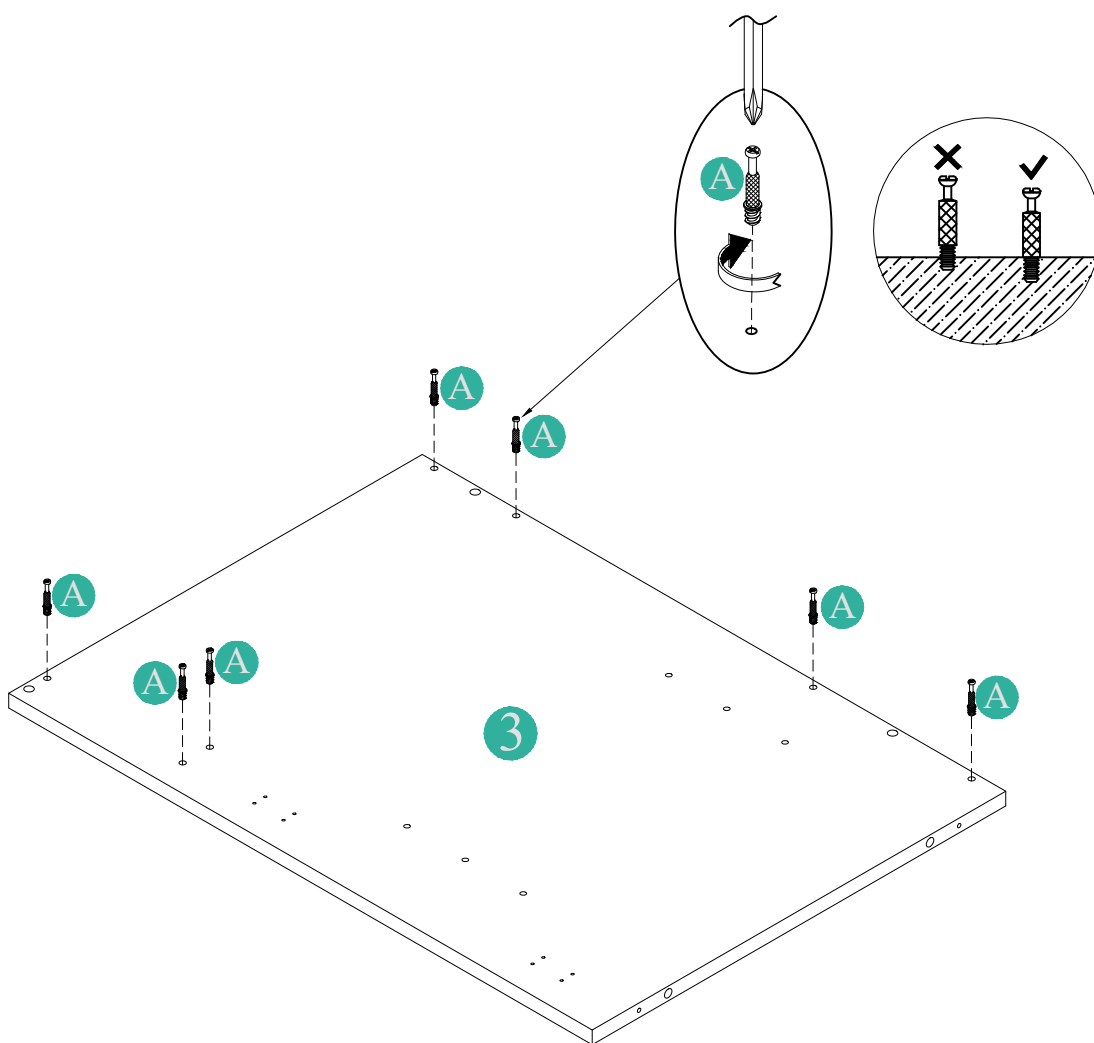

ASSEMBLY

12



B x7

Ø8x30MM

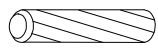

C x3

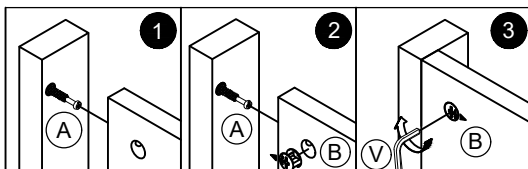
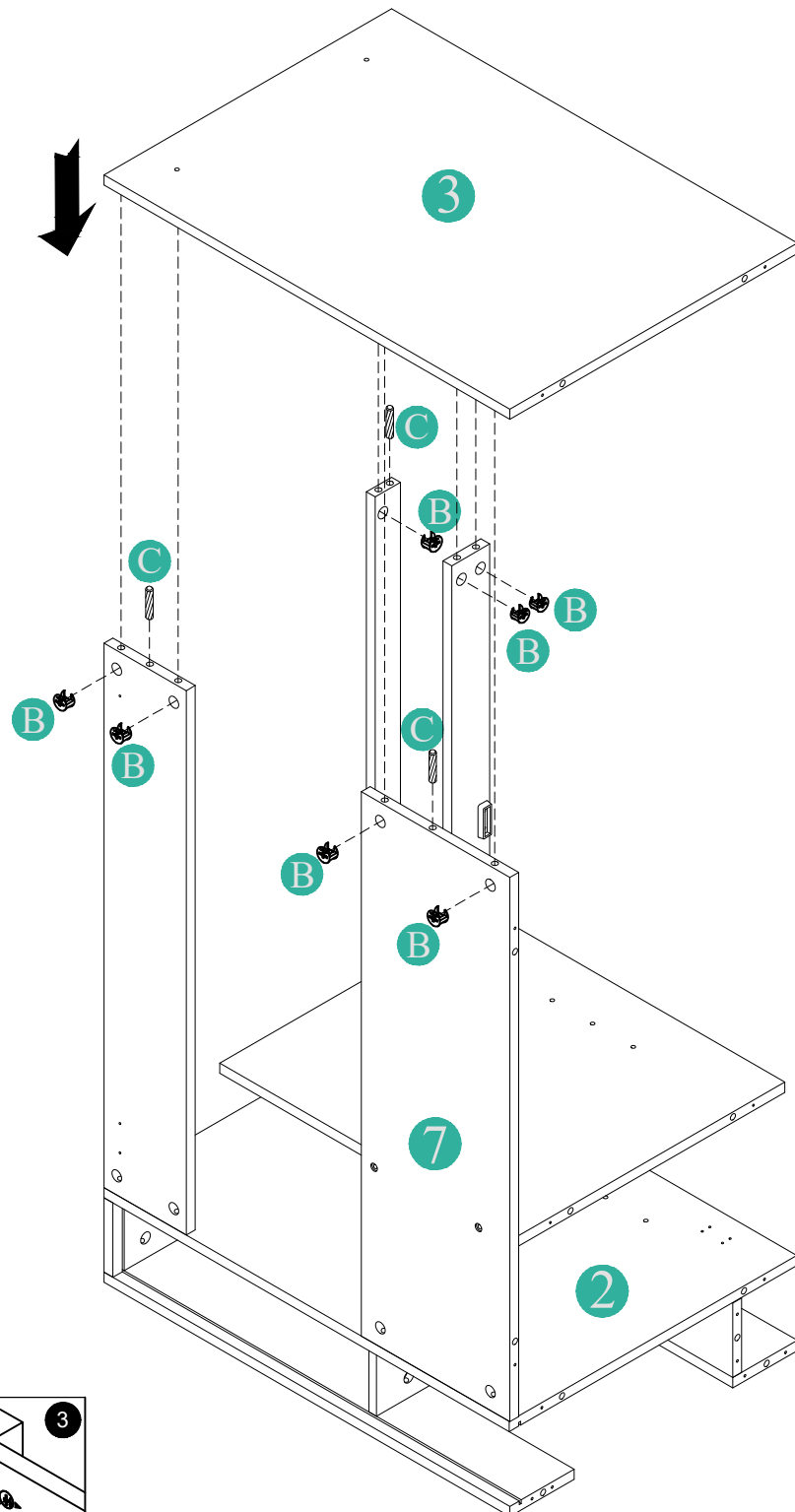

13

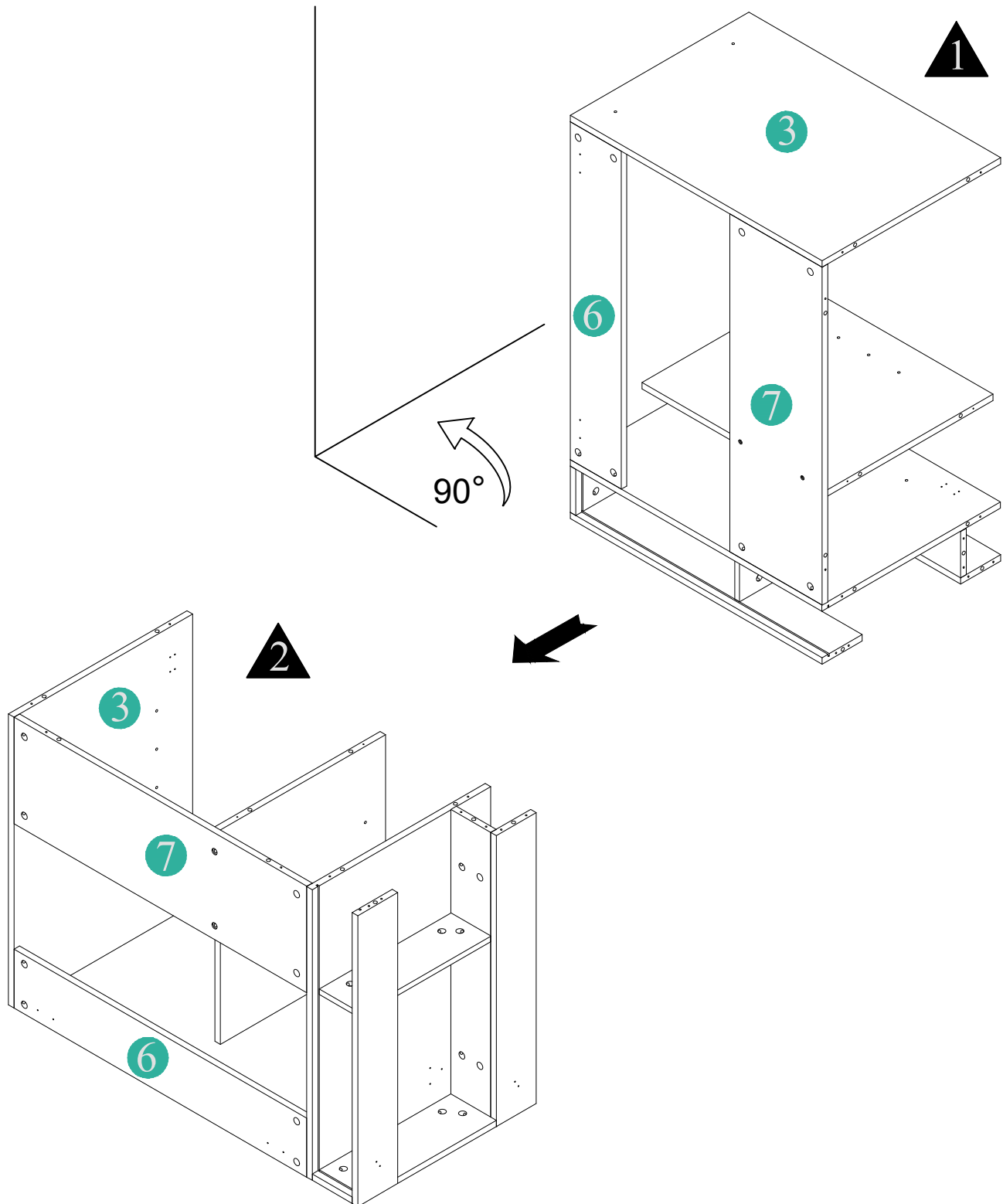

ASSEMBLY

14

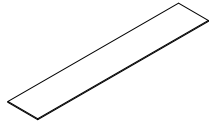

12 x1

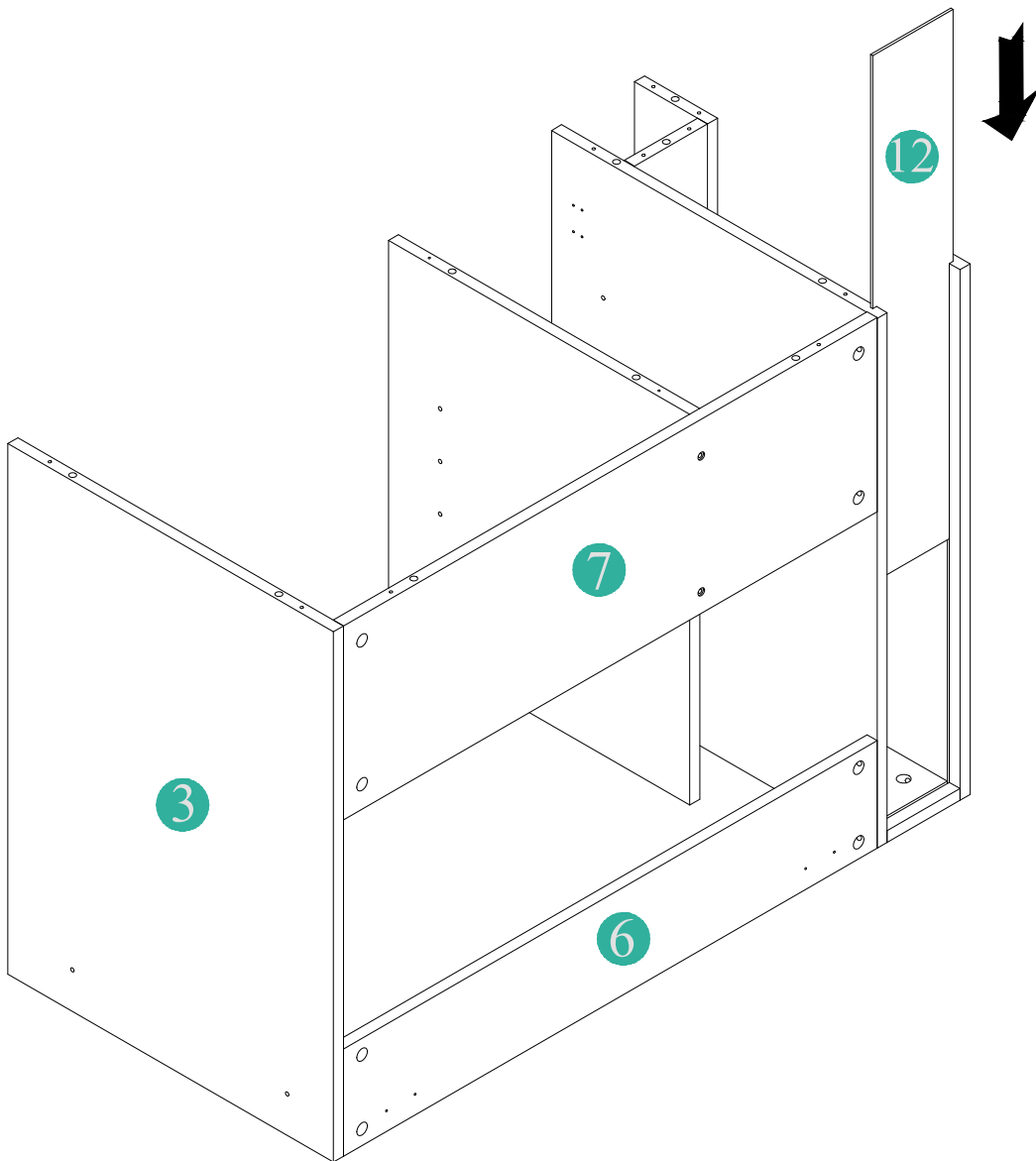

ASSEMBLY

15

Ø8x30MM



C x11

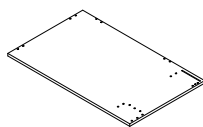

1 x1

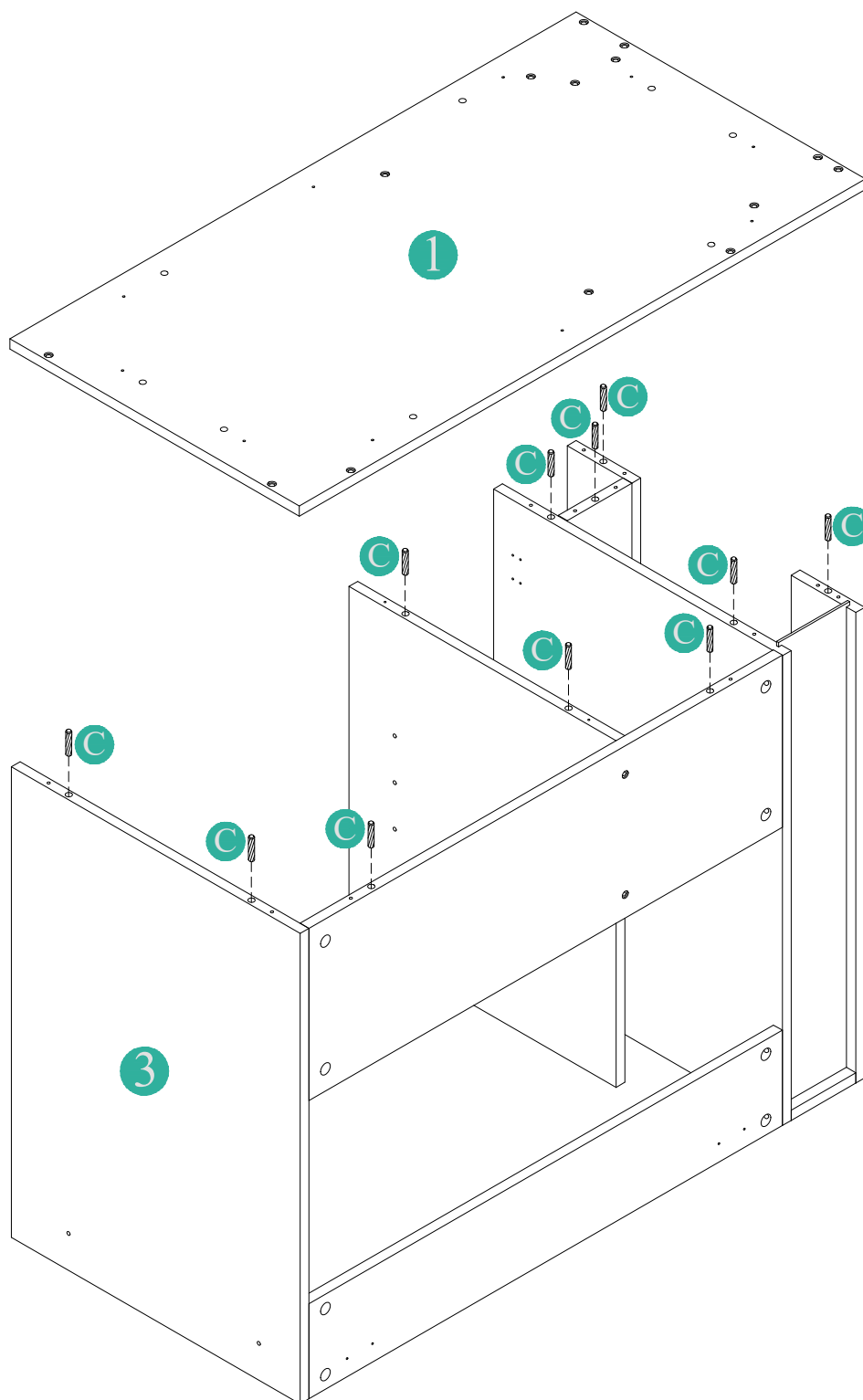

ASSEMBLY

16

Ø5x45MM



D x14

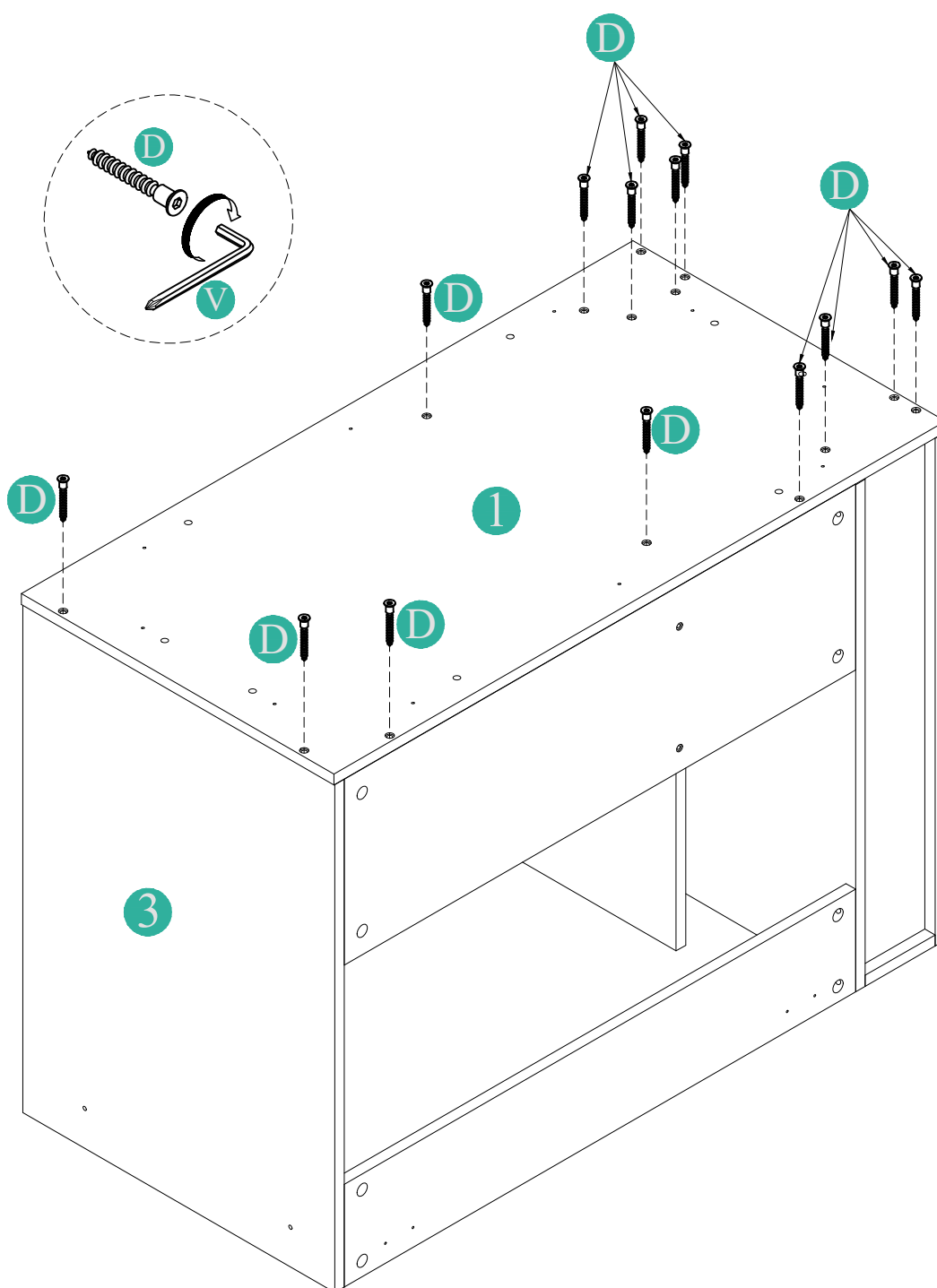

ASSEMBLY

17
x2

Ø3.5x12MM



Black color

Y x16

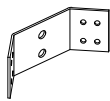

O x4

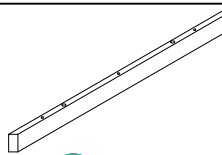

15 x2

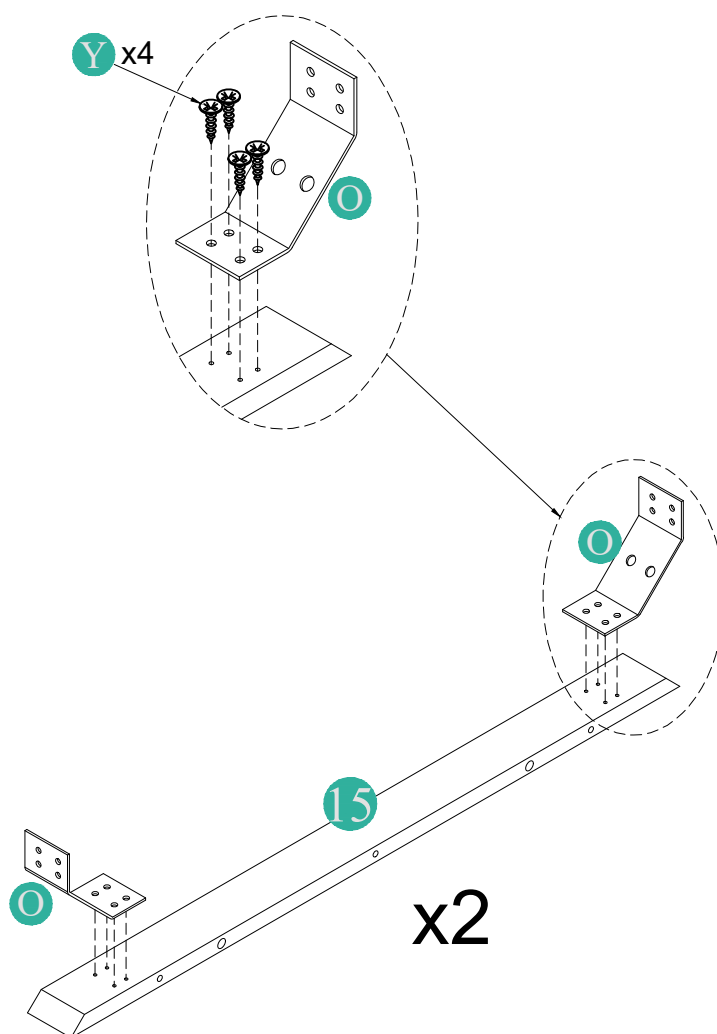

ASSEMBLY

18

Ø3.5x12MM



Black color

Y x16

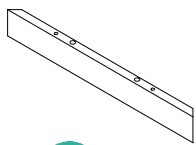

16 x2

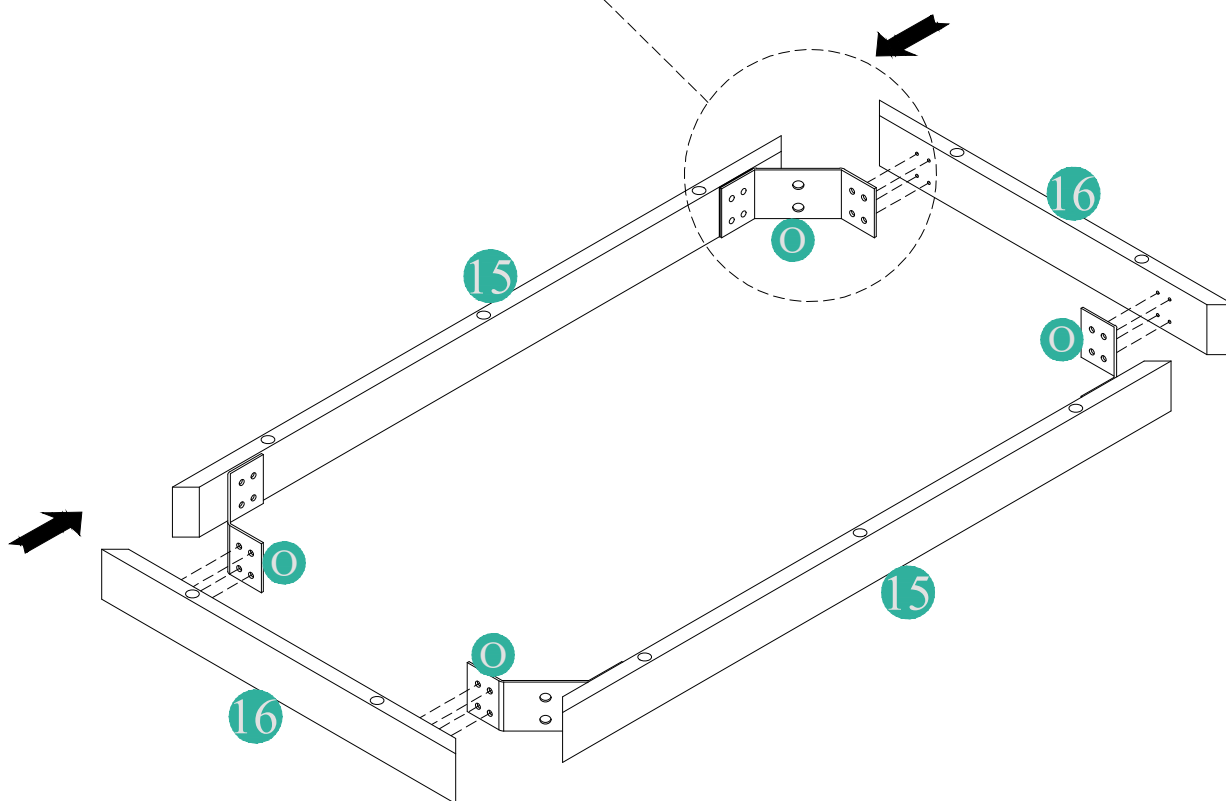
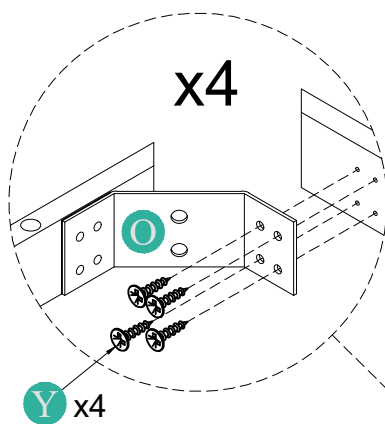

ASSEMBLY

19

Ø8x30MM



C x8

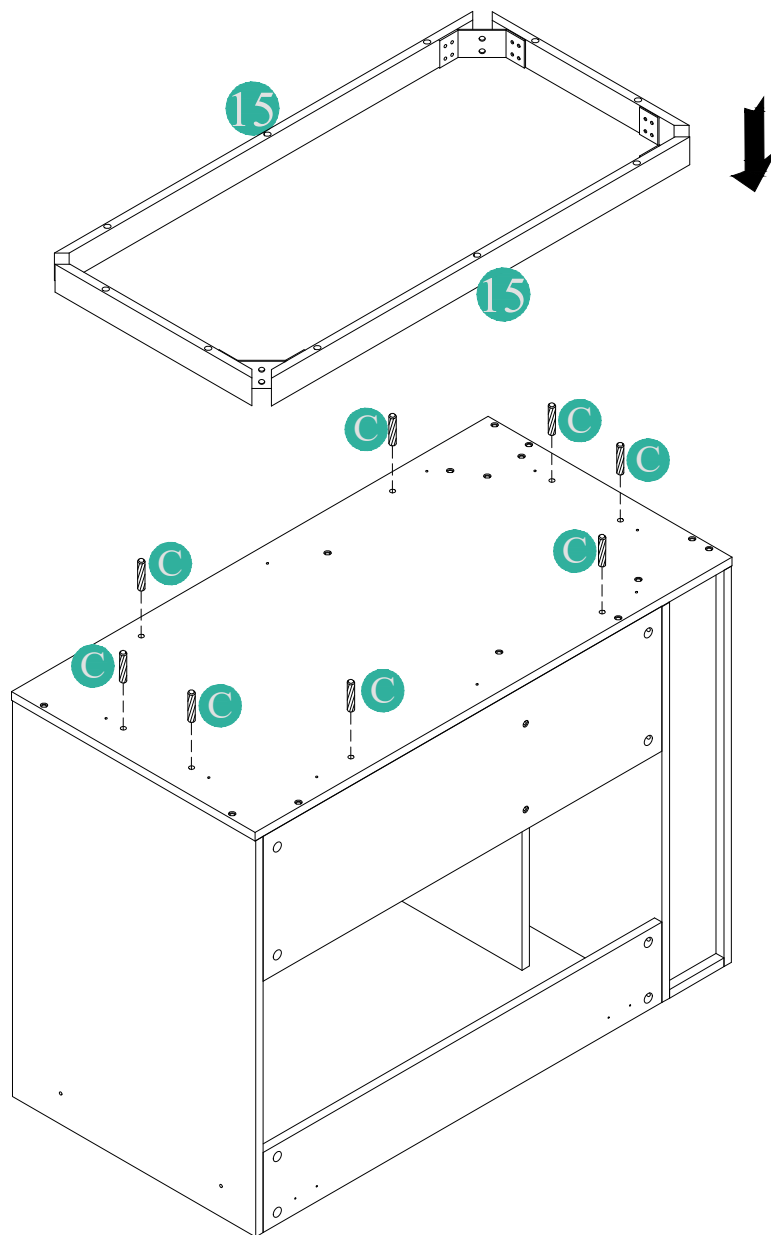

ASSEMBLY

20

Ø4x38MM

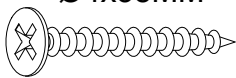

S x10

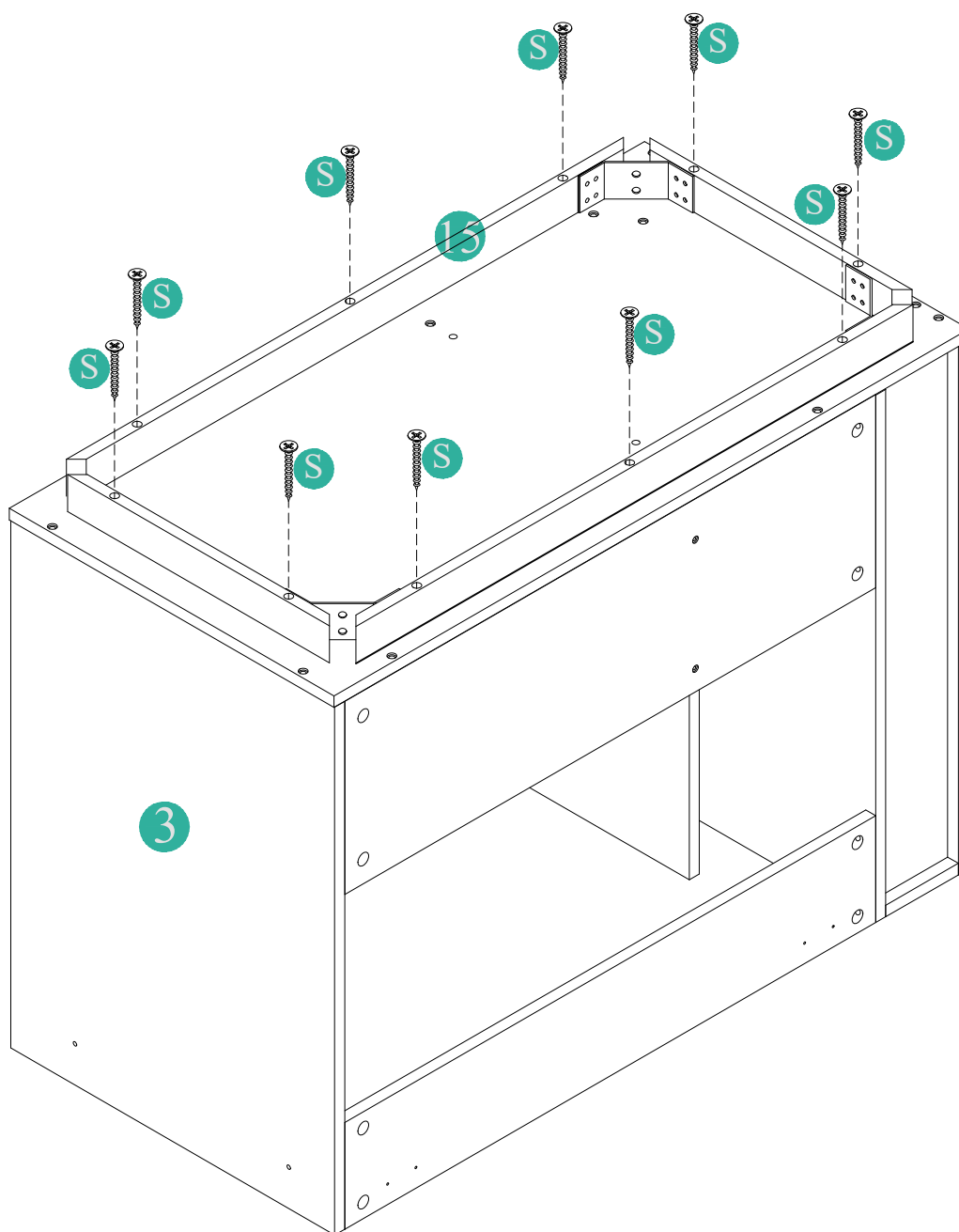

ASSEMBLY

21

Ø6x12MM



P x8



Z x4



14 x4

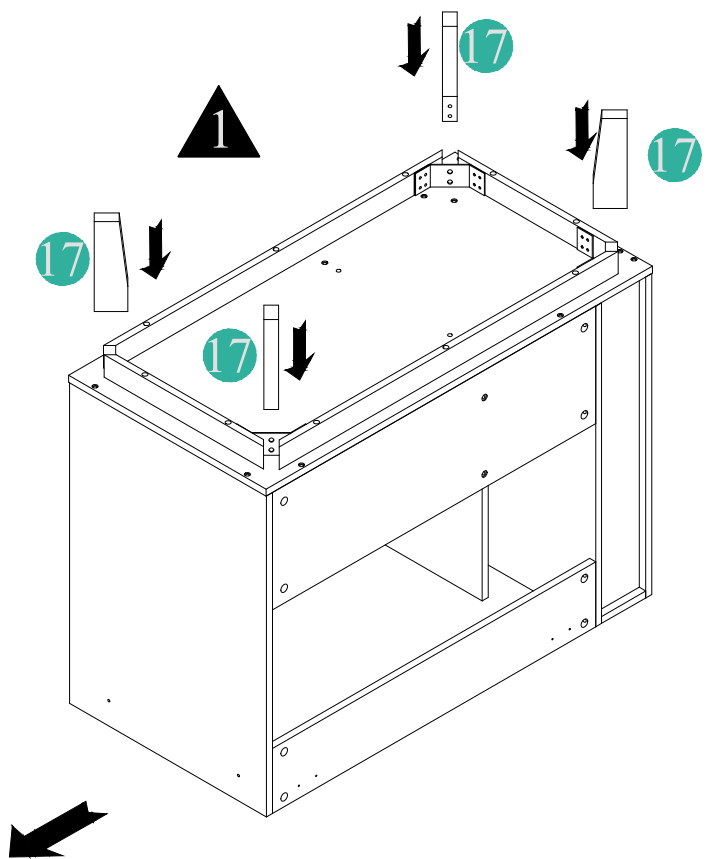
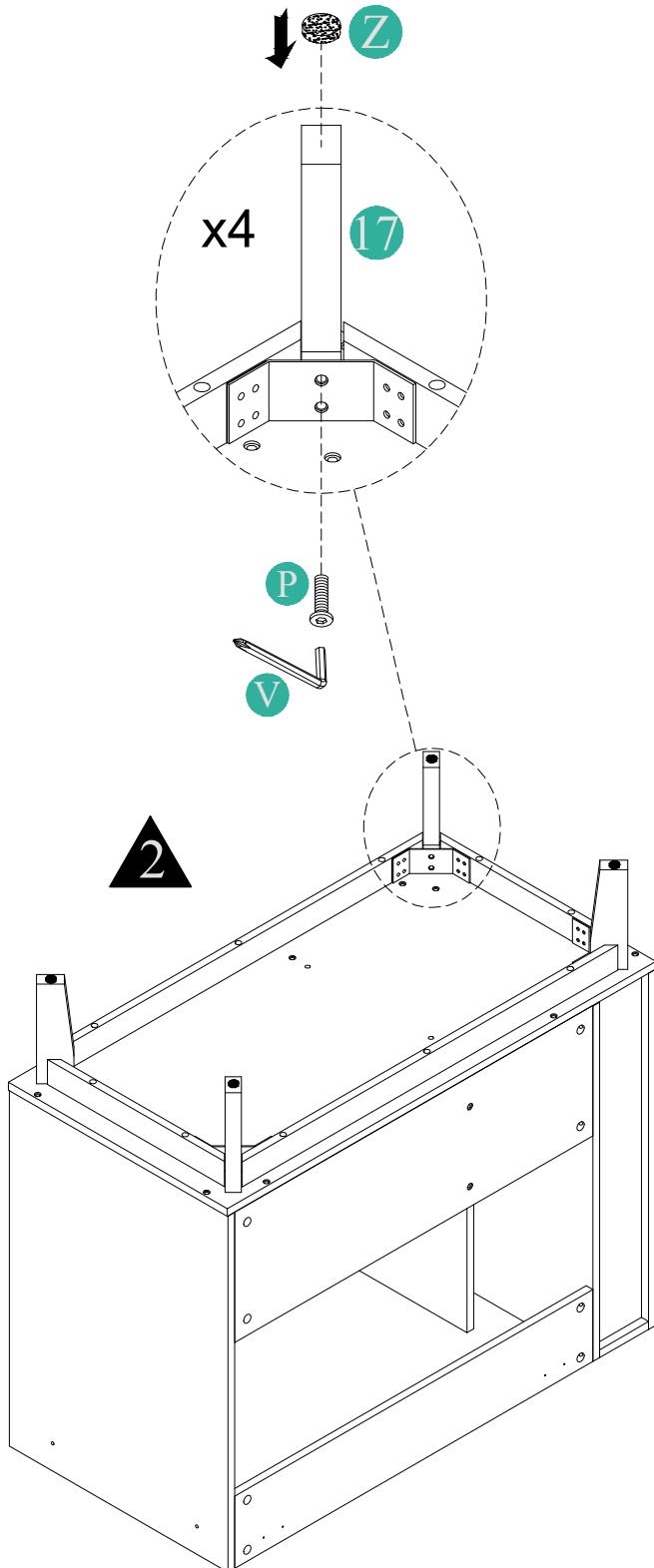

22

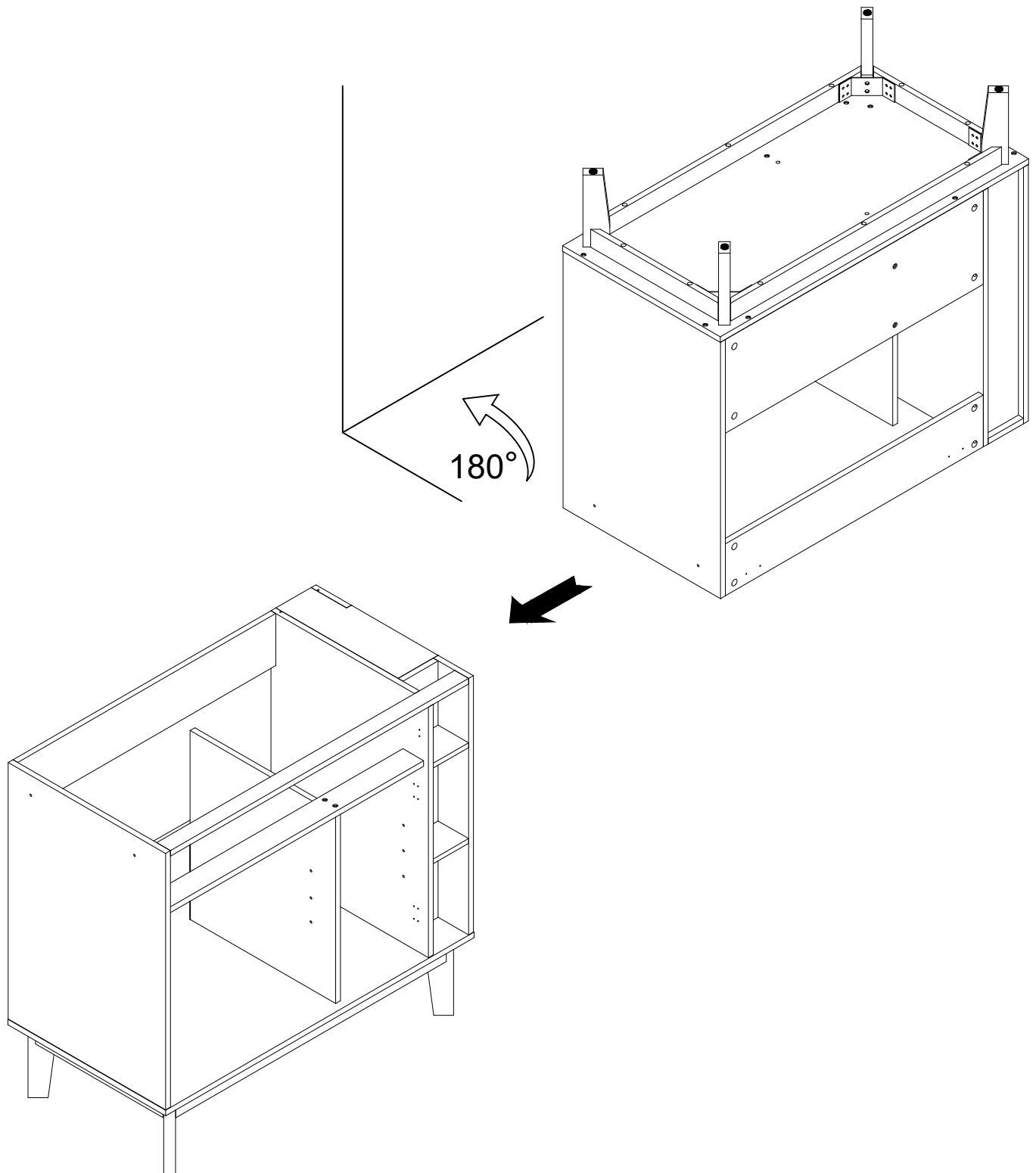

ASSEMBLY

23

Ø3.5x12MM



White color

G x4



H x2

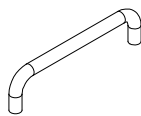

J1 x1



J2 x2

Ø4x19MM

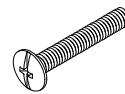

K x2

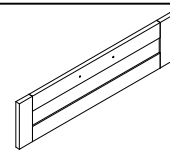

21 x1

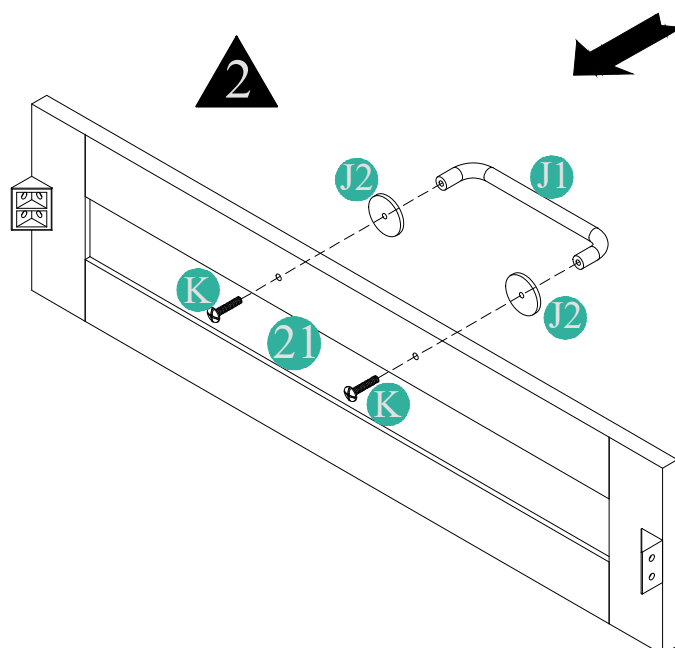
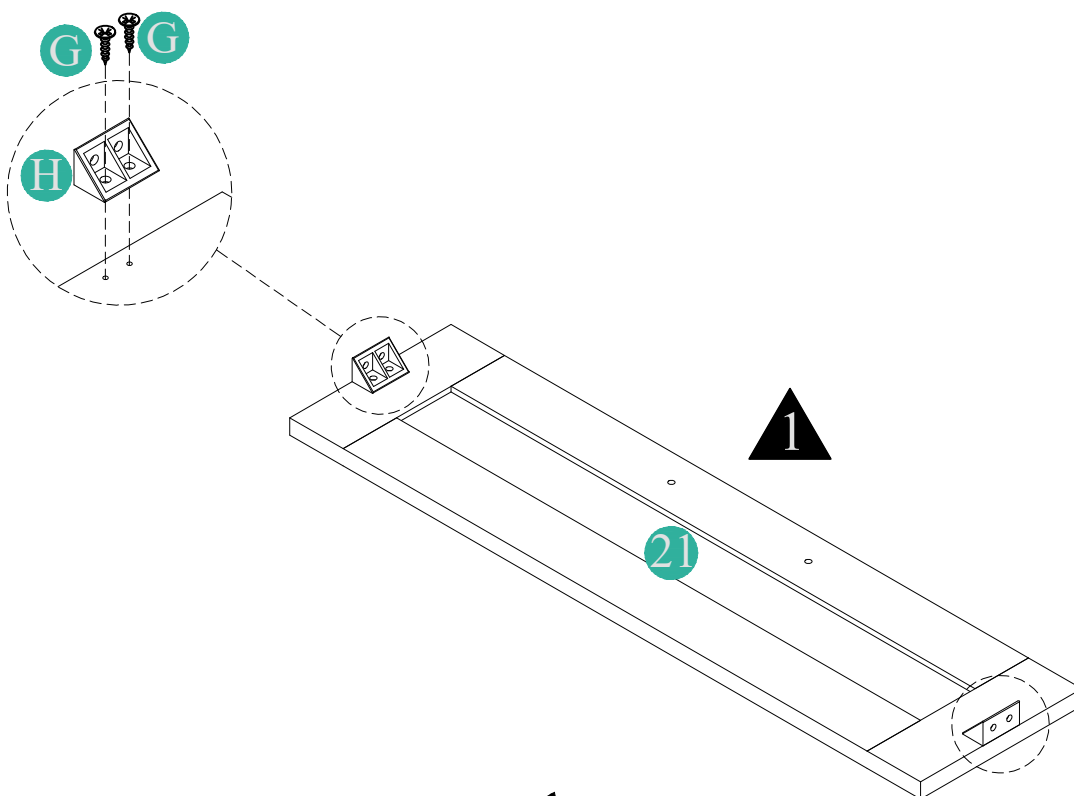

ASSEMBLY

24

Ø3.5x12MM



White color

G x4

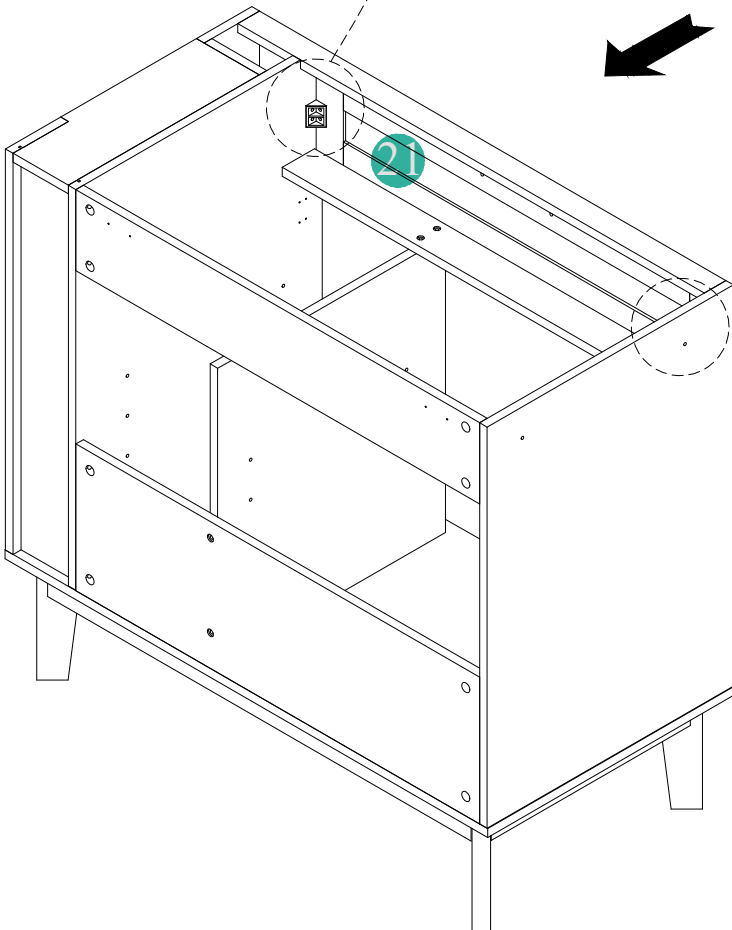
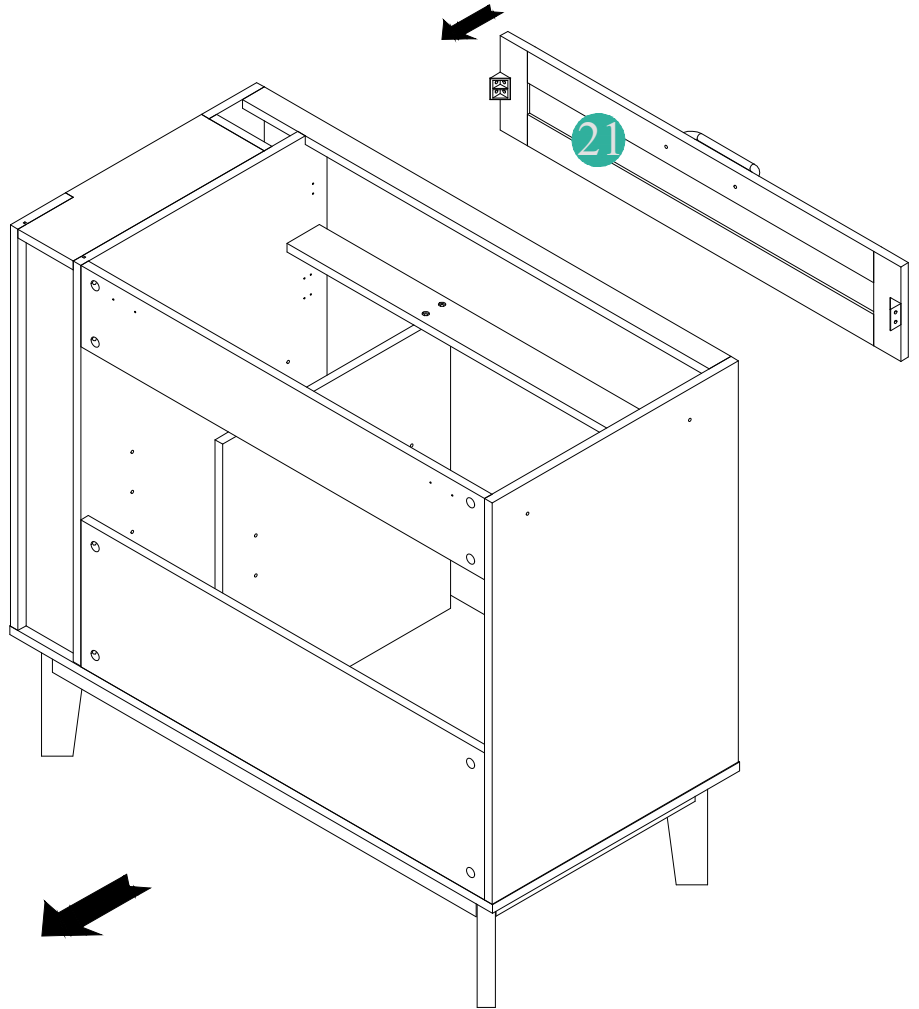
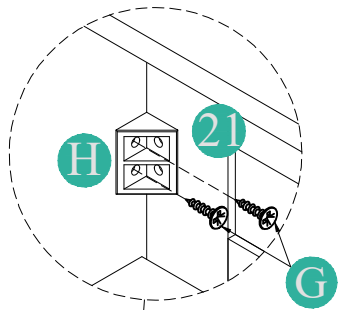

ASSEMBLY

25

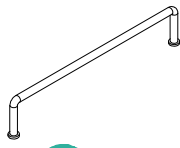

L x1

5/32x19MM

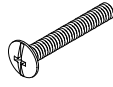

W x2

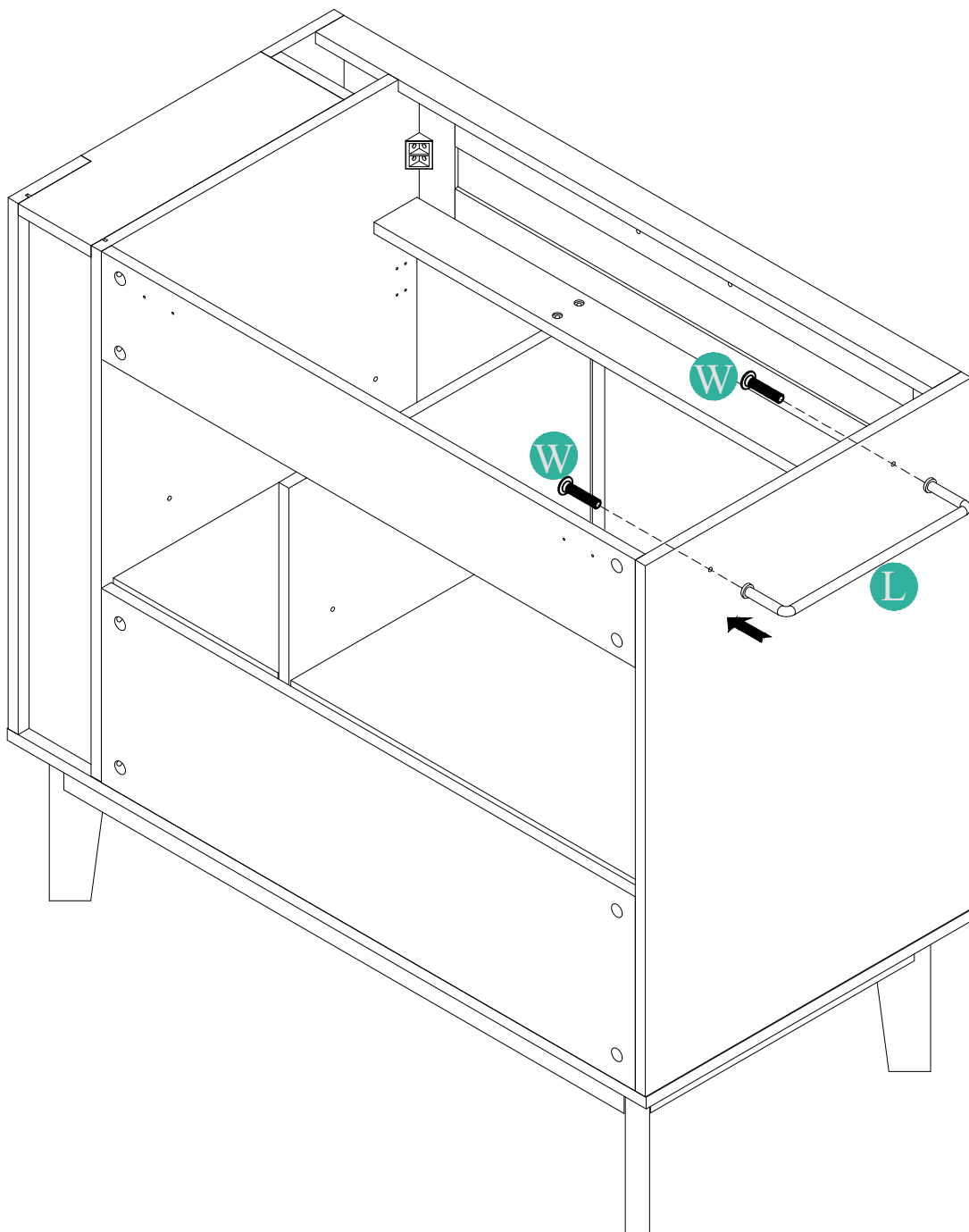

ASSEMBLY

26

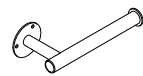

Q x1

Ø3.5x12MM



White color

G x3

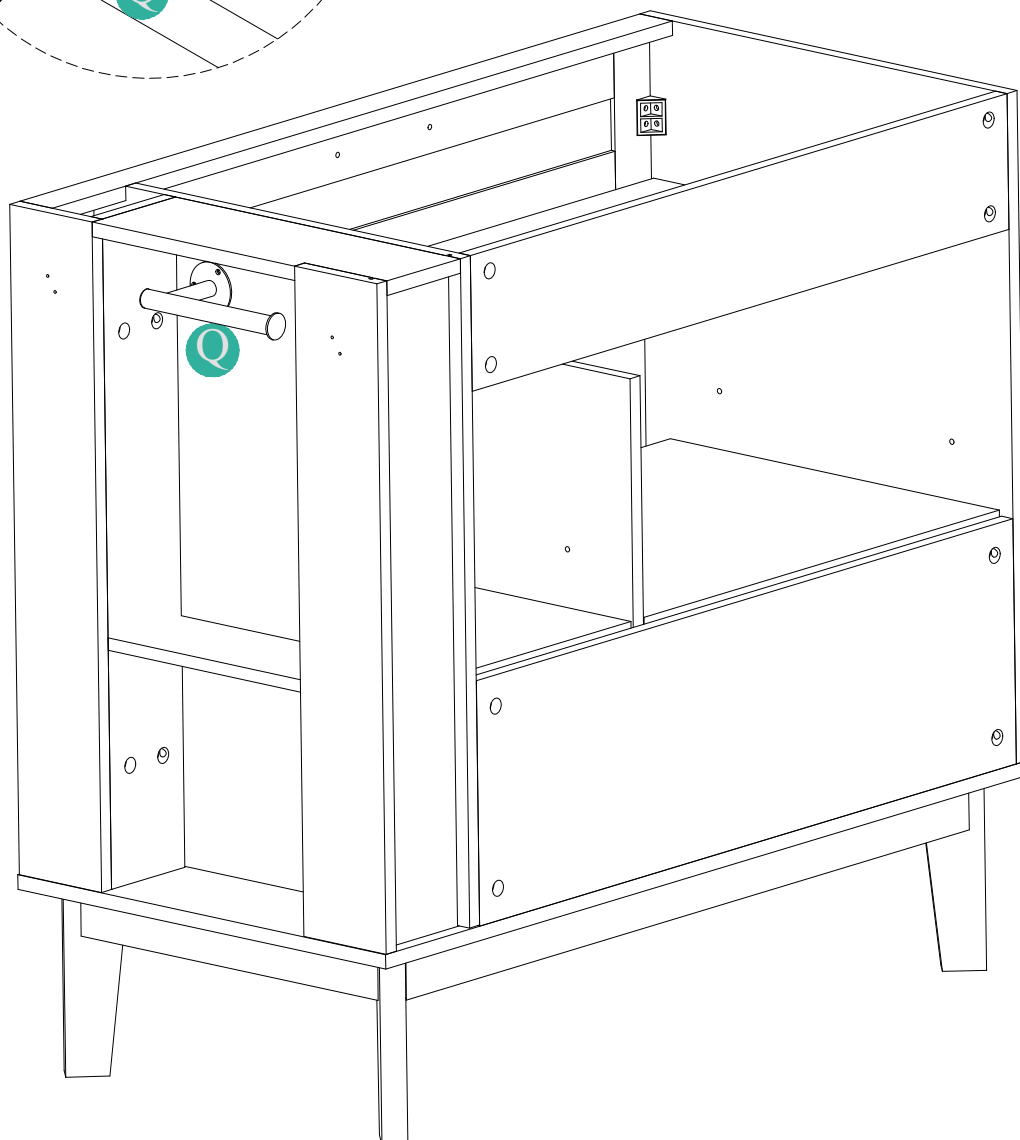
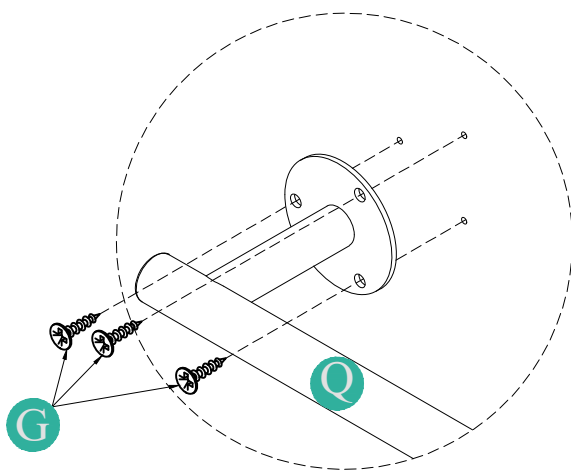

ASSEMBLY

27

Ø3.5x12MM

White color

G x8

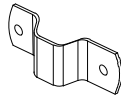

X x2

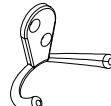

I x2

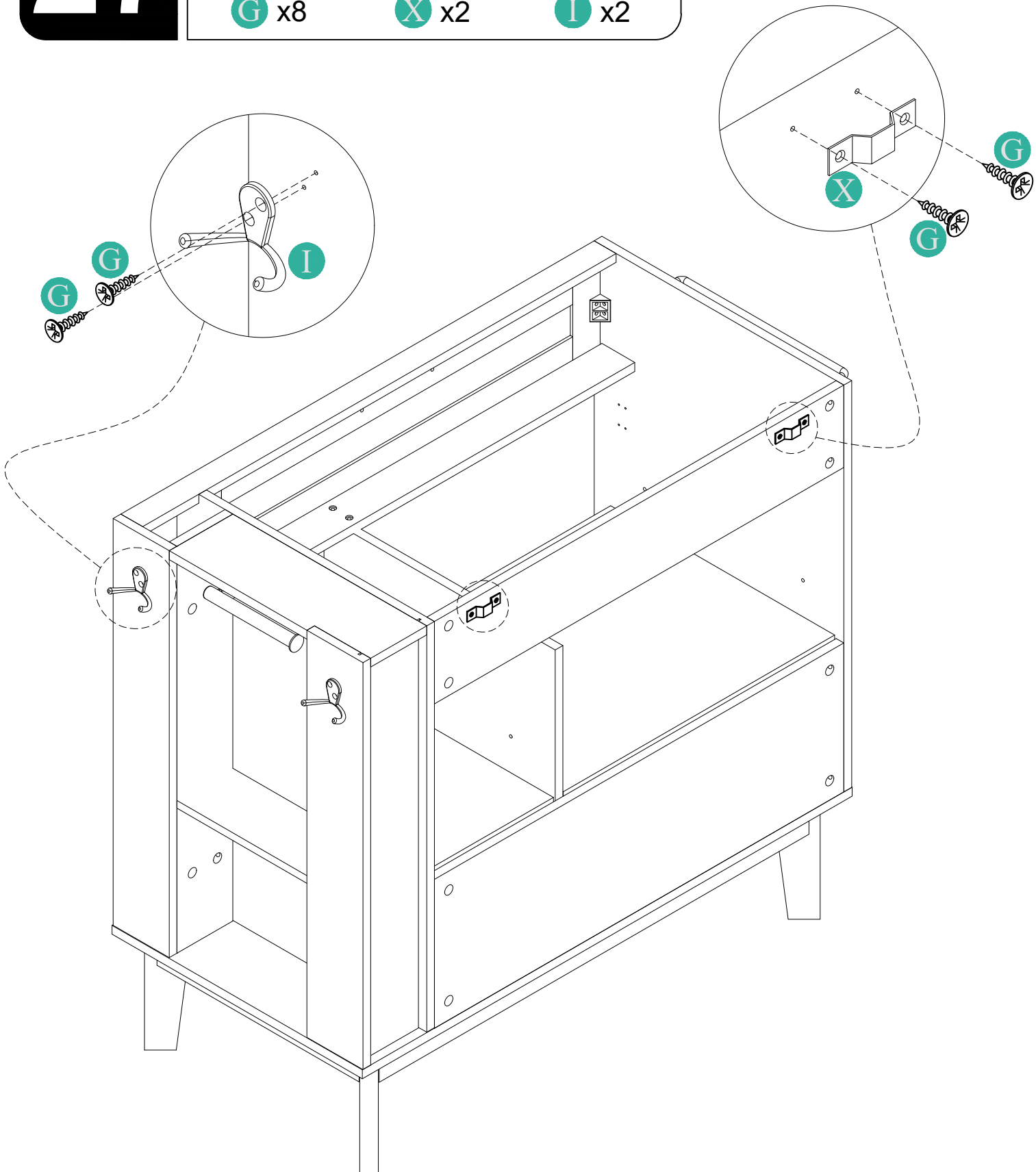

ASSEMBLY

28

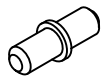

N x8

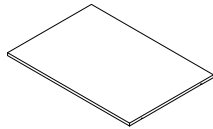

18 x1

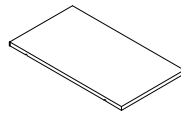

19 x1

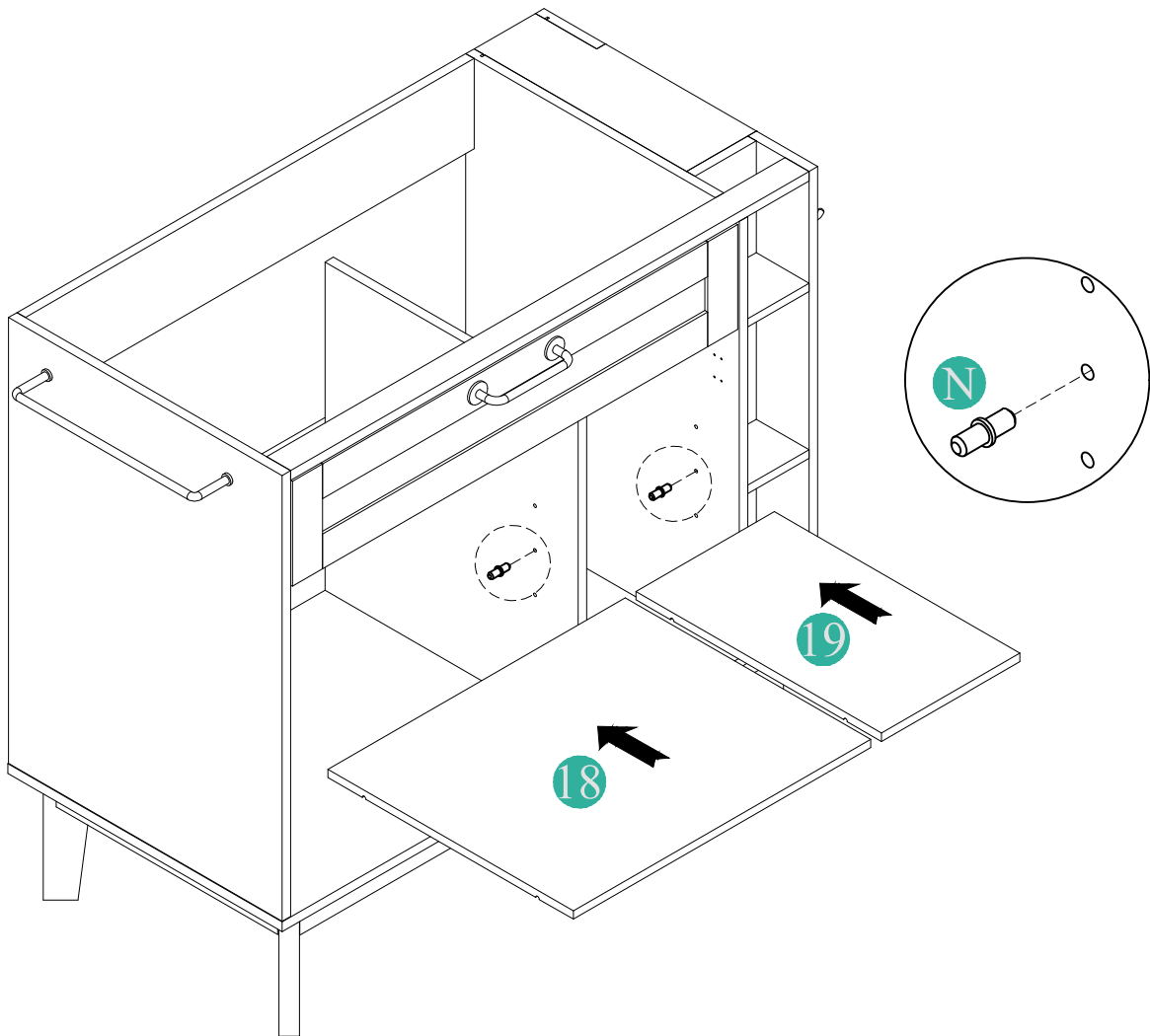

ASSEMBLY

29



E x6

Ø3.5x12MM



White color

G x12



22 x1

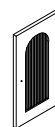

23 x2

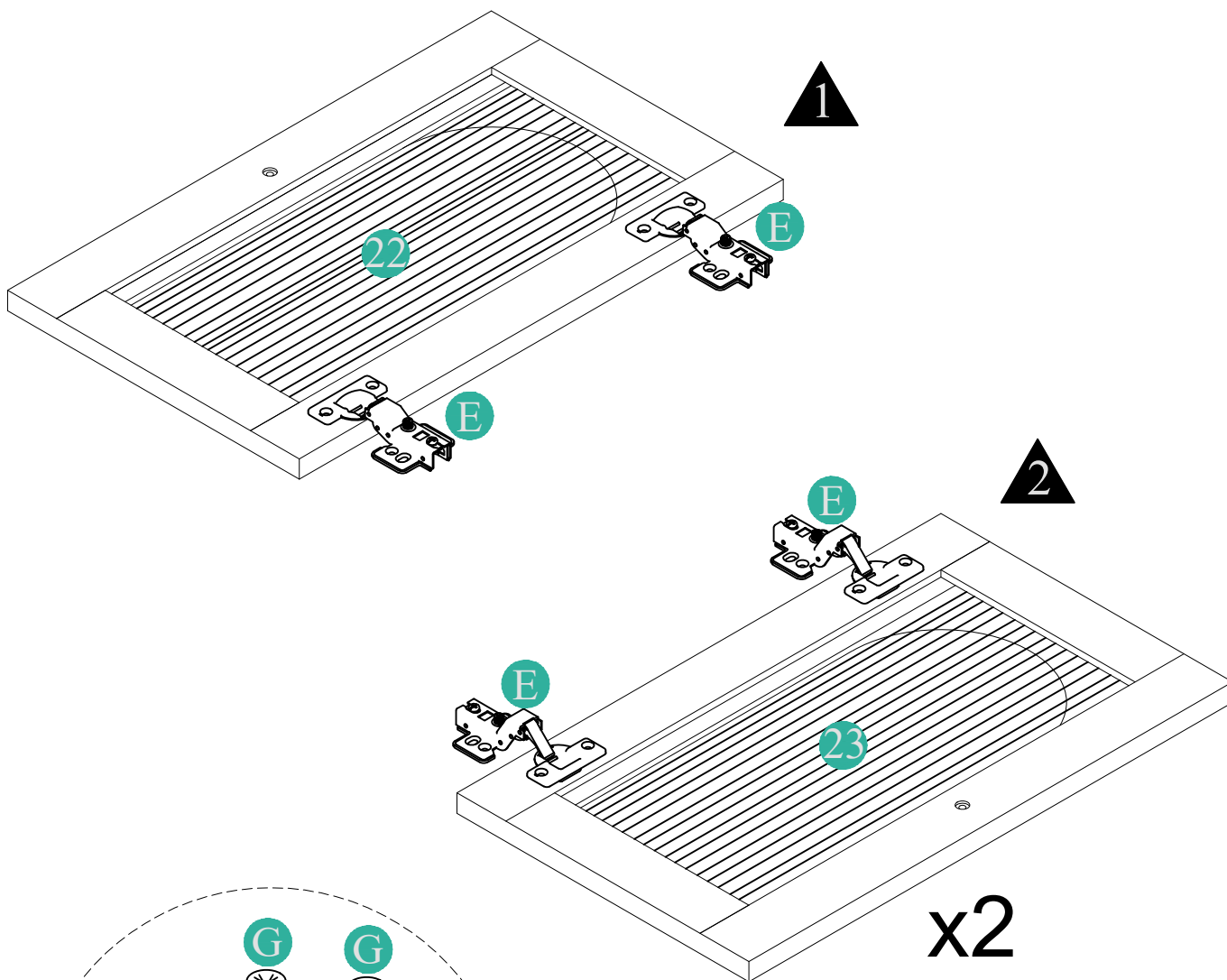

ASSEMBLY

30

Ø3.5x12MM



White color

G x8



M x1

Ø4x19MM

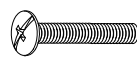

K x1

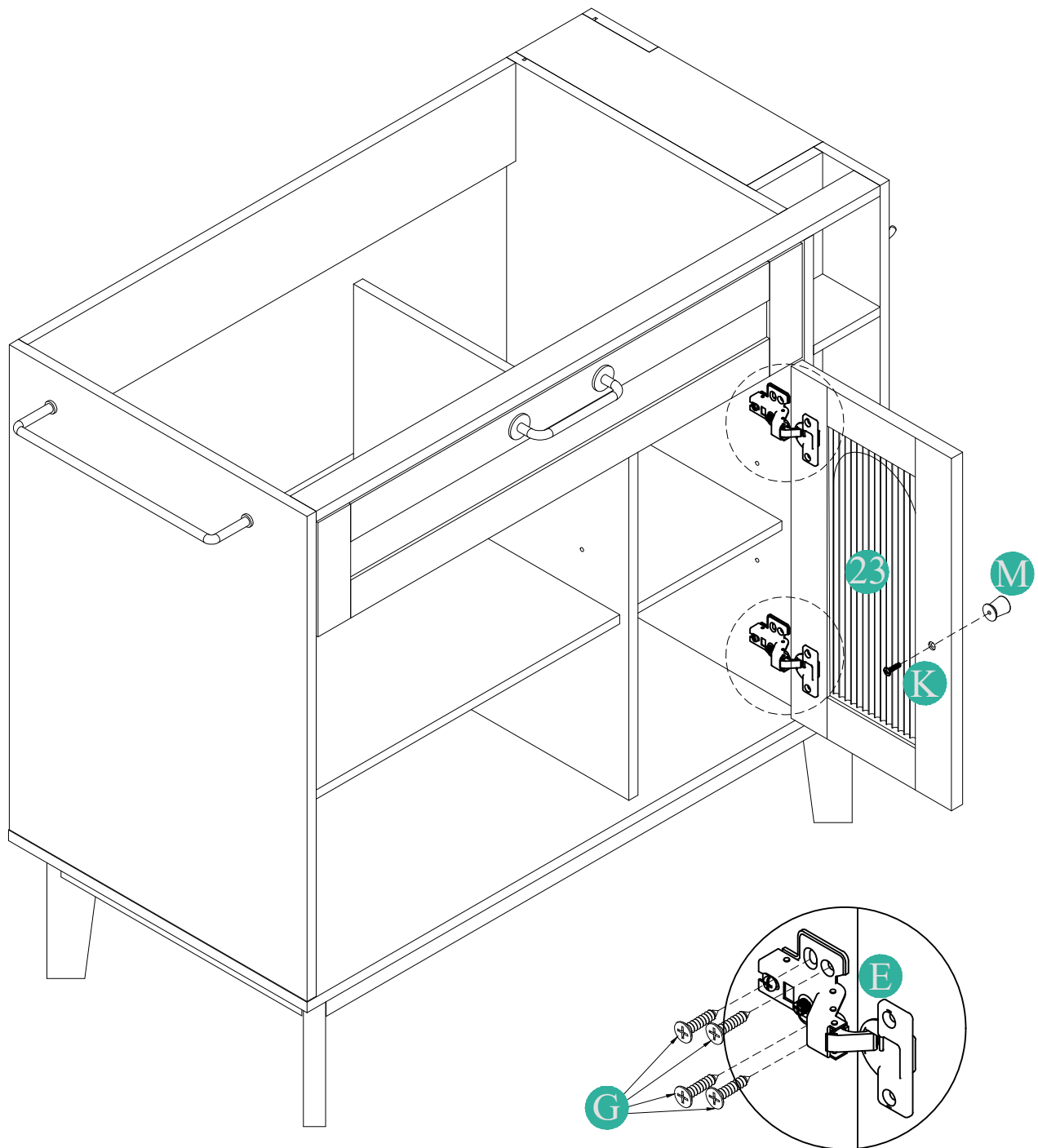

ASSEMBLY

31

Ø3.5x12MM



White color

G x16



M x2

Ø4x19MM



K x2

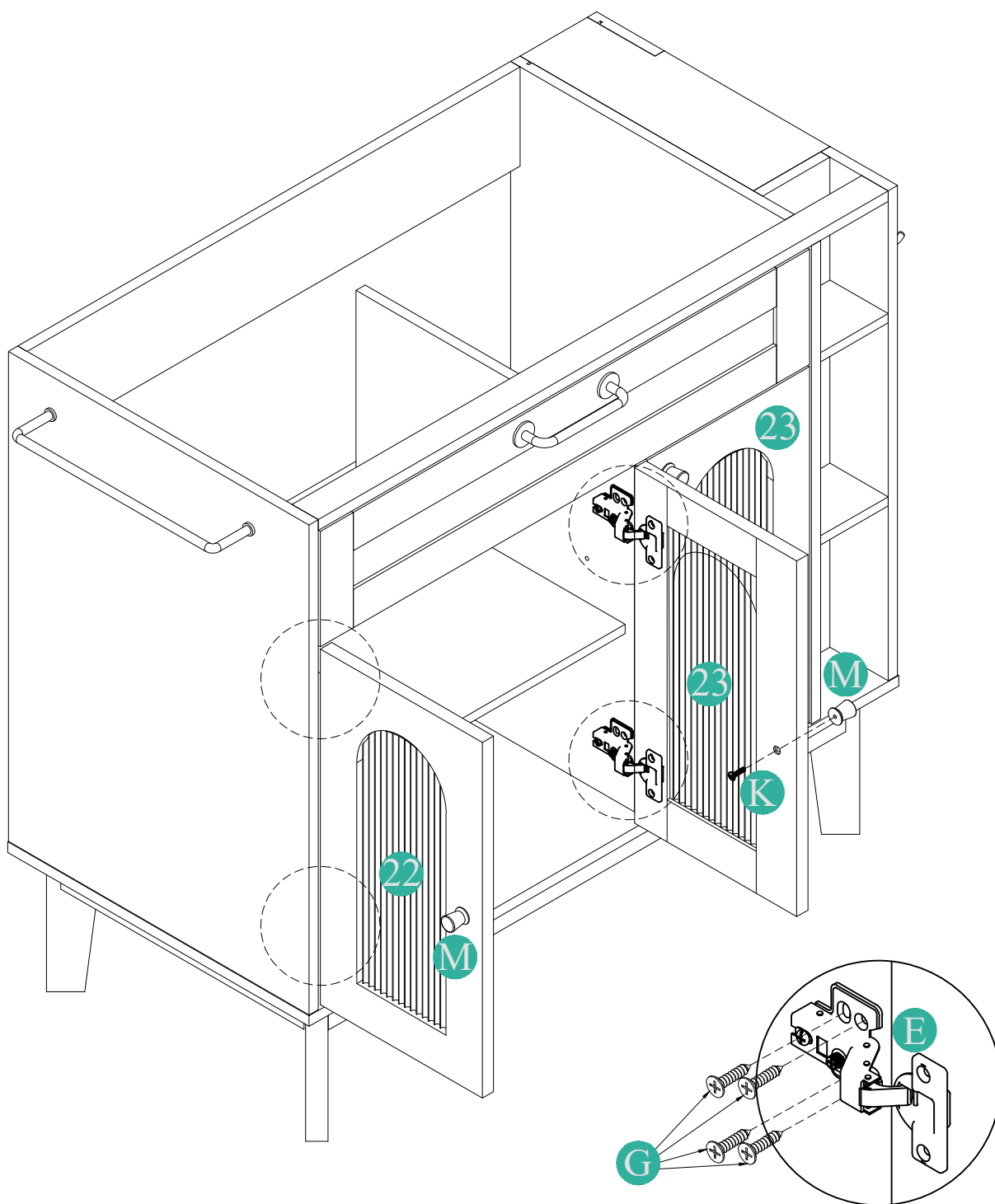

32

EN:After the door panel is installed, if the gap of the door is too large or too small, you can adjust this screw to adjust the gap of the door.

DE:Wenn der Türspalt nach der Montage des Türblatts zu groß oder zu klein ist, können Sie ihn mit dieser Schraube anpassen.

FR:Une fois le panneau de porte installé, si l'espace de la porte est trop grand ou trop petit, vous pouvez ajuster cette vis pour ajuster l'espace de la porte.

IT:Dopo aver installato il pannello della porta, se la fessura della porta è troppo grande o troppo piccola, è possibile regolare questa vite per regolare la fessura della porta.

ES:Después de instalar el panel de la puerta, si el espacio entre la puerta y el panel es demasiado grande o demasiado pequeño, puede ajustar este tornillo para ajustarlo.

EN:Adjust this screw to make the door go up or down.

DE:Stellen Sie diese Schraube ein, um die Tür nach oben oder unten zu bewegen.

FR:Ajustez cette vis pour faire monter ou descendre la porte.

IT:Regola questa vite per far salire o scendere la porta.

ES:Ajuste este tornillo para hacer que la puerta suba o baje.

EN:Adjust this screw to make the door forward or backward.

DE:Stellen Sie diese Schraube ein, um die Tür nach vorne oder hinten zu bewegen.

FR:Ajustez cette vis pour faire avancer ou reculer la porte.

IT:Regolare questa vite per spostare la porta in avanti o indietro.

ES:Ajuste este tornillo para mover la puerta hacia adelante o hacia atrás.

EN:Adjust this screw to make the door turn left or right.

DE:Stellen Sie diese Schraube ein, um die Tür nach links oder rechts zu drehen.

FR:Ajustez cette vis pour faire tourner la porte à gauche ou à droite.

IT:Regolare questa vite per far girare la porta a sinistra o a destra.

ES:Ajuste este tornillo para hacer que la puerta gire hacia la izquierda o hacia la derecha.

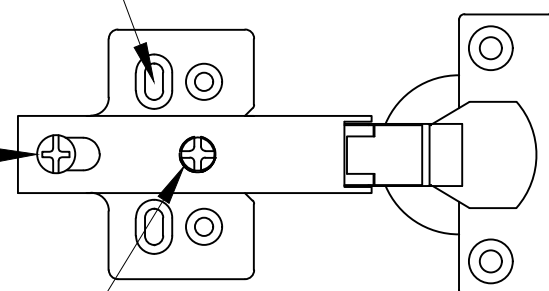

33

EN: WARNING



In order to prevent overturning this product must be used with the wall attachment device provided.

DE: WARNUNG

Um ein Umkippen zu verhindern, muss dieses Produkt mit der mitgelieferten Wandmontagevorrichtung verwendet werden.

FR: AVERTISSEMENT

Pour éviter tout risque de basculement, ce produit doit être utilisé avec les fixations murales fournies.

IT: ATTENZIONE

Per evitare il ribaltamento, questo prodotto deve essere utilizzato con i fissaggi a parete forniti.

ES: ADVERTENCIA

Para evitar vuelcos, este producto debe utilizarse con las fijaciones de pared suministradas.

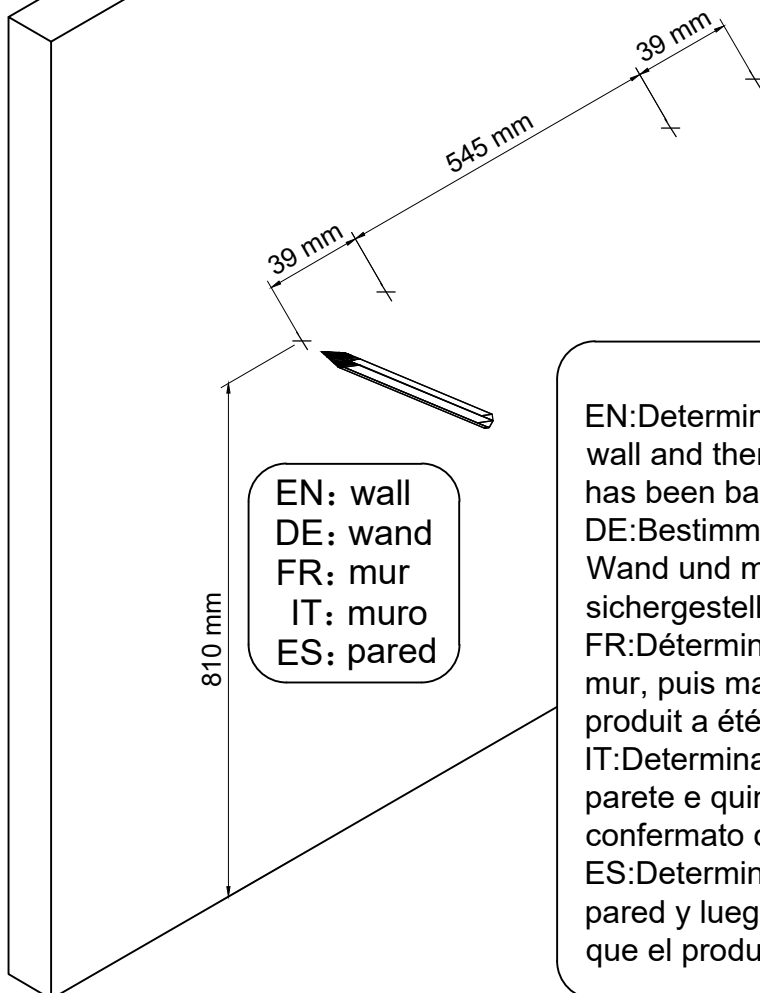

EN: wall
DE: wand
FR: mur
IT: muro
ES: pared

STEP 1

EN: Determine the location of the anti-overturning on the wall and then mark the position after confirming the product has been balanced.

DE: Bestimmen Sie die Position der Kippsicherung an der Wand und markieren Sie die Position, nachdem Sie sichergestellt haben, dass das Produkt ausbalanciert ist.

FR: Déterminez l'emplacement de l'anti-renversement sur le mur, puis marquez la position après avoir confirmé que le produit a été équilibré.

IT: Determinare la posizione dell'antiribaltamento sulla parete e quindi contrassegnare la posizione dopo aver confermato che il prodotto è stato bilanciato.

ES: Determine la ubicación del dispositivo antivuelco en la pared y luego marque la posición después de confirmar que el producto esté equilibrado.

34

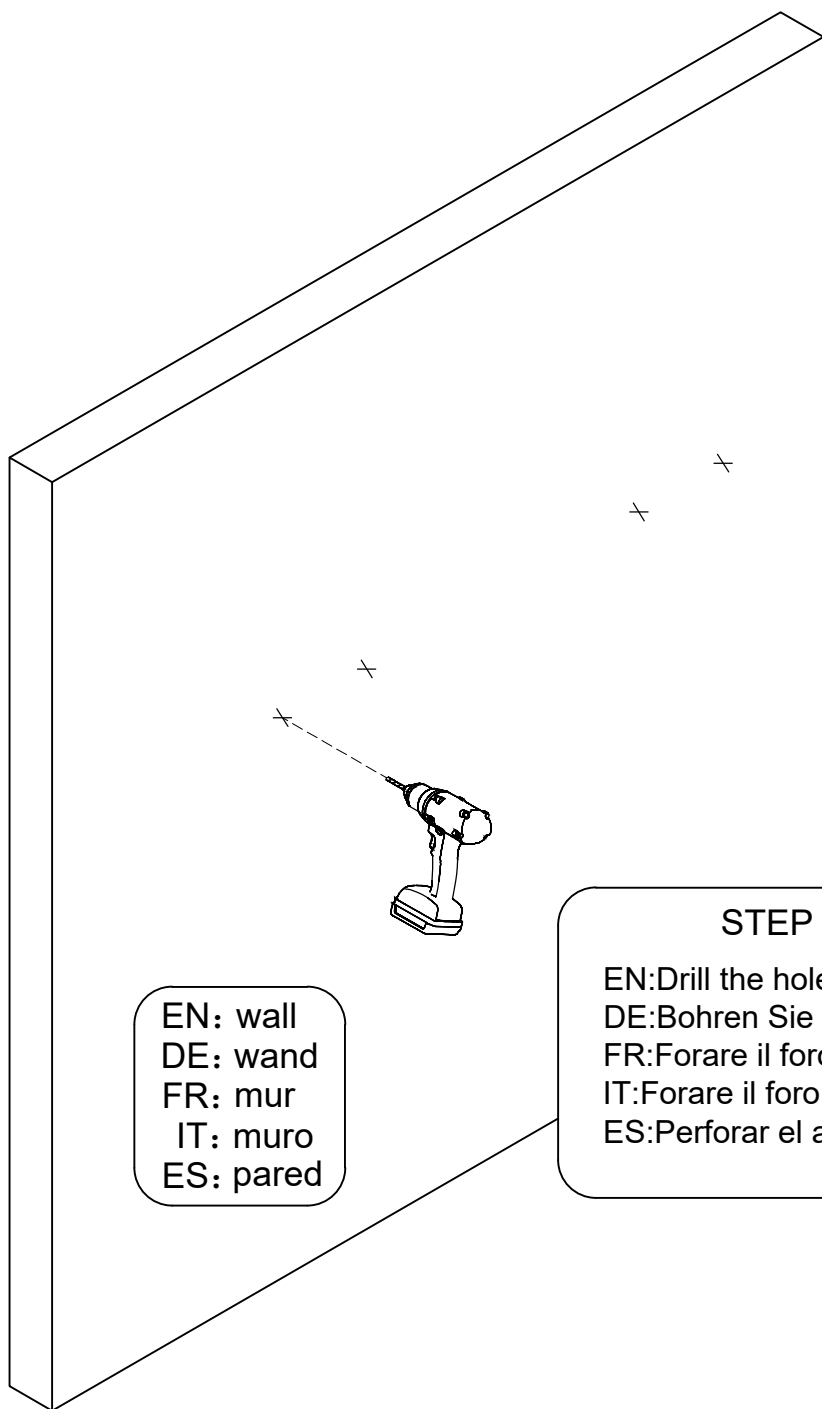

EN: wall
DE: wand
FR: mur
IT: muro
ES: pared

STEP 2

EN: Drill the hole.
DE: Bohren Sie das Loch.
FR: Forare il foro.
IT: Forare il foro.
ES: Perforar el agujero.

ASSEMBLY

35

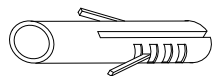

R x4

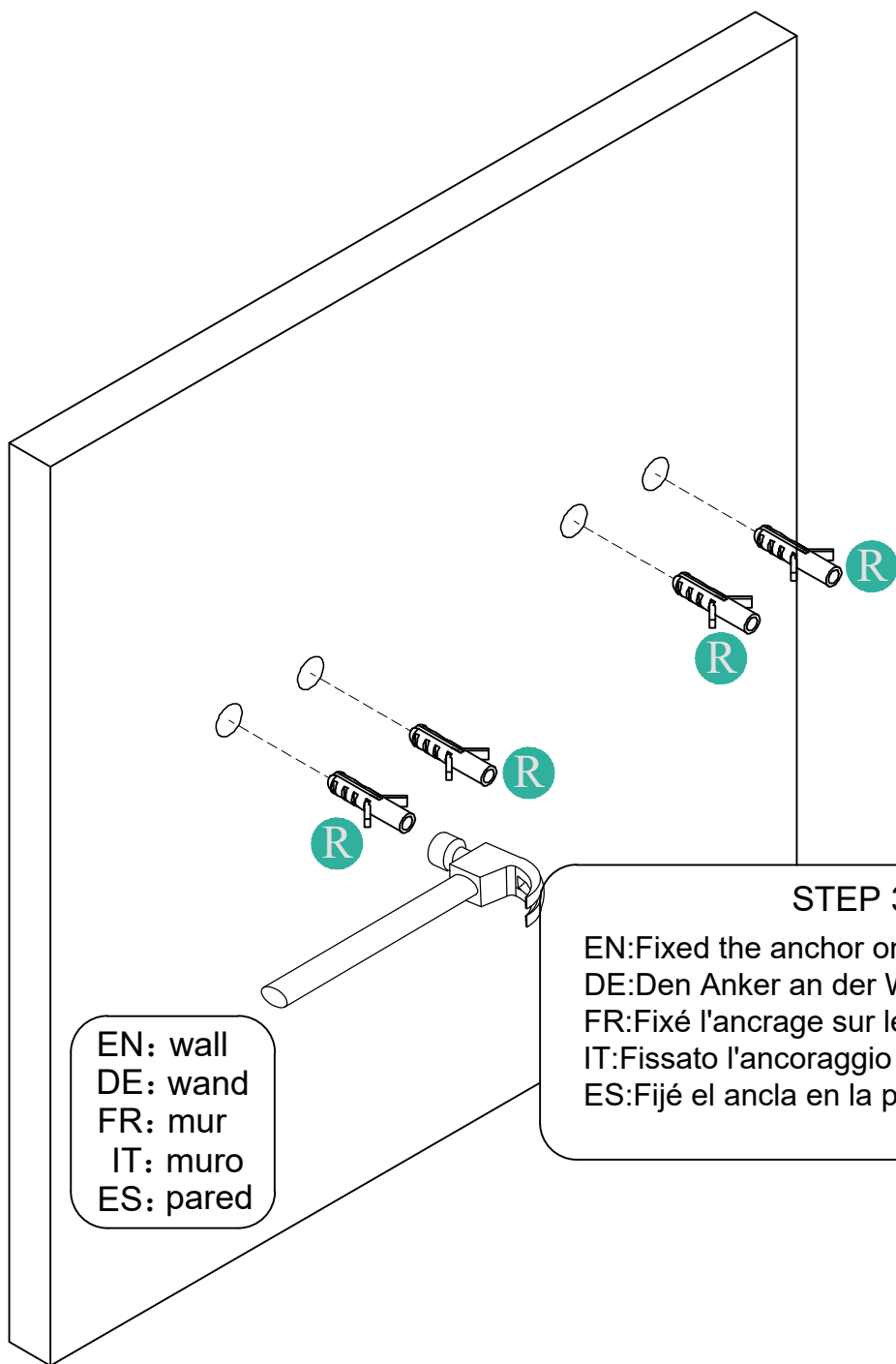

STEP 3

EN: Fixed the anchor on the wall.
DE: Den Anker an der Wand befestigen.
FR: Fixé l'ancrage sur le mur.
IT: Fissato l'ancoraggio al muro.
ES: Fijé el ancla en la pared.

EN: wall
DE: wand
FR: mur
IT: muro
ES: pared

ASSEMBLY

36

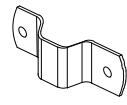

X x2

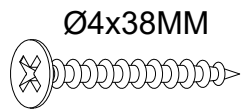

S x4

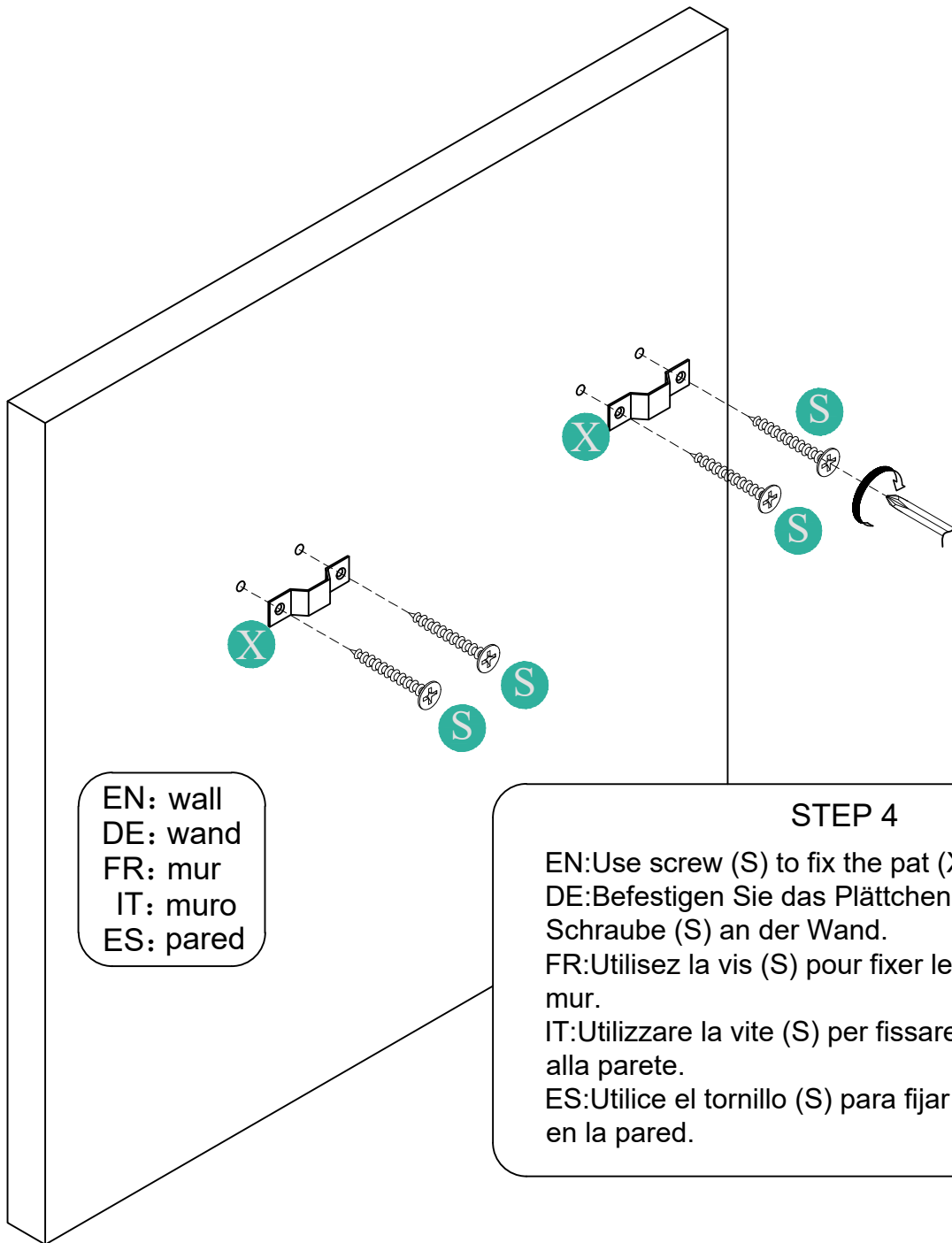

EN: wall
DE: wand
FR: mur
IT: muro
ES: pared

STEP 4

EN: Use screw (S) to fix the pat (X) on the wall.
DE: Befestigen Sie das Plättchen (X) mit der Schraube (S) an der Wand.
FR: Utilisez la vis (S) pour fixer le pat (X) sur le mur.
IT: Utilizzare la vite (S) per fissare il tassello (X) alla parete.
ES: Utilice el tornillo (S) para fijar la placa (X) en la pared.

ASSEMBLY

37



T x2

STEP 5

EN: Use cable tie (T) to fix (X) and (X).
DE: Befestigen Sie (X) und (X) mit Kabelbinder (T).
FR: Utilisez le serre-câble (T) pour fixer (X) et (X).
IT: Utilizzare la fascetta (T) per fissare (X) e (X).
ES: Utilice la brida (T) para fijar (X) y (X).

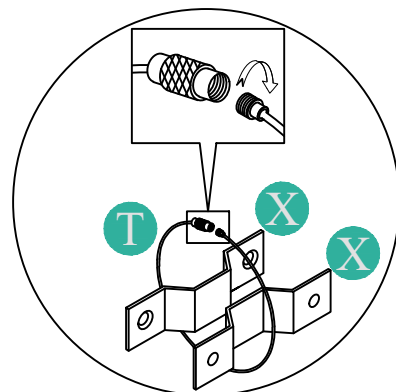

EN: wall
DE: wand
FR: mur
IT: muro
ES: pared

38

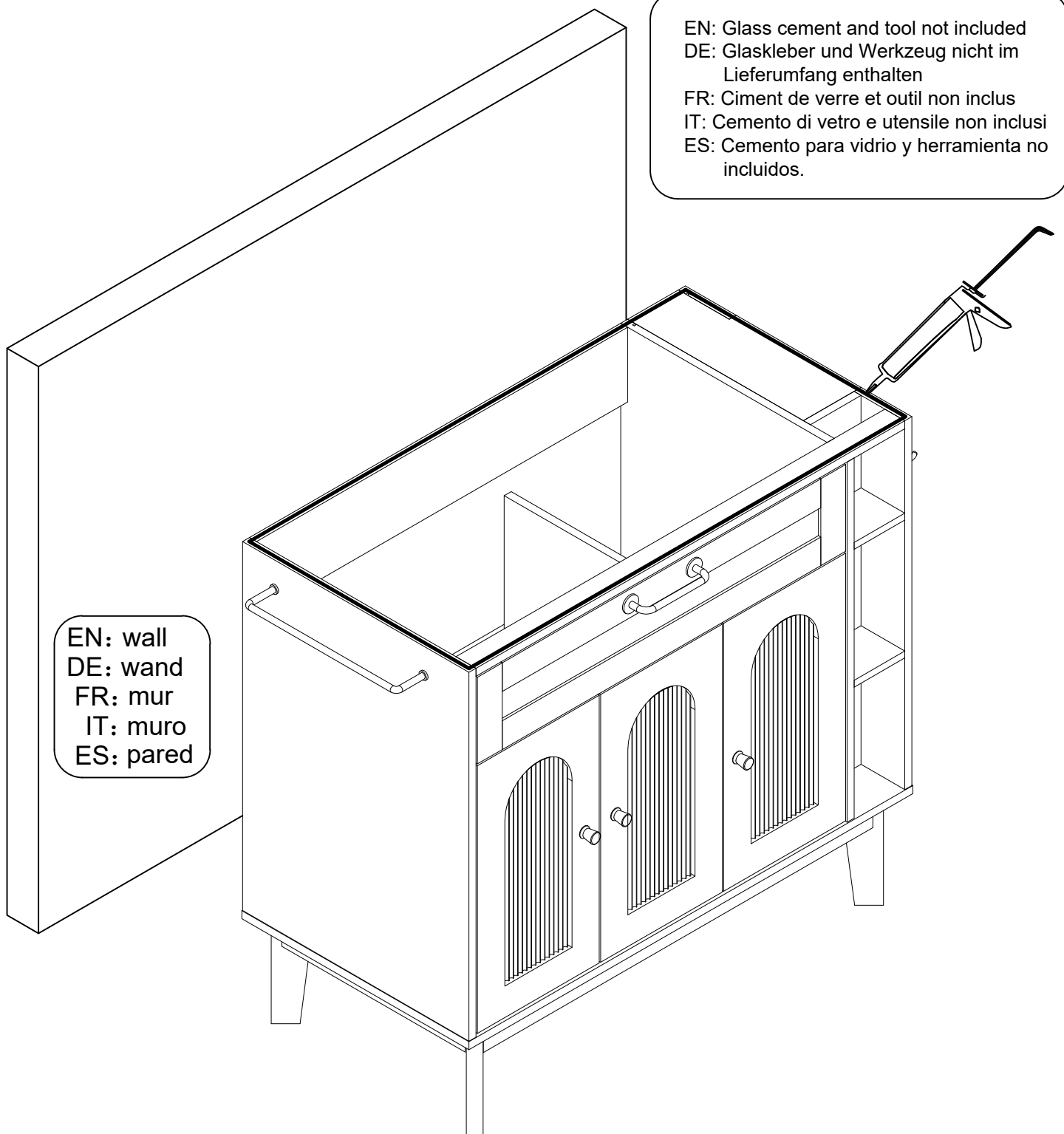

ASSEMBLY

39

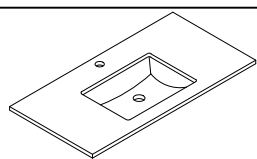

24 x1

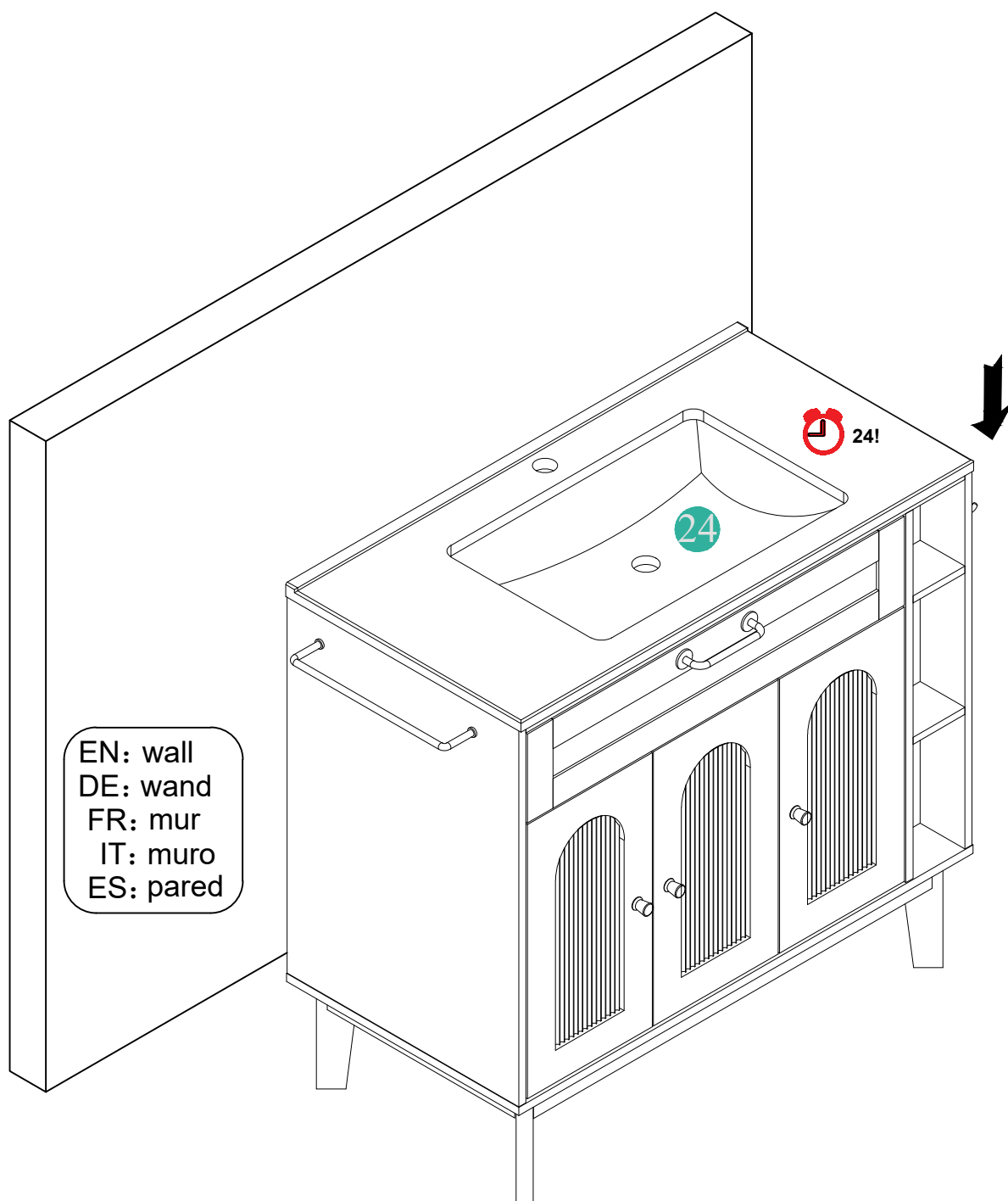

EN: wall
DE: wand
FR: mur
IT: muro
ES: pared

KING YUAN TONG WOOD CO., LTD.

N3 & N4 road, Nam Tan Uyen Industrial Park expansion, Binh Co wards, Ho Chi Minh City, VN.

Date of manufacture :2025/09