

MODERN EMBER

Raeford Stone Mantel

Model: ME-M-STN-RAE

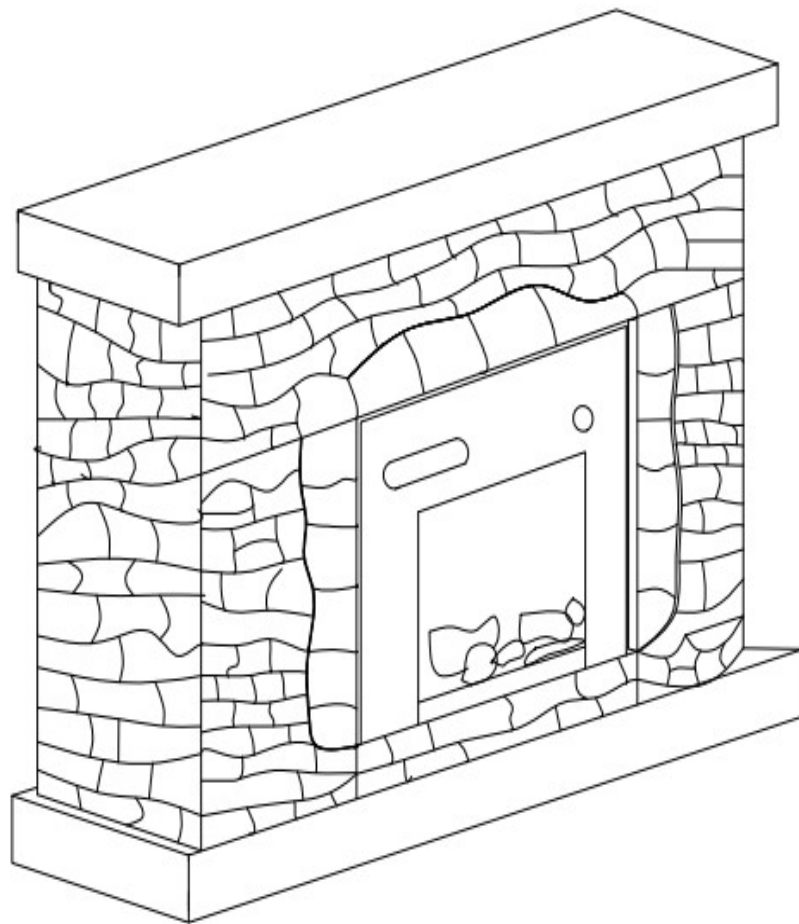

SAFETY INFORMATION



Please read and understand the entire manual before attempting to assemble, install, or operate the product.



WARNING! You may need an adult to assist with some steps.



CAUTION!

Before assembly and installation, carefully unwrap all parts. Locate and set aside the hardware kit before disposing of the packaging.

Use care when assembling the product. Take your time and follow the instructions closely.



WARNING!

Do not use more than the maximum load as shown in the diagram. The use of TVs or loads heavier than the maximum weights specified may result in instability, causing tip over, which could result in serious injury or death.

Maximum load 99 lbs.

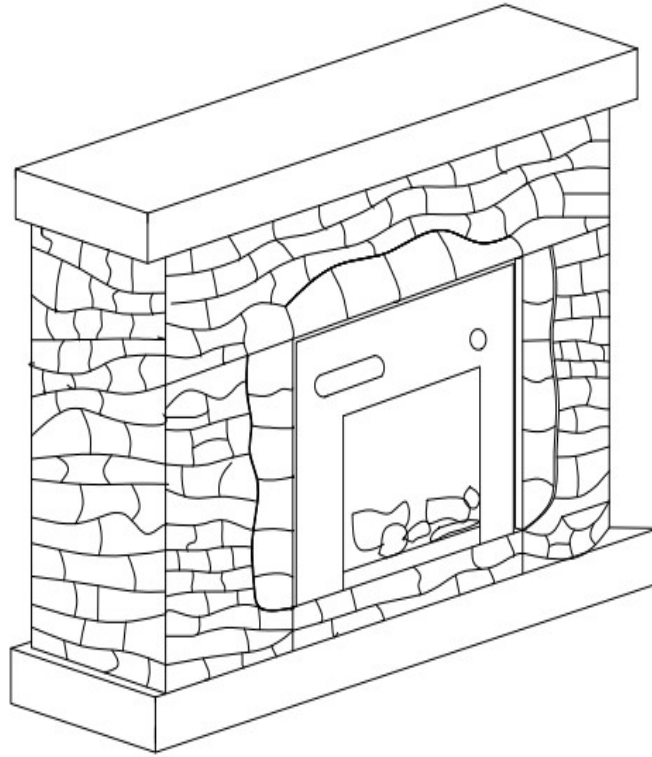

Questions, problems, missing parts?

Before returning to store, call

Customer Service:

8am-5pm CST, Monday – Friday

Phone: 877-430-0703

Email: resolutions@electricfireplacesdirect.com

Please save these instructions for future reference.

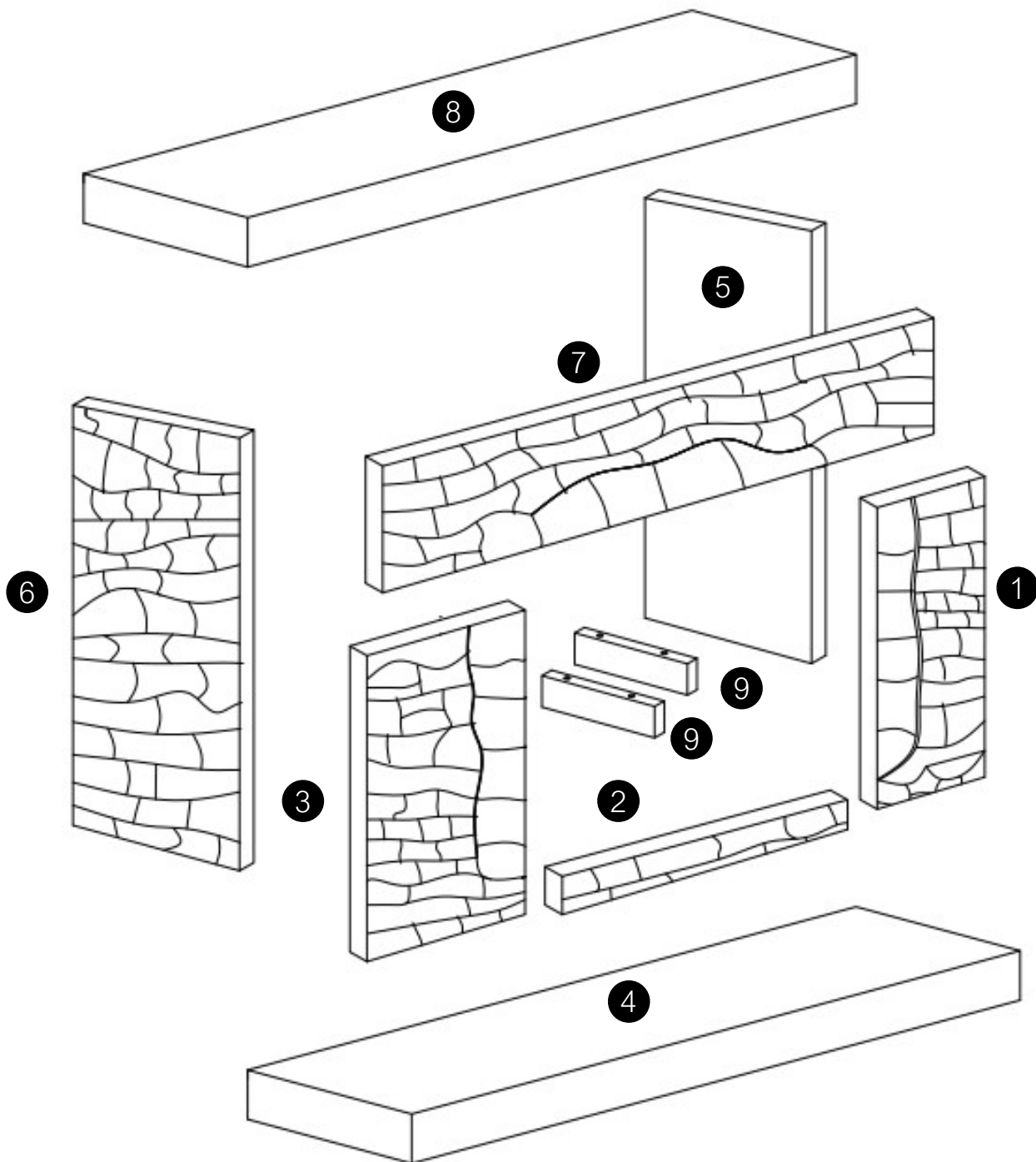

TOOLS NEEDED



Philips Head Screwdriver
(not included)









Drill
(not included)



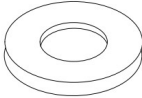

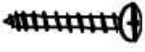

Hammer
(not included)

PARTS

PART NO.	DESCRIPTION	QTY
1	Front Right Panel	1
2	Riser	1
3	Front Left Panel	1
4	Hearth	1
5	Right Side Panel	1
6	Left Side Panel	1
7	Header	1
8	Top Shelf	1
9	Insert Support Rail	2

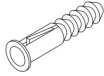

HARDWARE		
PART NO.	DESCRIPTION	QTY
A	Machine Screw 	36
B	Washer 	36
C	Connecting Plate 	4
D	L-Bracket 	8
E	Top Corner Bracket 	2
F	Base Corner Bracket 	2
G	Long Wood Screw 	4
H	Insert Connecting Plate 	2
I	Short Wood Screw 	4

ANTI-TIPPING HARDWARE

PART NO.	DESCRIPTION	QTY
J	Tie 	1
K	Bracket 	2
L	Anchor 	2
M	Long Screw 	2
N	Short Screw 	2

Note: Anti-tipping hardware will be in a separate pack.

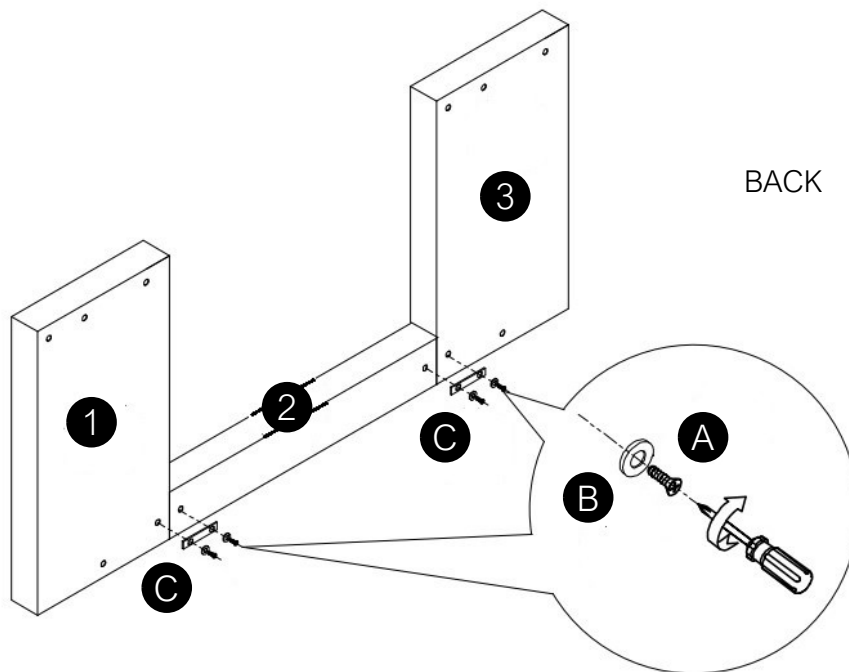

STEP 1

PART NO.	DESCRIPTION		QTY
A	Machine Screw		4
B	Washer		4
C	Connecting Plate		2



Carefully lay the Front Right Panel (1), Riser (2), and Front Left Panel (3) on a flat, carpeted surface. (If you do not have carpet, use a blanket or other soft surface to help prevent the panels from being scratched during assembly.) Align the holes on the Front Right Panel (1) with the corresponding holes on the Riser (2). Secure the panels together using a connecting plate (C), 2 washers (B), and 2 screws (A). Repeat with the Riser (2) and Front Left Panel (3). Do not overtighten.

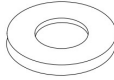

STEP 2

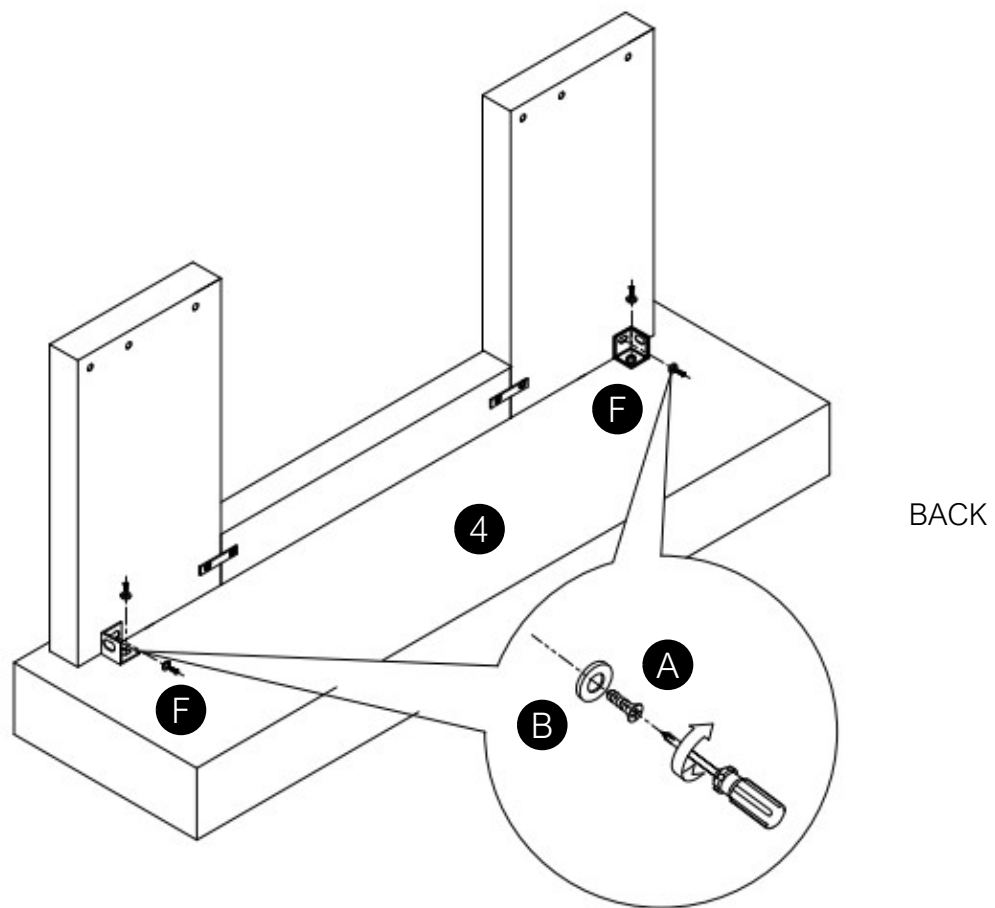
PART NO.	DESCRIPTION		QTY
A	Machine Screw		4
B	Washer		4
F	Base Corner Bracket		2



Carefully set the assembled panels (1, 2 & 3) onto the Hearth 4. Secure the panels to the Hearth (4) with 2 base corner brackets (F), 4 washers (B), and 4 screws (A). Do not overtighten.

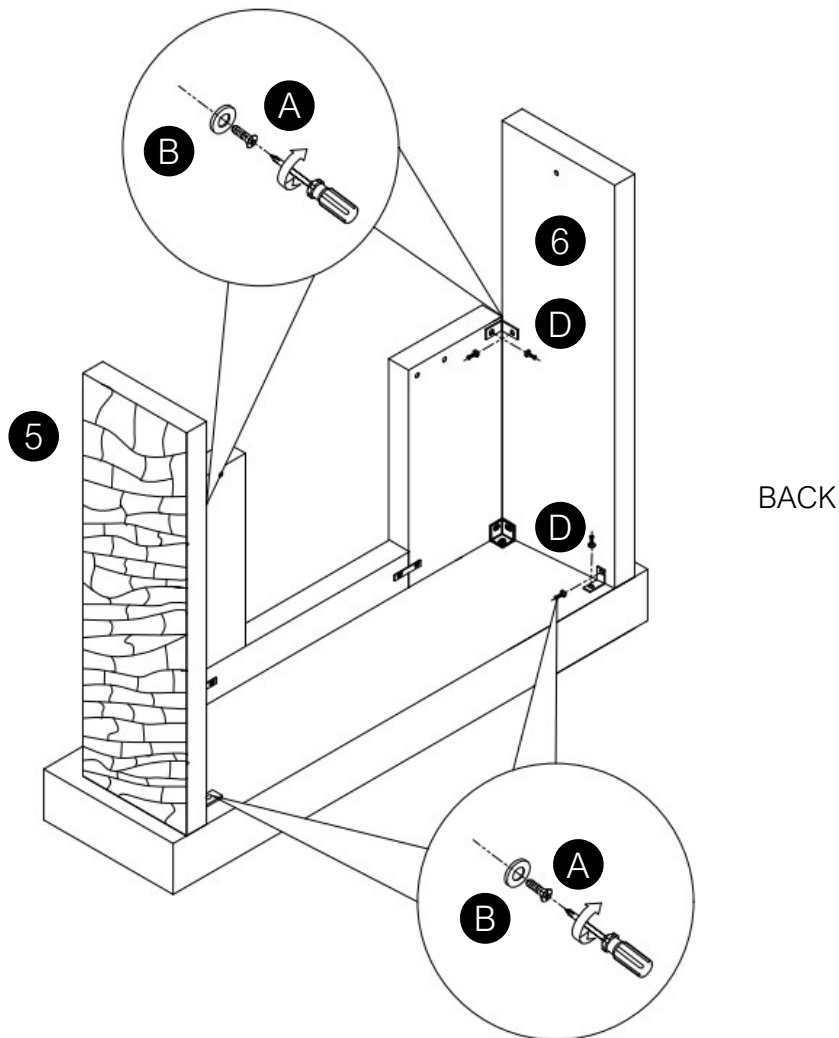

STEP 3

PART NO.	DESCRIPTION		QTY
A	Machine Screw		8
B	Washer		8
D	L-Bracket		4



From the back side, carefully set the Right Side Panel (5) and Left Side Panel (6) onto the Hearth (4). Align the holes on each panel with the corresponding holes on the Hearth (4) and the front panels (1 & 3). Using 8 washers (B), 8 screws (A), and 4 L-brackets (D), secure the side panels (5 & 6) to the Hearth (4) and front panels (1 & 3). Do not overtighten.

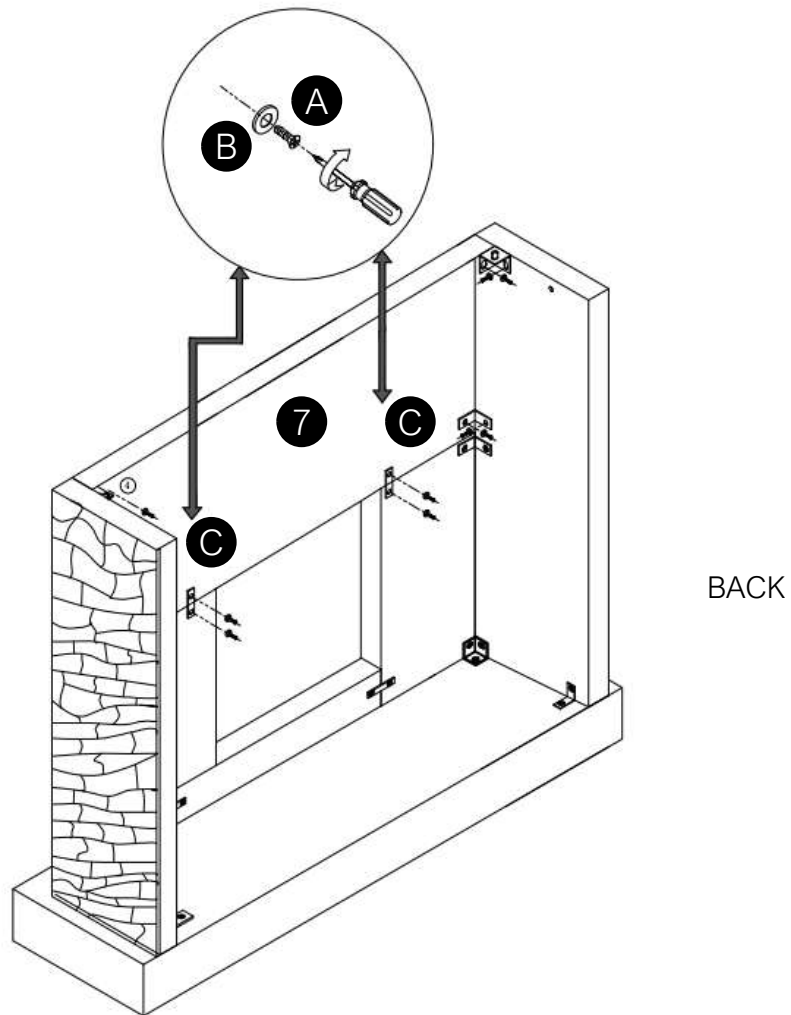

STEP 4

PART NO.	DESCRIPTION		QTY
A	Machine Screw		4
B	Washer		4
C	Connecting Plate		2



Carefully slide the Header (7) on top of the assembled panels (1, 2 & 3) and in between the side panels (5 & 6). Align the holes with the corresponding holes on the assembled frame (1, 2, 3, 4, 5 & 6). Using 2 connecting plates (C), 4 washers (B), and 4 screws (A), secure the Header (7) to the assembled frame (1, 2, 3, 5 & 6). Do not overtighten.

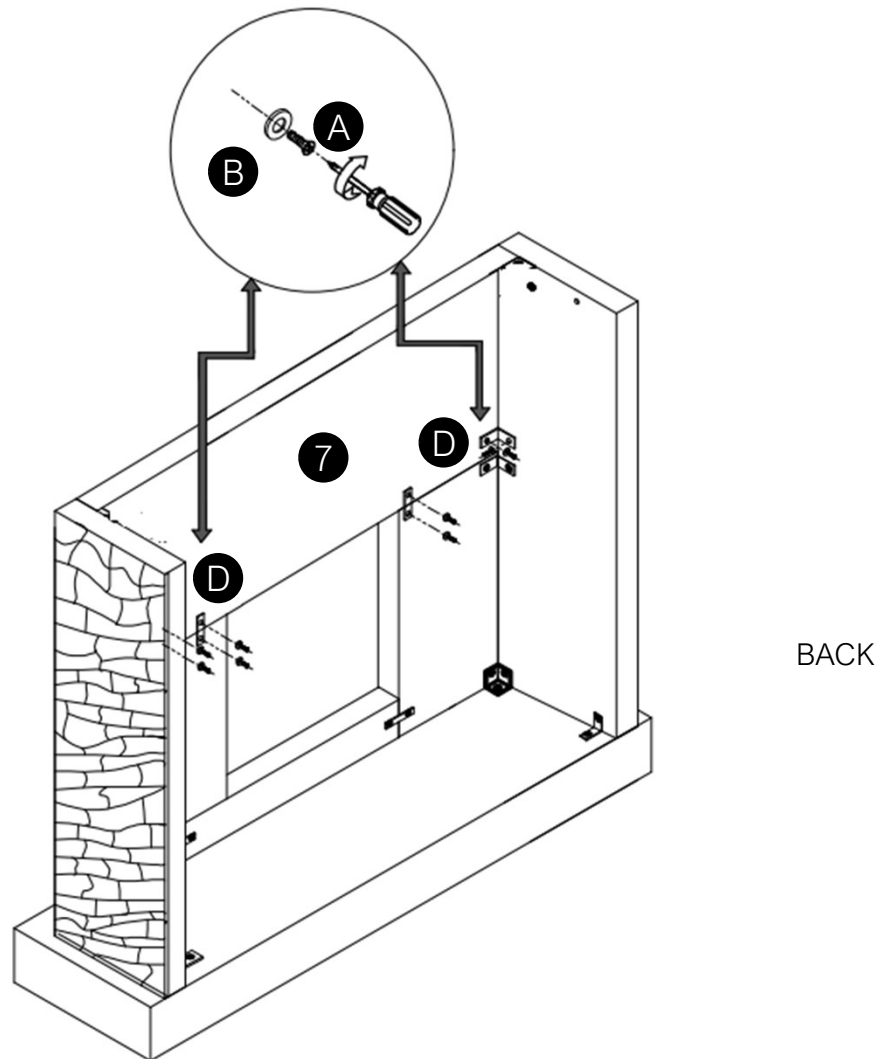

STEP 5

PART NO.	DESCRIPTION		QTY
A	Machine Screw		4
B	Washer		4
D	L-Bracket		2



Using 2 washers (B) and 2 screws (A) install an L-bracket into the top right corner of the assembled frame (1, 2, 3, 4, 5, 6 & 7). Repeat for the top left corner. Do not overtighten.

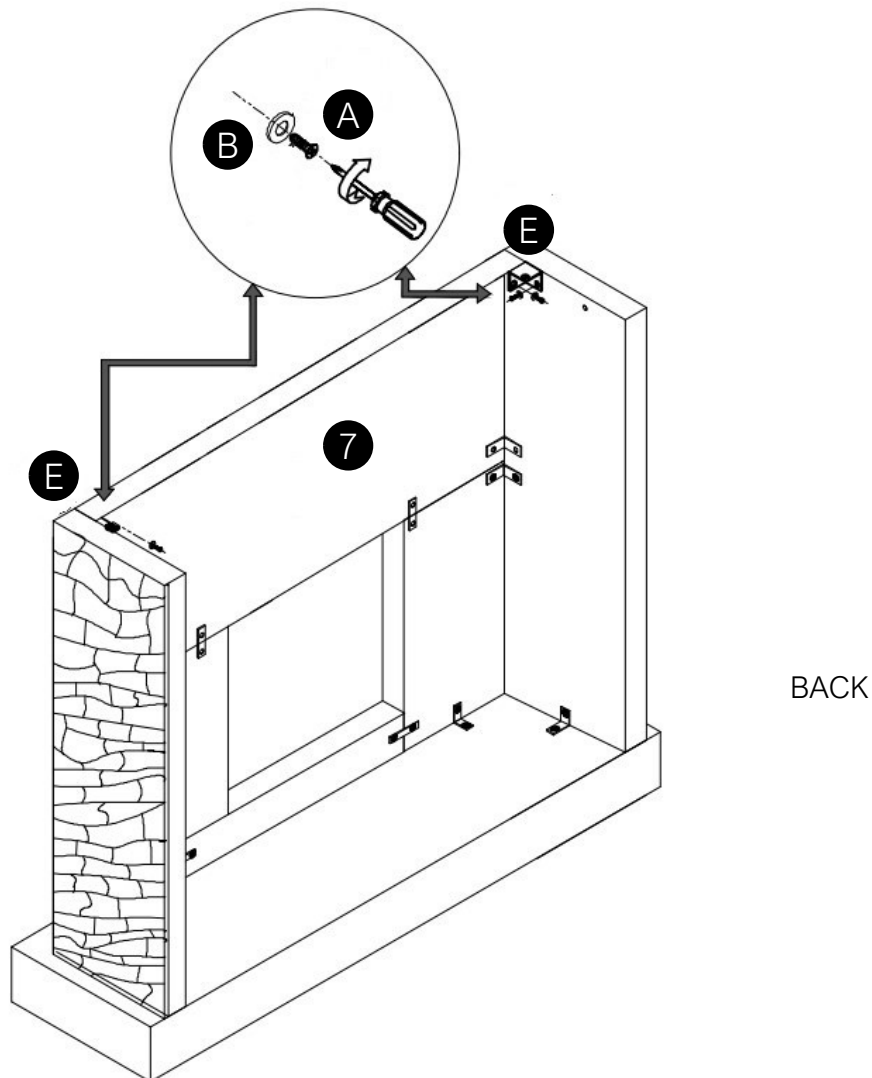

STEP 6

PART NO.	DESCRIPTION		QTY
A	Machine Screw		4
B	Washer		4
E	Top Corner Bracket		2



Install a top corner bracket (E) into the top right corner of the assembled frame (1, 2, 3, 4, 5, 6 & 7) using 2 washers (B) and 2 screws (A). Repeat for the top left corner. Do not overtighten.

STEP 7

PART NO.	DESCRIPTION		QTY
A	Machine Screw		8
B	Washer		8
D	L-Bracket		2

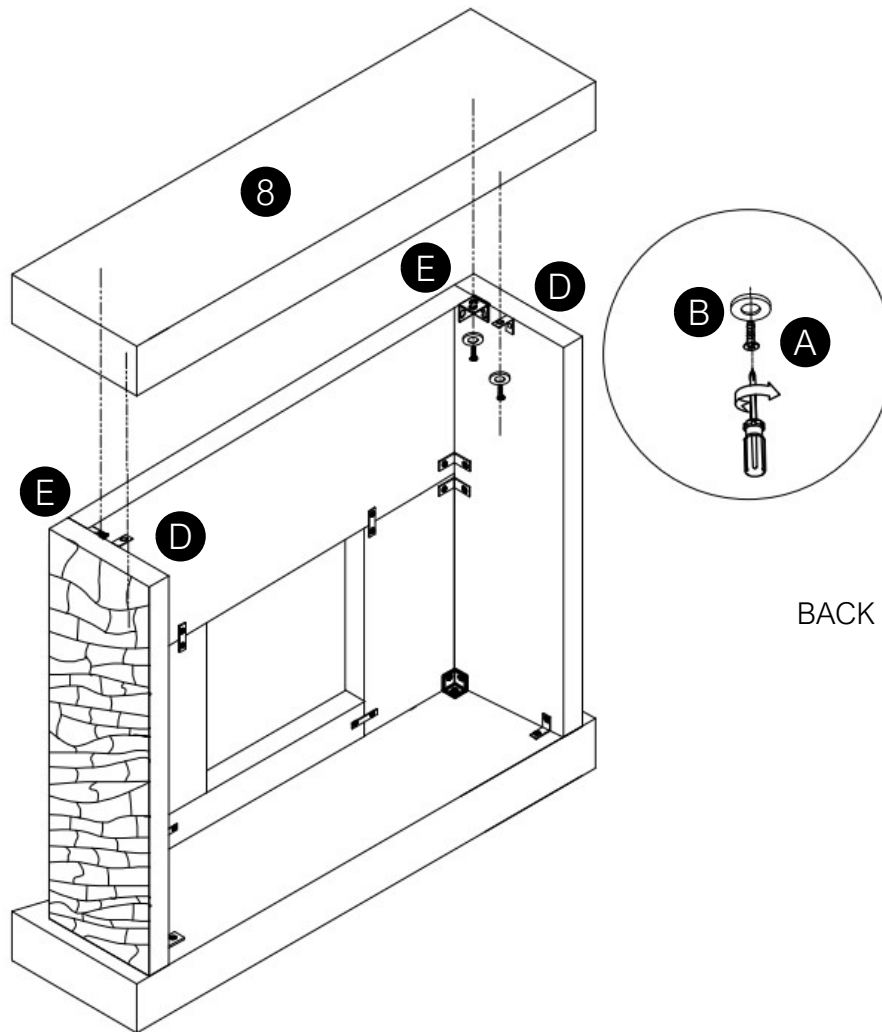

Attach the L-Brackets (D) to the side panels (5 & 6) with 2 washers (B) and 2 screws (A). Set the Top Shelf (8) onto the assembled frame (1, 2, 3, 4, 5, 6 & 7). Secure the Top Shelf (8) with the L-Brackets (D) and Top Corner Brackets (E) by installing 4 washers (B) and 4 screws (A). Do not overtighten.

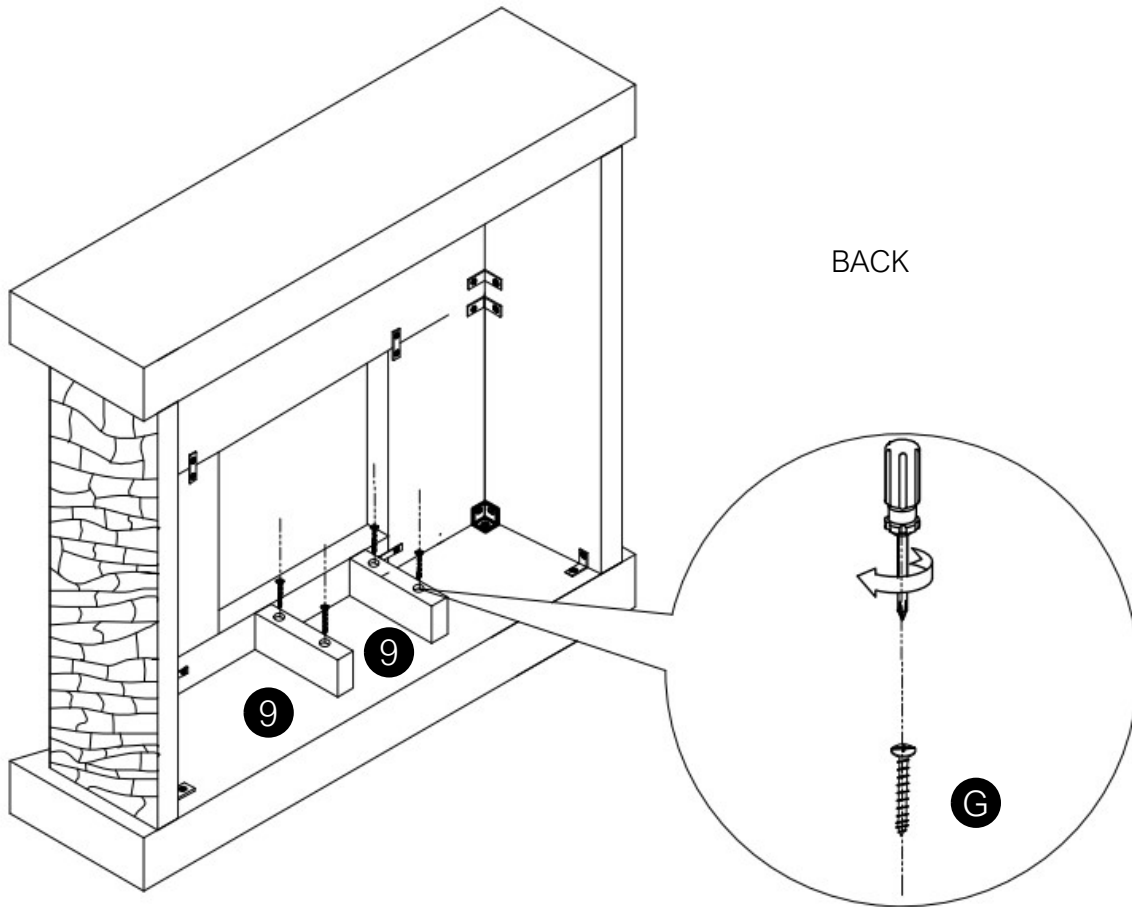

STEP 8

PART NO.	DESCRIPTION	QTY
G	Long Wood Screw 	4



Using 4 long wood screws (G), attach the 2 insert support rails (9) to the Hearth (4) as shown in the image above.

STEP 9

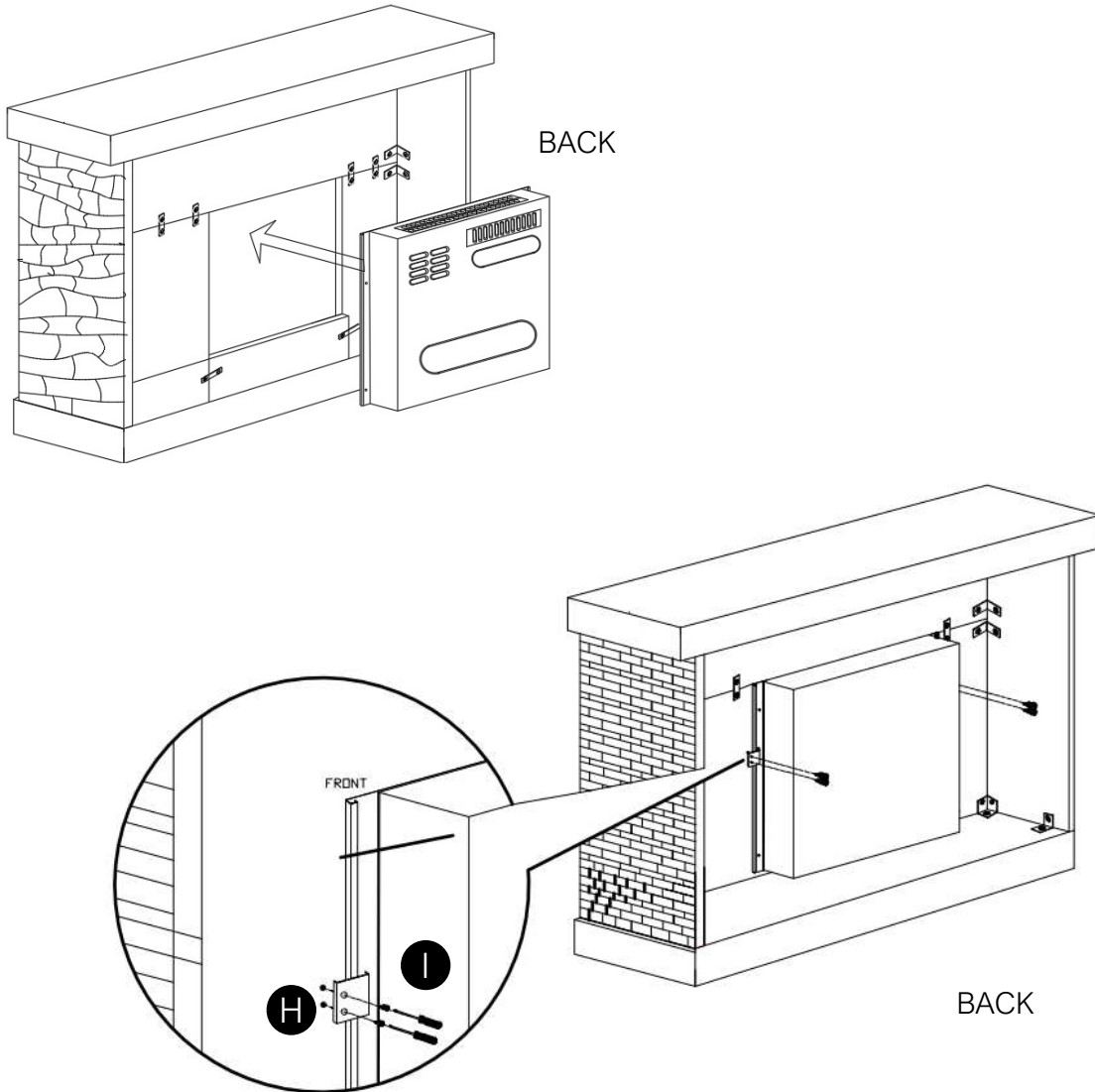

PART NO.	DESCRIPTION		QTY
H	Insert Connecting Plate		2
I	Short Wood Screw		4



From the back of the mantel, slide the insert, forward facing, into the opening. Make sure it is centered in the opening. Align the holes on the insert connecting plates (H) with the holes on the back side of the mantel. Secure the insert to the mantel with the 2 insert connecting plates (H) and screws (I).

STEP 10

WARNING: Anti-tipping hardware must be used to avoid tipping.

PART NO.	DESCRIPTION	QTY
J	Tie 	1
K	Bracket 	2

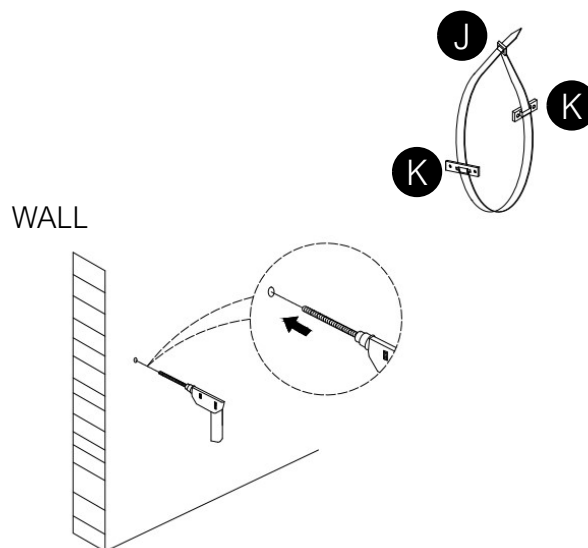

Drill 2 holes in the wall in the desired location for the mantel. Add the brackets to the tie as shown above.

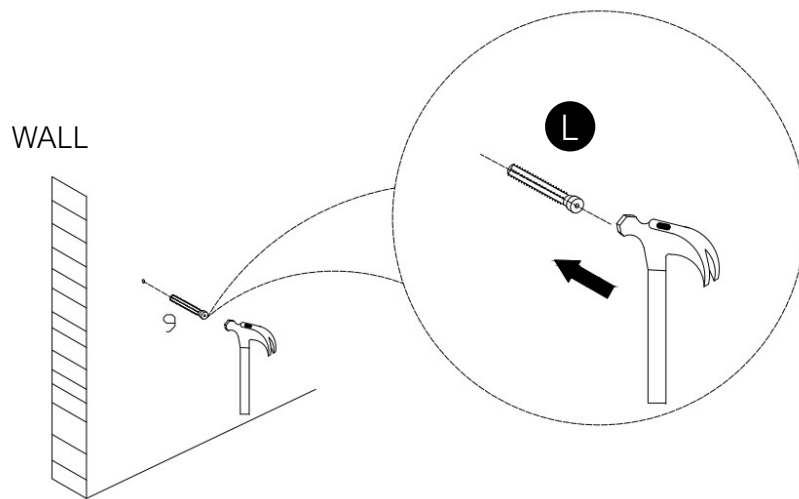

STEP 11

PART NO.	DESCRIPTION	QTY
L	Anchor 	2



Using a hammer, install 2 anchors (L) into the holes as shown.

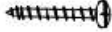

STEP 12

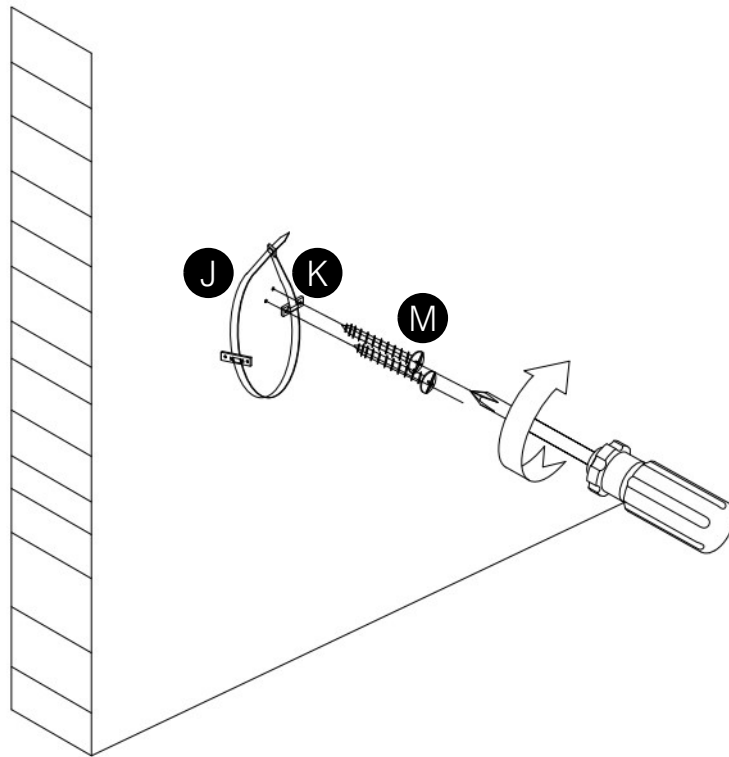
PART NO.	DESCRIPTION		QTY
J	Tie		1
K	Bracket		1
M	Long Screw		2



Attach a bracket (K), still connected to the tie (J), to the wall with 2 long screws (M).

STEP 13

PART NO.	DESCRIPTION		QTY
J	Tie		1
K	Bracket		1
N	Short Screw		2

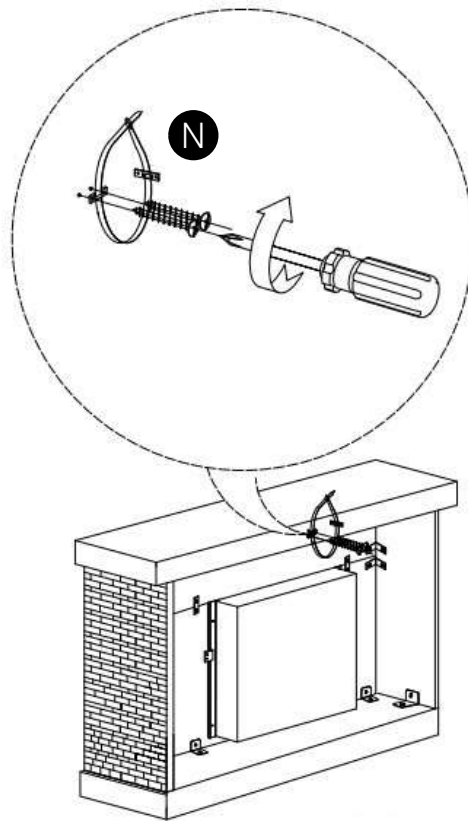

Move the fireplace to its desired location. Attach the second bracket (K) to the back of the fireplace mantel shelf with 2 short screws (N). Tighten the tie (J).

MODERN EMBER

Questions, problems, missing parts?
Before returning to store, call
Customer Service:
8am-5pm CST, Monday – Friday

Phone: 877-430-0703

Email: resolutions@electricfireplacesdirect.com

Please save these instructions for future reference.