

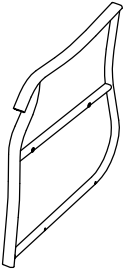

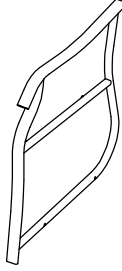

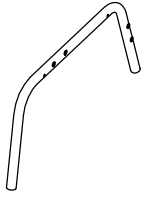

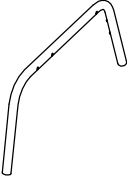

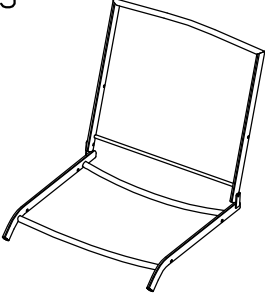
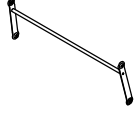
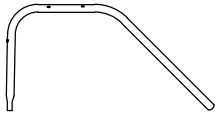
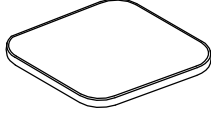
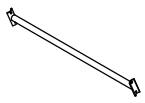



# ASSEMBLY INSTRUCTION

<p>A/2PCS</p> 	<p>B/2PCS</p> 	<p>C/2PCS</p> 
<p>D/2PCS</p> 	<p>E/2PCS</p> 	<p>F/4PCS</p> 
<p>H/4PCS</p> 	<p>I/1PC</p> 	<p>G/4PCS</p> 
<p>K/8PCS</p>  <p>M6*15</p>	<p>L/4PCS</p>  <p>M6*70</p>	<p>M/16PCS</p>  <p>M6*28</p>
<p>N/16PCS</p>  <p>M6*55</p>	<p>O/4PCS</p>  <p>M6*38</p>	<p>P/24PCS</p> 
<p>Q/72PCS</p> 	<p>R/48PCS</p> 	<p>S/24PCS</p> 
<p>T/16PCS</p> 	<p>AA/1PC</p> 	<p>BB/1PC</p> 
<p>STEP 1</p>  <p>STEP 2</p> 		

STEP 3

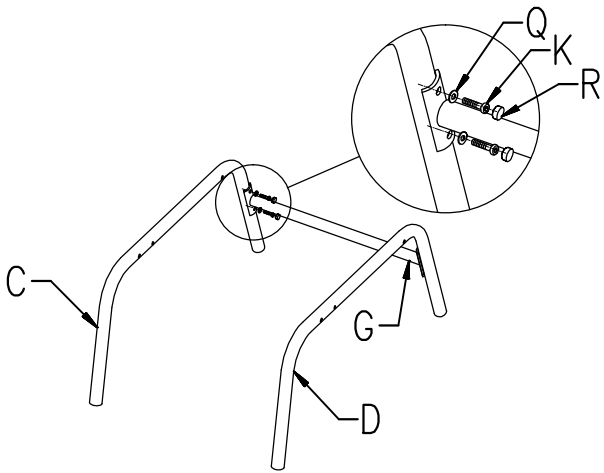
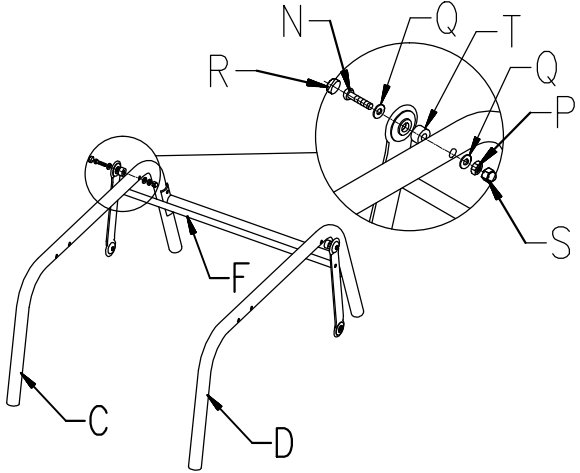
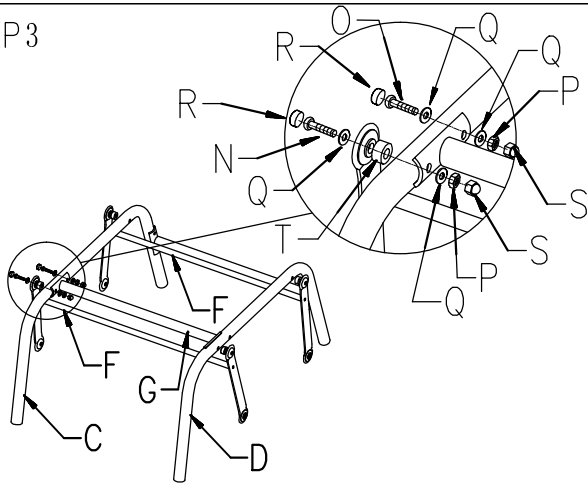

STEP 4

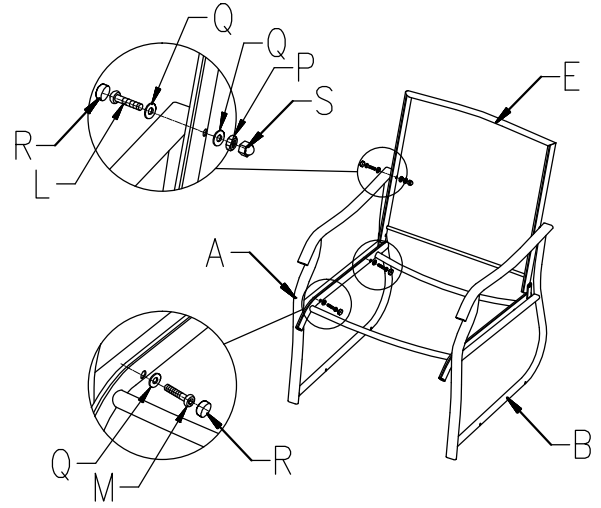

STEP 5

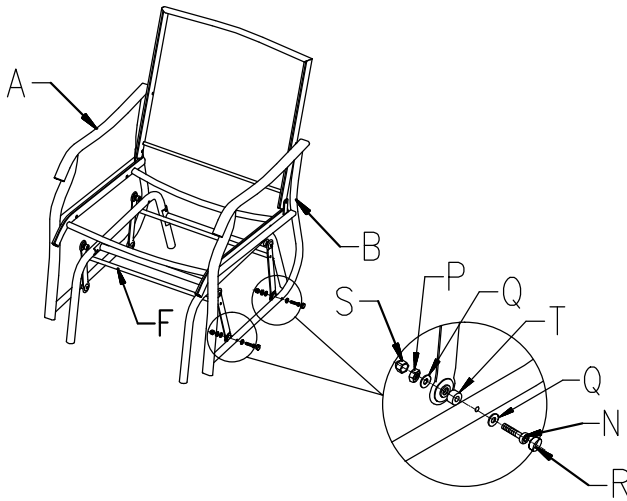

STEP 6

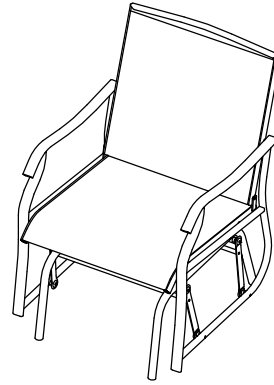

STEP 7

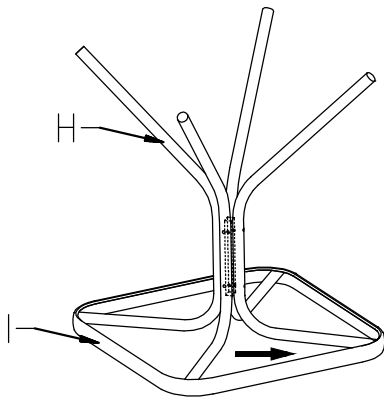

STEP 8

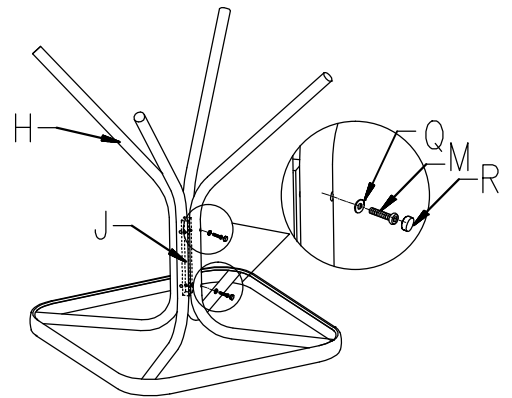

STEP 9

