

Assembly Instructions





IMPORTANT
READ THESE INSTRUCTIONS CAREFULLY BEFORE ASSEMBLING OR USING
YOUR ITEM
PLEASE KEEP THESE INSTRUCTIONS FOR LATER REFERENCE

HEALTH & SAFETY:

DO NOT use this item if any parts are missing, damaged or worn.
DO NOT use this item unless all fixings are secured.
Please keep small parts out of reach of children.
Always use on a level, even surface.
It is recommended that two people handle and assemble the item.

CARE & MAINTENANCE:

Assemble in the room of use.
To avoid damages assemble the item on a soft, clean surface.
Periodically check all screws & fixings to ensure they are secure.
DO NOT push the item as this will damage the base.
Always lift the item with two people to reposition.
Keep any sharp objects away from the item.
On unpacking the item you may notice an odour due to production processes but this will disappear after a period of time.
DO NOT place the item next to a radiator or direct sunlight—this item is susceptible to temperature change.
It is recommended an even room temperature be maintained with no sudden fluctuations.
DO NOT place hot or cold items directly onto the surface of the item as marking will occur. For general cleaning use a duster or damp cloth (almost dry) not wet—do not use soap and water, detergents, aerosol sprays or any polish as use of these materials would invalidate any claims.
DO NOT place the item onto wet or damp flooring as staining may occur to the floor.



WICHTIG
LESEN SIE DIESE BEDIENUNGSANLEITUNG SORGFÄLTIG DURCHFÜHREN
YOUR ITEM
BITTE KEEP THESE BEDIENUNGSANLEITUNG FÜR KÜNFTIGE REFERENZEN.

GESUNDHEIT & SICHERHEIT:

Verwenden Sie diesen Artikel NICHT, wenn Teile fehlen, beschädigt oder verschlissen sind.
Verwenden Sie diesen Artikel NICHT, wenn nicht alle Befestigungen gesichert sind.
Bitte halten Sie kleine Teile außerhalb der Reichweite von Kindern.
Immer auf einer ebenen, ebenen Oberfläche verwenden.
Es wird empfohlen, dass zwei Personen den Gegenstand behandeln und zusammenbauen.

PFLEGE & WARTUNG:

Zusammenbau im Raum der Nutzung.
Um Beschädigungen zu vermeiden, montieren Sie den Gegenstand auf einer weichen, sauberen Oberfläche.
Überprüfen Sie regelmäßig alle Schrauben und Befestigungen, um sicherzustellen, dass sie sicher sind.
NICHT drücken Sie das Element, da dies die Basis beschädigen wird.
Heben Sie immer das Einzelteil mit zwei Leuten an, um zu repositionieren.
Halten Sie alle scharfen Gegenstände von der Gegenstände fern.
Beim Auspacken des Artikels können Sie einen Geruch aufgrund von Produktionsprozessen feststellen, aber das verschwindet nach einer gewissen Zeit.
Setzen Sie das Objekt nicht direkt auf einen Kühler oder ein direktes Sonnenlicht - dieses Element ist anfällig für Temperaturänderung.
Es wird empfohlen, eine gleichmäßige Raumtemperatur ohne plötzliche Schwankungen zu erhalten.
Setzen Sie keine heißen oder kalten Gegenstände direkt auf die Oberfläche des Gegenstandes, wenn die Markierung auftritt. Für die allgemeine Reinigung verwenden Sie ein Staubtuch oder ein feuchtes Tuch (fast trocken) nicht nass - verwenden Sie keine Seife und Wasser, Waschmittel, Aerosol Sprays oder irgendein Polnisch, da die Verwendung dieser Materialien irgendwelche Ansprüche ungültig machen würde.
Setzen Sie das Produkt NICHT auf nassen oder feuchten Boden, da die Färbung auf dem Boden auftreten kann.



IMPORTANTE
LEA ESTAS INSTRUCCIONES CUIDADOSAMENTE PARA NO REEMPLAZAR O USAR
YOUR ARTÍCULO
POR FAVOR GUARDE LAS INSTRUCCIONES PARA REFERENCIA FUTURA.

SALUD Y SEGURIDAD:

NO utilice este artículo si faltan piezas, están dañadas o desgastadas.
NO use este artículo a menos que todas las fijaciones estén aseguradas.
Por favor, mantenga las piezas pequeñas fuera del alcance de los niños.
Utilícelo siempre en una superficie nivelada y uniforme.
Se recomienda que dos personas manejen y ensamblen el artículo.

CUIDADO Y MANTENIMIENTO:

Montar en la sala de uso.
Para evitar daños ensamble el artículo sobre una superficie suave y limpia.
Revise periódicamente todos los tornillos y fijaciones para asegurarse de que estén seguros.
NO empuje el artículo ya que esto dañará la base.
Siempre levante el artículo con dos personas para reubicarlo.
Mantenga los objetos afilados lejos del objeto.
Al desensamblar el artículo puede notar un olor debido a los procesos de producción, pero esto desaparecerá después de un periodo de tiempo.
NO coloque el artículo cerca de un radiador o de la luz solar directa; este elemento es susceptible al cambio de temperatura.
Se recomienda mantener una temperatura ambiente uniforme sin fluctuaciones repentinas.
NO coloque objetos calientes o fríos directamente sobre la superficie del artículo ya que se producirá un marcado. Para limpieza general use un plumero o un paño húmedo (casi seco) no húmedo no utilice jabón y agua, detergentes, aerosoles o cualquier pulido, ya que el uso de estos materiales invalidaría cualquier reclamo.
NO coloque el artículo sobre suelos mojados o húmedos, ya que pueden producirse manchas en el piso.



IMPORTANT
LISEZ CES INSTRUCTIONS ATTENTIVEMENT AVANT DE MODÉRER OU D'UTILISER
YOUR ARTICLE
VEUILLEZ CONSERVER LES INSTRUCTIONS POUR UNE RÉFÉRENCE FUTURE.

SANTÉ ET SÉCURITÉ:

N'utilisez PAS cet article si des pièces sont manquantes, endommagées ou usées.
N'utilisez PAS cet objet que si toutes les fixations sont sécurisées.
Gardez les petites parties hors de portée des enfants.
Utilisez toujours sur un plan, même sur une surface.
Il est recommandé que deux personnes manipulent et assemblent l'objet.

SOINS ET MAINTENANCE:

Assembler dans la salle d'utilisation.
Pour éviter tout dommage, assembler l'objet sur une surface douce et propre.
Vérifiez périodiquement toutes les vis et les fixations pour s'assurer qu'elles sont sécurisées.
NE PAS pousser l'objet car cela pourrait endommager la base.
Solevez toujours l'élément avec deux personnes pour repositionner.
Gardez les objets tranchants loin de l'objet.
Lors du déballage de l'article, vous pouvez remarquer une odeur due aux processus de production, mais cela disparaîtra après une période de temps.
NE PAS placer l'objet à côté d'un radiateur ou d'une lumière directe du soleil; cet élément est susceptible de changer la température.
Il est conseillé de maintenir une température ambiante homogène sans fluctuations brusques.
NE PAS placer d'objets chauds ou froids directement sur la surface de l'objet car un marquage se produira. Pour un nettoyage général, utilisez un chiffon ou un chiffon humide (presque sec) non humide - ne pas utiliser du savon et de l'eau, des détergents, des pulvérisations d'aérosol ou un vernis car l'utilisation de ces matériaux invaliderait toute réclamation.
NE PAS placer l'objet sur un sol humide ou mouillé, car des colorations peuvent survenir au sol.



IMPORTANTE
LEGGERE QUESTE ISTRUZIONI ATTENZIONAMENTE PREVIARSI ALL'USO
YOUR VOCE
CONSERVARE ISTRUZIONI PER LA RIFERIMENTO FUTURO.

SALUTE E SICUREZZA:

NON usare questo articolo se manca, è danneggiato o indossato.
NON utilizzare questo elemento a meno che tutti i fissaggi non siano fissati.
Si prega di tenere le piccole parti fuori dalla portata dei bambini.
Utilizzare sempre su un piano, anche su superficie.
Si raccomanda che due persone gestiscano e assemblino l'elemento.









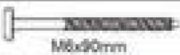

CURA E MANUTENZIONE:







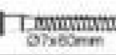

Assemblare nella stanza d'uso.
Per evitare danni, montare l'elemento su una superficie morbida e pulita.
Controllare periodicamente tutte le viti e i fissaggi per assicurarsi che siano sicuri.
NON spingere l'elemento in quanto ciò danneggerà la base.
Sollevarlo sempre l'elemento con due persone per riposizionare.
Tenere tutti gli oggetti taglienti lontani dall'elemento.
Scomponendo l'elemento si nota un odore dovuto ai processi produttivi, ma questo scompare dopo un certo periodo di tempo.
NON collocare l'elemento vicino ad un radiatore o alla luce diretta del sole - questo elemento è soggetto a variazioni di temperatura.
Si consiglia di mantenere una temperatura ambiente uniforme senza oscillazioni improvvise.
NON collocare oggetti caldi o freddi direttamente sulla superficie dell'elemento quando si verifica la marcatura. Per la pulizia generale usare un panno umido (quasi asciutto) non bagnato - non utilizzare sapone e acqua, detergenti, spray aerosol o qualsiasi polacco come uso di questi materiali potrebbero invalidare qualsiasi rivendicazione.
NON collocare l'elemento su pavimentazione bagnata o umida, in quanto la colorazione può verificarsi al pavimento.

Assembly Instructions

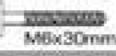
up: 90x190cm
down: 140x190cm

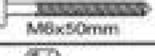

A			38
B			40
C		28x30mm	44
D			2
E			66
F			16
G			18

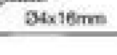
H			4
J			6
K		12 x 80mm	4
L			10
M			2
N			2
O			6

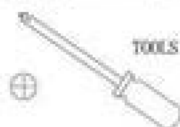

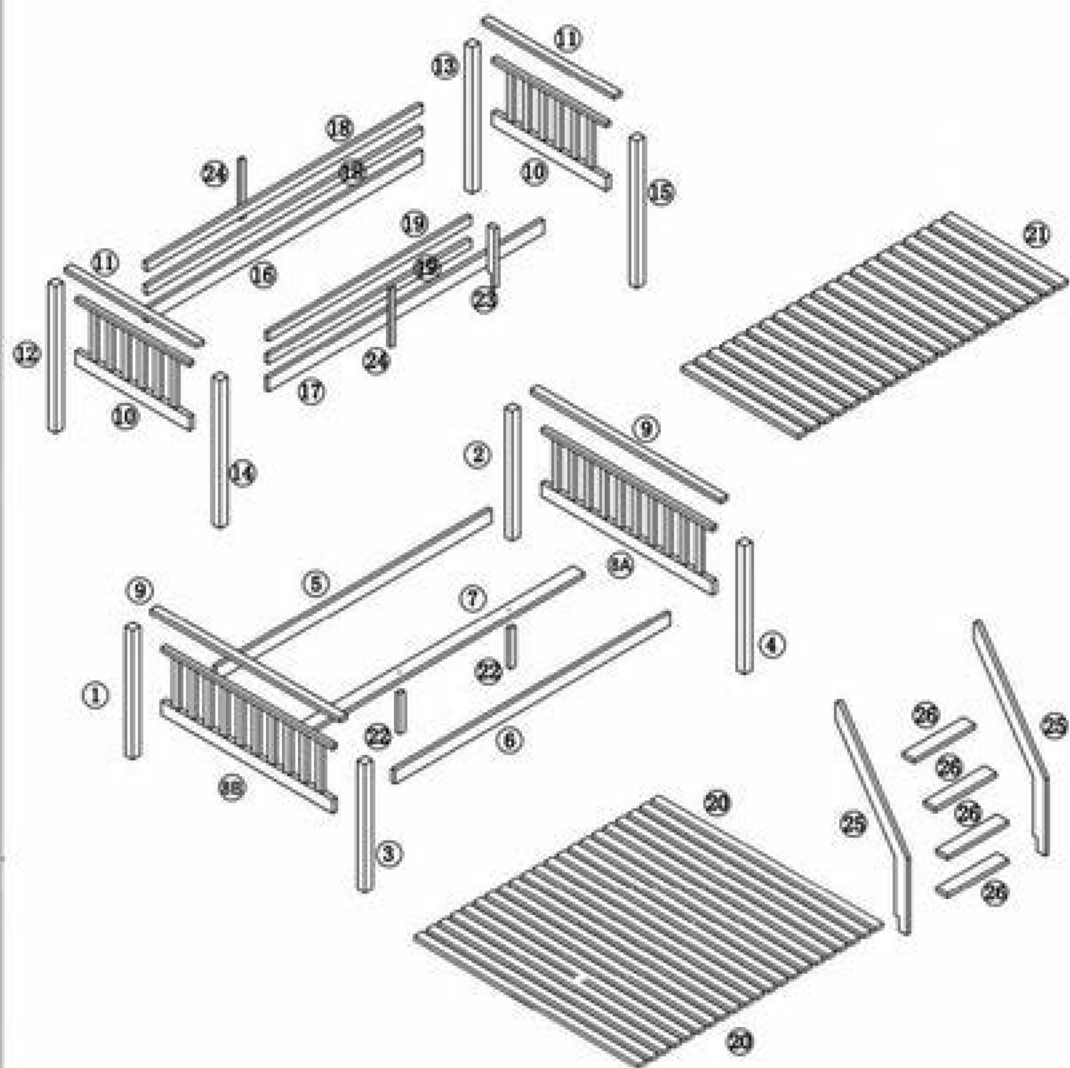

TOOLS REQUIRED

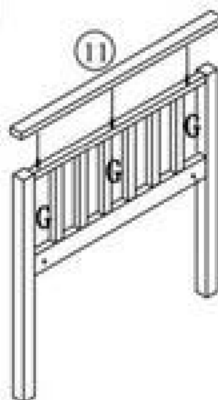
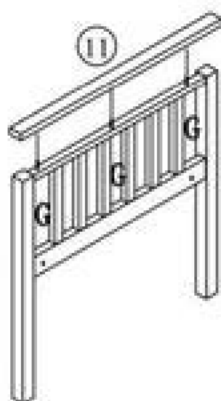
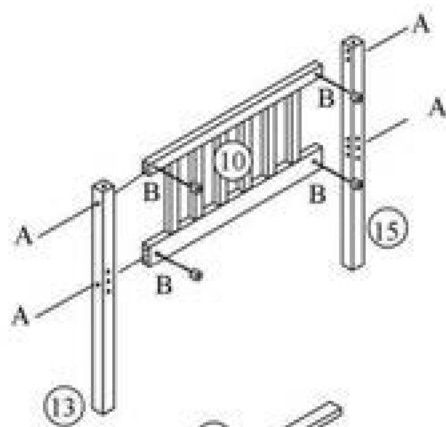
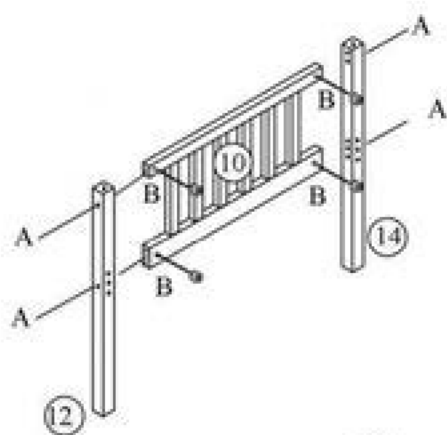
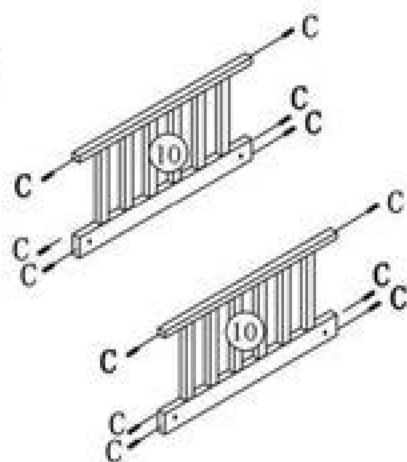
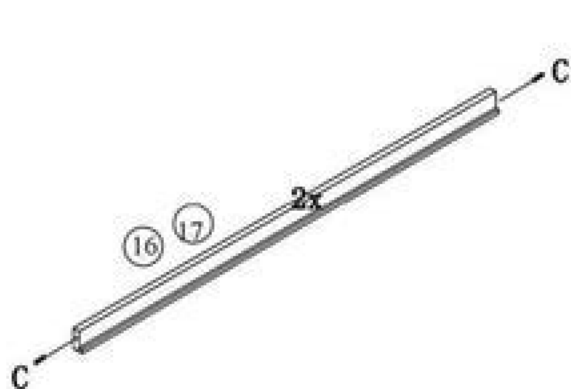



P 3/8

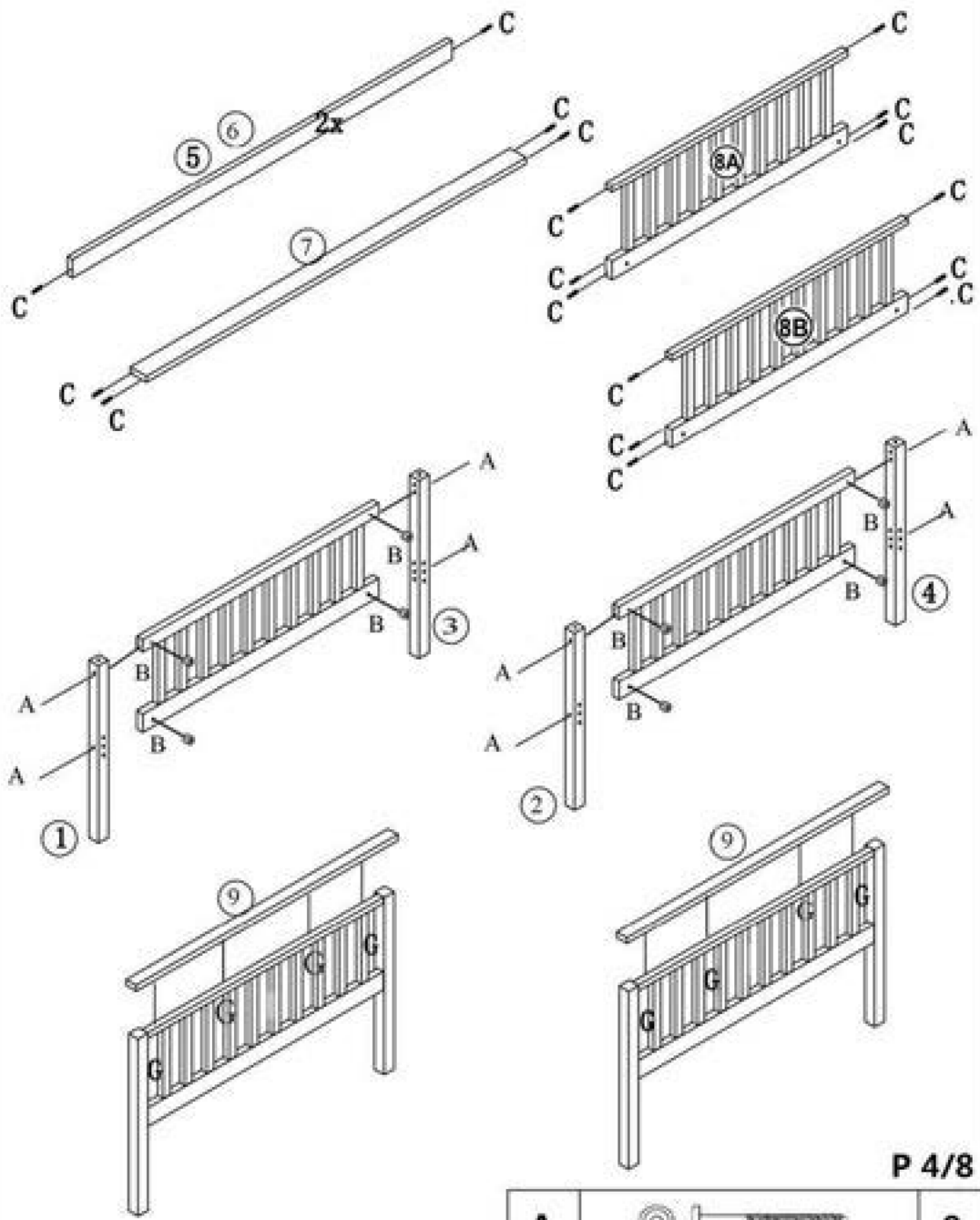

C	 28x30mm	16
----------	--	-----------

A	 15mm M6x90mm	8
B		8
G	 18mm M6x70mm	6





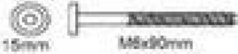

P 4/8

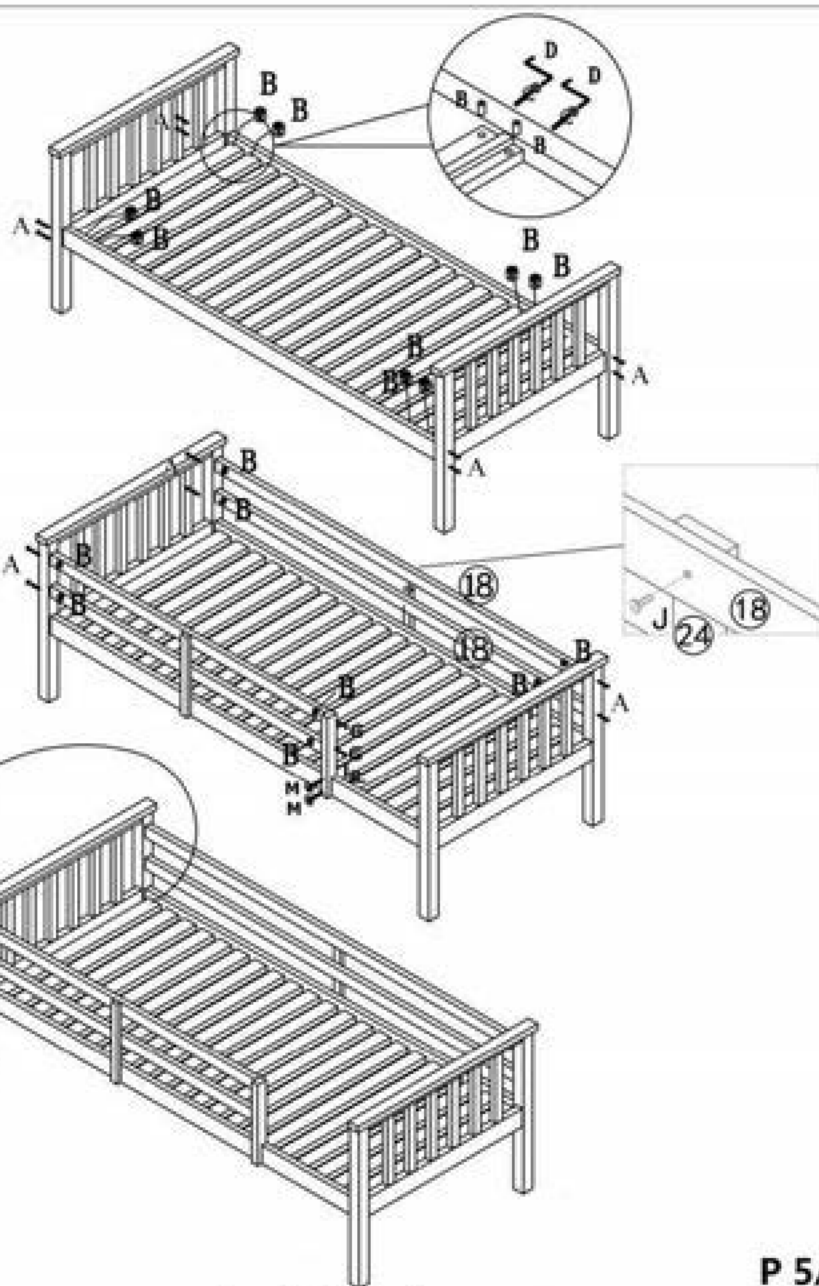





C	 Ø8x30mm	20
----------	--	-----------

A	 15mm M6x90mm	8
B		8
G	 15mm M6x70mm	8



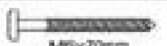

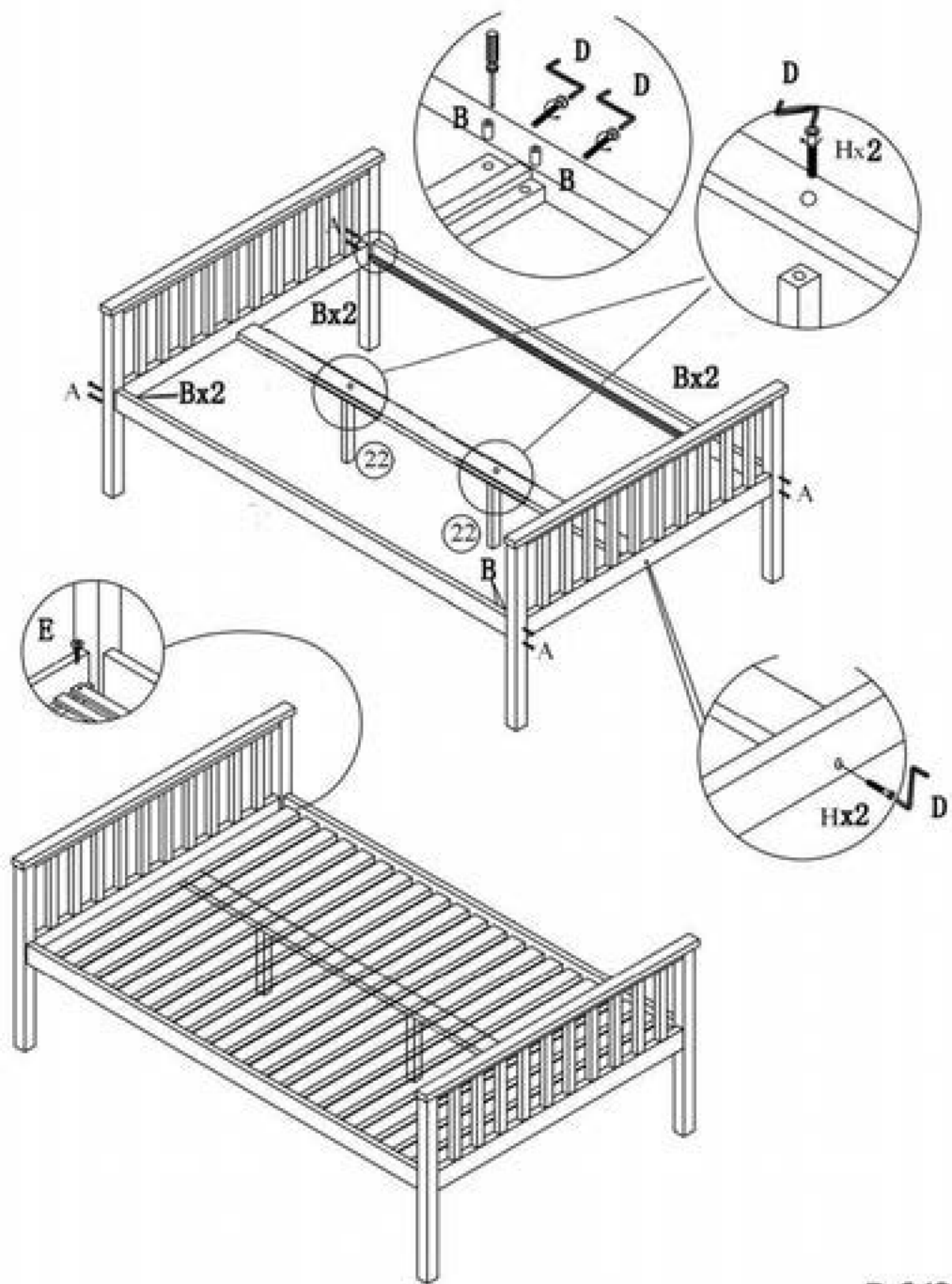

P 5/8

C	 Ø8x30mm	8
B		16
M	 15mm	2
L	 15mm	8

A	 15mm	 M6x90mm	14
G	 15mm	 M6x70mm	2
E	 8mm	 Ø4x30mm	30
J	 15mm	 M6x30mm	6



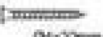

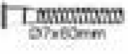

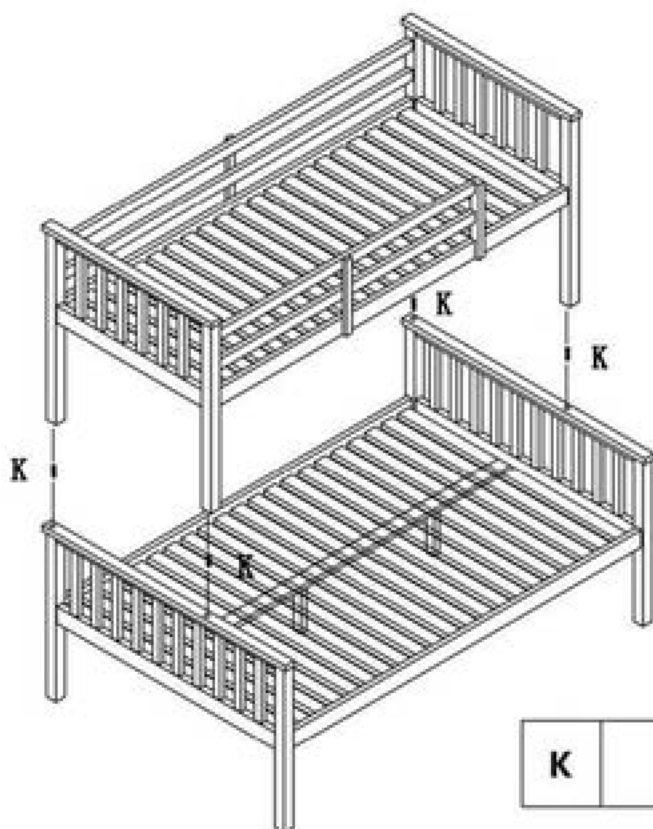
P 6/8

A	  15mm M6x90mm	8	E	  6mm Ø4x30mm	30
B		8	H	  10mm Ø7x60mm	4

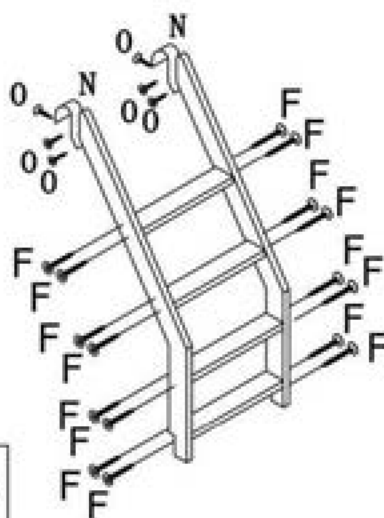







K	 Ø 13x49mm	4
---	---	---



F	 13/16in M6x70mm	16
N		2
O	  7mm Ø4x16mm	6

P 7/8



E	 	6
G	 	2
L	 	2



IMPORTANT, RETAIN FOR FUTURE REFERENCE, READ CAREFULLY

ASSEMBLY:

Current legislation requires that the bunk bed must be fitted with 4 safety-rails and a ladder or platform for the upper bunk bed.

The bunk bed meets the European BS EN 747-1:2012+A1:2015 & BS EN 747-2:2012+A1:2015 standards for security and durability.

MATTRESS:

This bed is designed to use a mattress size 140x190 cm and 90x190 cm. The total thickness must not exceed 10 cm. The mattress top must not pass the marking on the post for safetyrail.

IMPORTANT:

Be aware of the danger of young children (under 6 years) falling from the upper bunk. Do not use the bed if any structural part is broken or missing. Children can become trapped between the bed and the wall. To avoid risk of serious injury the distance between the top safety barrier and the wall shall not exceed 75mm or shall be more than 230 mm.

Strangulation hazard-never attach or hang items to any part of the bunk bed that are not designed for use with the bed; for example, but not limited to, ropes, sreings, cords, harnesses and belts.

Always follow the manufacturer's instructions.

Ventilation of the room is necessary in order to keep the humidity low and to prevent mould in and around the bed.

MAINTENANCE INSTRUCTIONS:

Screws and bolts should from time to time be retightened.